

# IS30<sup>TM</sup>

USER MANUAL EN

347492 B





## CONTENTS

<b>SAFETY</b>	<b>1-10</b>
SAFETY PRECAUTIONS .....	1
WARNINGS .....	2
ADDITIONAL SAFETY INFORMATION .....	9
<b>EU DECLARATION OF CONFORMITY</b>	<b>11</b>
<b>CB TEST CERTIFICATE</b>	<b>12</b>
<b>IMPORTANT ISOCYANATE INFORMATION</b>	<b>13-14</b>
GENERAL HANDLING GUIDELINES .....	13
MATERIAL SELF IGNITION .....	14
FOAM RESINS W/245 FA BLOWING AGENTS .....	14
CHANGING MATERIALS .....	14
ELECTRICAL GROUND .....	14
<b>INTELLISPRAY SYSTEM OVERVIEW</b>	<b>15-16</b>
<b>IS30 SPECIFICATIONS</b>	<b>17-18</b>
<b>IS30 OVERVIEW</b>	<b>19-20</b>
<b>FLUID MODULE</b>	<b>21-30</b>
MODULE ASSEMBLIES-OVERVIEW .....	24
MODULE FLUID PATHWAYS .....	25
FILTER MODULE .....	26
LOW PRESSURE MODULE .....	27
PUMP MODULE .....	28
HIGH PRESSURE MODULE .....	29
<b>CONTROL MODULE</b>	<b>31-38</b>
CONTROL MODULE-OVERVIEW .....	32
CONTROL MODULE-ENCLOSURE .....	33
<b>CIRCUIT BREAKERS</b>	<b>39-40</b>
<b>QUICKHEAT™ HOSE-OVERVIEW</b>	<b>41-42</b>
<b>INSTALLATION-OVERVIEW</b>	<b>43</b>
<b>INSTALLATION PROCEDURE</b>	<b>44-50</b>
<b>QUICK-START GUIDE</b>	<b>51-52</b>
<b>INTELLISPRAY OPERATION TIPS</b>	<b>53</b>
<b>DISPLAY SCREENS</b>	<b>55-154</b>
DISPLAY SCREENS-OVERVIEW .....	55

IS30 DISPLAY SPECIFICATIONS .....	55
SPRAY SCREEN-OVERVIEW .....	57
SPRAY SCREEN-USER INFORMATION .....	58
SPRAY SCREEN-USER ACTIONS .....	59
SPRAY SCREEN-USE.....	60
SPRAY SCREEN-OTHER FUNCTIONS.....	63
DRUM TEMPERATURE .....	63
FLUID COUNTER.....	63
FLUID.....	63
FLOW RATE AND TRIGGER %.....	63
ALARMS.....	64
RESET .....	64
PREHEATER TEMPERATURE OFFSET.....	64
ALARM DETAILS.....	65
INLET COMPENSATION.....	66
AUTOMATIC VISCOSITY COMPENSATION (AVC™) .....	67
AUTOMATIC INLET COMPENSATION (AIC) .....	69
EXCHANGE SCREEN-OVERVIEW.....	70
EXCHANGE SCREEN-USE .....	71
EXAMPLE 1-INITIAL SYSTEM BLEED .....	75
EXAMPLE 2-A SIDE MANUAL PURGE .....	77
EXAMPLE 3-B SIDE PURGE AMOUNT .....	79
EXAMPLE 4-PREHEAT B DRUM MATERIAL .....	81
EXAMPLE 5-SIDE AIR PURGE .....	83
ALARM SCREEN-OVERVIEW .....	86
ERRORS .....	86
ALARM SCREEN-USE.....	87
SYSTEM STATUS SCREENS-OVERVIEW .....	91
SYSTEM STATUS SCREENS-IO PAGE1 .....	92
SYSTEM STATUS SCREENS-IO PAGE2.....	93
SYSTEM STATUS SCREENS-SENSOR BYPASS.....	96
SYSTEM STATUS SCREENS-INLET HEALTH .....	98
SYSTEM STATUS SCREENS-TREND CHARTS .....	101



SYSTEM STATUS SCREENS-TREND CHARTS .....	101
SELECT PLOT PARAMETERS .....	102
SELECT TIME SCALE (TREND TIME) .....	104
SETTINGS SCREENS-OVERVIEW .....	105
SETTINGS SCREENS-SYSTEM INFORMATION .....	106
SETTINGS SCREENS-FIRMWARE UPDATES .....	107
SETTINGS SCREENS-SYSTEM STATUS .....	108
SETTINGS SCREENS-CONFIGURATION SETTINGS .....	109
SETTINGS SCREENS-DISPLAY SETTINGS .....	110
SETTINGS SCREENS-SYSTEM SETTINGS .....	111
SETTINGS SCREENS-HOSE CONFIGURATION .....	112
SETTINGS SCREENS-DRIVE STATUS LOG .....	116
SETTINGS SCREENS-SUPPLY SETTINGS .....	117
SETTINGS SCREENS-PREHEATERS .....	118
SETTINGS SCREENS-YIELD CALCULATOR .....	119
SETTINGS SCREENS-MATERIAL DATA .....	122
SECURITY .....	124
RECIPE SCREENS-OVERVIEW .....	128
RECIPE SCREENS-MANAGEMENT .....	133
RECIPE SCREENS-EDITING .....	137
REPORTS-OVERVIEW .....	139
REPORTS-AUDIT REPORT .....	140
REPORTS-JOB NOTES .....	142
JOB REPORTS-OVERVIEW .....	143
JOB REPORTS-LOG ENTRIES .....	146
JOB REPORTS-MATERIAL DATA .....	147
JOB REPORTS-REPORT CONTENT .....	148
JOB REPORTS-REPORT MANAGEMENT .....	149
LANGUAGES .....	151
VARIABLE RATIO OPERATION .....	152
VARIABLE RATIO OPERATION-ENABLE VARIABLE RATIO .....	152
VARIABLE RATIO OPERATION-ENABLE FIRST TIME .....	153
<b>SERVICING</b> .....	<b>155-158</b>
QUICKHEAT™ HOSE CONNECTION .....	156
BURST DISK REPLACEMENT .....	157
FILTER MAINTENANCE .....	158
<b>TROUBLESHOOTING</b> .....	<b>159-170</b>
SYSTEM ERRORS AND ACTION .....	159

<b>MAINTENANCE</b>	<b>171-192</b>
REGULAR MAINTENANCE PROCEDURES & RECOMMENDATIONS	171
FLUID MODULE ITEMS .....	172
LOW PRESSURE MODULE .....	174
PUMP MODULE .....	176
HIGH PRESSURE MODULE .....	178
PUMP I/O MODULE.....	180
FLUID MODULE O-RINGS AND SEALS .....	182
CONTROL MODULE ENCLOSURE .....	184
CONTROL MODULE 200-240V .....	186
CONTROL MODULE 380-415V .....	188
CABLES .....	192
<b>SCHEMATICS</b>	<b>193-236</b>
ELECTRICAL DIAGRAMS 200-240V .....	193
ELECTRICAL DIAGRAMS 380-415V .....	215
<b>REMOTE ACCESS</b>	<b>237-240</b>
<b>MANUAL REVISIONS</b>	<b>241-242</b>
<b>WARRANTY</b>	<b>243</b>

## SAFETY

### SAFETY PRECAUTIONS

Before the operation, maintenance, or servicing of this Carlisle Fluid Technologies system, fully read and understand all technical and safety literature for your IntelliSpray products. This manual contains information that is important for you to know and understand.

**This information relates to USER SAFETY and the PREVENTION OF EQUIPMENT PROBLEMS.**

To help you understand this information, we use recognizable ANSI Z535 and ISO warning boxes and symbols throughout this manual. Please obey these safety sections.

#### **DANGER**

**DANGER!**: Indicates a hazardous situation that, if not avoided, will result in death or serious injury.

#### **WARNING**

**WARNING!**: Indicates a hazardous situation that, if not avoided, could result in death or serious injury.

#### **CAUTION**

**Caution!**: Indicates a hazardous situation that, if not avoided, could result in minor or moderate injury or equipment damage.

#### **NOTICE**

**Notice:** Indicates information considered important but not hazard related.

#### **SAFETY**

**Safety:** Indicates a type of safety instruction, or a separate panel on a safety, where specific safety-related instructions or procedures are described.

This manual lists standard specifications and service procedures. Minor differences can occur between this literature and your equipment. Differences in local or municipal codes, manufacturer or plant requirements, material delivery requirements, and more can make variations unpreventable. Compare this manual to your system installation drawings and other applicable IntelliSpray equipment manuals to find these differences.

Careful study and continued use of this manual will provide a better understanding of the equipment functions and procedures.

This will result in improved operation, efficiency, and longer, trouble-free service with faster and easier troubleshooting. If you need the necessary manuals and safety literature for your specific IntelliSpray system, contact your local IntelliSpray representative or IntelliSpray directly.

#### **WARNING**

The user **MUST** read and be familiar with the Safety Section in this manual and the safety literature therein identified.

This equipment is intended to be used by trained personnel **ONLY**.

This manual **MUST** be read and thoroughly understood by **ALL** personnel who operate, clean or maintain this equipment! Special care should be taken to ensure that the **WARNINGS** and safety requirements for operating and servicing the equipment are followed.

The user should be aware of and adhere to **ALL** local building and fire codes and ordinances as well as **NFPA 33 AND EN 16985 SAFETY STANDARDS, LATEST EDITION**, or applicable country safety standards, prior to installing, operating, and/or servicing this equipment.

#### **WARNING**

The hazards shown on the following pages may occur during the normal use of this equipment.

**Repairs may only be performed by personnel authorized by Carlisle Fluid Technologies.**

## WARNINGS

Spray Foam equipment and materials operate under high pressure and temperature and should only be used by trained professionals. The fluids used to create polyurethane foam insulation are hazardous. Unprotected exposure during handling and use may cause lung, ear,

and/or skin irritation, shortness of breath, sore throat, fever, and even permanent respiratory and/or skin damage and/or sensitization. Always refer to the Material Safety Data Sheets for proper handling, transportation, storage, and disposal.

### ⚠ WARNING

**Read and understand all the warnings in this section and elsewhere in this manual.**



**READ THE MANUAL** Before operating this equipment, read and understand all safety, operation, and maintenance information in the operation manual.



**TIP/CRUSH HAZARD** Do not tip the unit. In mobile or seismic installations be sure the unit is secured to the floor and wall per instructions.



**OPERATOR TRAINING** All personnel must be trained before operating this equipment.



**EQUIPMENT MISUSE HAZARD** Equipment misuse can cause the equipment to rupture, malfunction, or start unexpectedly resulting in serious injury.



**NEVER MODIFY THE EQUIPMENT** Do not modify the equipment unless the manufacturer provides written approval.



**KNOW WHERE AND HOW TO SHUT OFF THE EQUIPMENT IN CASE OF AN EMERGENCY**



**AUTOMATIC EQUIPMENT** Automatic equipment may start suddenly without warning.



**LOCKOUT-TAGOUT** Failure to de-energize, disconnect, lockout and tagout all power sources before performing equipment maintenance could cause serious injury or death.



**WEAR SAFETY GLASSES** Failure to wear safety glasses with side shields could result in serious eye injury or blindness.



**WEAR A RESPIRATOR** Toxic fumes can cause serious injury or death if inhaled. Wear a respirator as recommended by the fluid and solvent manufacturer's Safety Data Sheet.



**INSPECT THE EQUIPMENT DAILY** Inspect the equipment for worn or broken parts daily. Do not operate the equipment if you are uncertain about its condition.



**KEEP EQUIPMENT GUARDS IN PLACE** Do not operate the equipment if the safety devices have been removed.



**FIRE AND EXPLOSION HAZARD** Improper equipment grounding, poor ventilation, open flame, or sparks can cause a hazardous condition resulting in fire or explosion and serious injury.



**PROJECTILE HAZARD** You may be injured by venting liquids that are released under pressure; or flying debris.



**PINCH POINT HAZARD** Moving parts can crush and cut. Pinch points are any areas where there are moving parts.



**NOISE HAZARD** You may be injured by loud noises from support equipment (generators, compressors, transfer pumps). Hearing protection should be used.



**STATIC CHARGE** Fluid may develop a static charge that must be dissipated through proper grounding of the equipment, objects to be sprayed, and all other electrically conductive objects in the dispensing area. Improper grounding or sparks can cause a hazardous conditions and result in fire, explosion, electric shock, and other serious injury.



**ELECTRICAL SHOCK HAZARD** Disconnect all power sources before accessing any electrical connections in the Control Module, Fluid Modules, or Hoses. Equipment must be serviced by trained personnel only.



**TOXIC FLUID & FUMES** Hazardous fluid or toxic fumes can cause serious injury or death if splashed in the eyes or on the skin, inhaled, injected, or swallowed. LEARN and KNOW the specific hazards or the fluids you are using.



**MEDICAL ALERT** Any injury caused by high-pressure liquid can be serious. If you are injured or even suspect an injury:

- Go to an emergency room immediately.
- Tell the doctor you suspect an injection injury.
- Show the doctor this medical information or the medical alert card provided with your spray equipment.
- Tell the doctor what kind of fluid you were spraying or dispensing.
- Refer to the Material Safety Data Sheet for specific information.







**GET IMMEDIATE MEDICAL ATTENTION** To prevent contact with the fluid, please note the following:





- Never point the gun/valve at anyone or any part of the body.
- Never put hand or fingers over the spray tip.
- Never attempt to stop or deflect fluid leaks with your hand, body, glove or rag.
- Always have the tip guard on the spray gun before spraying.
- Always ensure that the gun trigger safety operates before spraying.
- Always lock the gun trigger safety when you stop spraying.

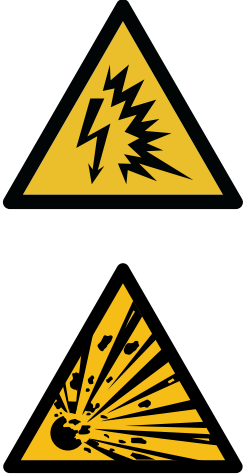



**PROP 65 WARNING:** This product contains chemicals known to the State of California to cause cancer and birth defects or other reproductive harm.





<p><b>AREAS</b> Indicates possible hazard occurrences.</p>	<p><b>HAZARDS</b> Indicates possible hazards.</p>	<p><b>SAFEGUARDS</b> Prevention of possible hazards.</p>
<p><b>Spray Areas</b></p>  	<p><b>Fire Hazards</b></p> <p>Improper or unsatisfactory operation and maintenance procedures will cause a fire hazard.</p> <p>If the safety interlocks are disabled during operation, protection against accidental arcing is shut off and can cause a fire or explosion.</p> <p>Frequent Power Supply or Controller shutdown identifies a problem in the system. If this occurs, a correction will be necessary.</p>	<p>Fire extinguishing equipment must be present in the spray area. Periodically run a test to make sure the equipment stays usable.</p> <p>Spray areas must be kept clean to prevent the buildup of combustible residues.</p> <p>Do not smoke in the spray area.</p> <p>The high voltage supplied to the atomizer must be turned off before the equipment is cleaned, flushed or maintained.</p> <p>Spray booth ventilation must be maintained at the rates set by NFPA-33, OSHA, and country, local, and municipal codes.</p> <p>The area must be ventilated if flammable or combustible solvents will be used to clean the equipment.</p> <p>Prevent electrostatic arcing. Spark-safe work distance must be maintained between the parts to get coated and the applicator. A span of 1 inch for every 10KV of output voltage is necessary.</p> <p>Do an equipment test only in areas free of combustible material. The test may necessitate the high voltage to be on, but only as instructed.</p> <p>Non-factory replacement parts or unauthorized equipment modifications can cause a fire or injury. The key switch bypass is used only during setup operations.</p> <p>Do no production work with disabled safety interlocks.</p> <p>The foam procedure and equipment must be set up and operated in accordance with NFPA-33, NEC, OSHA, local, municipal, country, and European Health and Safety Norms.</p>

<p><b>AREAS</b> Indicates possible hazard occurrences.</p>	<p><b>HAZARDS</b> Indicates possible hazards.</p>	<p><b>SAFEGUARDS</b> Prevention of possible hazards.</p>
<p><b>Spray Areas</b></p> 	<p><b>Explosion Hazard</b></p> <p>Improper or unsatisfactory operation and maintenance procedures will cause a fire hazard.</p> <p>If the safety interlocks are disabled during operation, protection against accidental arcing is shut off and can cause a fire or explosion.</p> <p>Frequent Power Supply or Controller shutdown identifies a problem in the system. If this occurs, a correction will be necessary.</p>	<p>Prevent electrostatic arcing. Spark-safe work distance must be maintained between the applicator and the parts to get coated. A span of 1 inch for every 10KV of output voltage is necessary.</p> <p>Unless specifically approved for use in hazardous locations, put all electrical equipment outside Class I or II, Division 1 or 2 hazardous areas in accordance with NFPA-33.</p> <p>If equipped, the current overload sensitivity must be set as described in the related section of the equipment manual. Protection against accidental arcing that can cause a fire or explosion is off if the current overload sensitivity is incorrectly set.</p> <p>Frequent power supply shutdown indicates a problem in the system which requires correction.</p> <p>Always turn off the control panel power before the system is flushed, cleaned, or servicing the spray system equipment. Before the high voltage is turned on, ensure no objects are within the spark-safe work distance.</p> <p>The control panel is to interlock with the ventilation system and conveyor in accordance with NFPA-33, EN 50176.</p> <p>Fire extinguishing equipment must be present in the spray area. Periodically run a test to make sure the equipment stays usable. Do an equipment test only in areas free of combustible material.</p>
<p><b>General Use and Maintenance</b></p> 	<p>Improper or unsatisfactory operation and maintenance procedures will cause a fire hazard.</p> <p>Personnel must be correctly trained in the operation and maintenance of this equipment.</p>	<p>Train all personnel in accordance with the requirements of NFPA-33, EN 60079-0.</p> <p>Personnel must read and understand these instructions and safety precautions before operating this equipment.</p> <p>Obey appropriate local, municipal, state, and national codes governing ventilation, fire protection, operation maintenance, and housekeeping.</p> <p>Reference OSHA, NFPA-33, EN Norms, and your insurance company requirements.</p>

<p><b>AREAS</b> Indicates possible hazard occurrences.</p>	<p><b>HAZARDS</b> Indicates possible hazards.</p>	<p><b>SAFEGUARDS</b> Prevention of possible hazards.</p>
<p><b>Spray Area High Voltage Equipment</b></p>    	<p><b>Electrical Discharge</b></p> <p>This equipment contains a high-voltage device that can cause an electrostatic induction on ungrounded objects. This electrical charge is capable of igniting coating materials.</p> <p>Insufficient ground will cause a spark hazard. A spark can cause the ignition of many coating materials and cause a fire or explosion.</p>	<p>Operators in the spray area and the parts to be sprayed must be sufficiently grounded.</p> <p>The parts that get sprayed must be held on conveyors or hangers that are correctly grounded. The resistance between the parts and the earth-ground must not exceed 1 MΩ. Refer to: NFPA-33.</p> <p>Ground all operators before the equipment is operated. They cannot wear rubber-soled insulated shoes. Wear ground straps on wrists or legs for sufficient ground contact.</p> <p>Operators must not wear or carry ungrounded metal objects.</p> <p>Operators must make complete contact with the applicator handle when using an electrostatic gun. Use conductive gloves or gloves with the palm section cut out.</p> <p>Operators must not wear grounded footwear.</p> <p><b>NOTE: REFER TO NFPA-33 OR SPECIFIC COUNTRY SAFETY CODES FOR GUIDANCE TO CORRECTLY GROUND THE OPERATOR.</b></p> <p>Except for objects needed for the high-voltage process, all electrically conductive objects in the spray area are to be grounded. Supply a grounded conductive floor in the spray area.</p> <p>Always turn off the power supply before the system is flushed, cleaned or when the spray system equipment is serviced.</p> <p>Unless specifically approved for use in hazardous locations, put all electrical equipment outside Class I or II, Division 1 or 2 hazardous areas in accordance with NFPA-33.</p>



<p><b>AREAS</b> Indicates possible hazard occurrences.</p>	<p><b>HAZARDS</b> Indicates possible hazards.</p>	<p><b>SAFEGUARDS</b> Prevention of possible hazards.</p>
<p><b>Spray Areas</b></p> 	<p><b>Toxic Fluid or Fumes</b></p> <p>Toxic fluids or fumes can cause serious injury or death if splashed in the eyes or on the skin, inhaled, or swallowed.</p>	<p>Read the Safety Data Sheet (SDS) for instructions on how to correctly handle specific hazards of the fluids to be used, including the effects of long-term exposure.</p> <p>During the spray, clean, or servicing of equipment, or when in the work area, keep the work area fully ventilated.</p> <p>Always wear personal protective equipment (PPE) when in the work area or during equipment operation. Refer to the <b>Personal Protective Equipment</b> warnings in this manual.</p> <p>Store hazardous fluid in approved containers, and refer to local, municipal, state, and national codes governing disposal of hazardous fluids.</p>
<p><b>Spray Area and Equipment Use</b></p> 	<p>High pressure fluid sprayed from the gun, hose fittings, or ruptured/damaged components can pierce the skin.</p> <p>While this injury can appear as cut skin, this is a serious injury that can result in amputation of the affected area.</p>	<p>Do not point or operate the spray gun at any body part of a person.</p> <p>Do not put your hand or fingers over the gun fluid nozzle or fittings in the hose or Proportioner.</p> <p>Do not try to stop or deflect leaks with your hand, glove, body, or shop rag.</p> <p>Do not “blow back” fluid, as the equipment is not an air spray system.</p> <p>Relieve pressure in the supply hoses, Proportioner, and QuickHeat™ hose before the equipment is inspected, cleaned, or serviced.</p> <p>Use the lowest possible pressure to purge, recirculate, or troubleshoot the equipment.</p> <p>Examine the hoses, couplings, and fittings every day.</p> <p>Service or immediately replace parts that leak, are worn, or damaged. High pressure hose sections cannot be recoupled or serviced, and must be replaced.</p>

<p><b>AREAS</b> Indicates possible hazard occurrences.</p>	<p><b>HAZARDS</b> Indicates possible hazards.</p>	<p><b>SAFEGUARDS</b> Prevention of possible hazards.</p>
<p><b>Equipment and Fluids</b></p> 	<p><b>Skin and Clothing Burns</b></p> <p>Equipment surfaces and fluids can become very hot during operation.</p>	<p>Do not touch hot fluid or equipment during operation.</p> <p>Do not let clothing touch the equipment during operation or immediately after the equipment is stopped.</p> <p>Let the equipment fully cool before component examination or servicing.</p>
<p><b>Pressurized Aluminum Parts</b></p>    	<p>Certain solvents and chemicals can cause equipment damage and serious personal injury.</p>	<p>Do not use 1,1,1-trichloroethane, methylene chloride, or other halogenated hydrocarbon solvents or fluids that contain such solvents.</p> <p>These solvents can cause a serious chemical reaction and equipment rupture that results in equipment and property damage, serious bodily injury, or death.</p>

**⚠ CAUTION**

Do not operate the IS30 before this section is read.

**ADDITIONAL SAFETY INFORMATION**

The IntelliSpray has an emergency stop (E-Stop) pushbutton on the main operator panel. During an emergency, all operations for the IntelliSpray will halt when the E-Stop is engaged. The operator must disengage the E-Stop and reset the system to recover from this state.

Observe all local or municipal safety measures and wear approved protective equipment when servicing this equipment. Clean all spilled chemicals and materials and work in a clean and organized environment to prevent personal injury and equipment damage.

**⚠ DANGER**

To prevent injury or electrocution, do not contact, disconnect, or manipulate electrical connections or devices while the system is under power. The main disconnect on the right side of the control module can be locked out, and proper Lockout-Tagout (LOTO) procedures must be used for electrical work internal to the control module.

If this is not possible for the purpose of diagnosis and troubleshooting during working conditions, then only qualified electrical personnel are to perform the work.

**⚠ WARNING**

To prevent possible chemical spillage when personnel are not on site, air and fluid supplies for the equipment must be disabled when the equipment is idled for an extended period of time such as end-of-day shutdown, etc.

**NOTICE**

During the initial commission of the equipment, and at periodic times throughout the life of the equipment, all fluid fittings must be visually inspected for leaks.

Periodically, all pieces of this equipment must be visually inspected for signs of obvious degradation due to chemicals or other conditions present in the environment where the equipment is installed.

**SAFETY**

Local regulations may require fire suppression equipment to be installed where the equipment is operated.

This page intentionally left blank.

Product Description / Object of Declaration:	IS 30, IS 40
This Product is designed for use with:	Non Flammable Materials Only
Suitable for use in hazardous area:	
Protection Level:	Not Applicable
Notified body details and role:	TUV SUD America Inc 141 14th St NW New Brighton MN 55112 USA
	Low Voltage and EMC Assessment
This Declaration of Conformity / Incorporation is issued under the sole responsibility of the manufacturer:	Carlisle Fluid Technologies Inc 7166 4th St. N. Oakdale, MN 55128 USA

**EU Declaration of Conformity**



**This Declaration of Conformity / Incorporation is issued under the sole responsibility of the manufacturer:**

EMC Directive 2014/30/EU  
 Low Voltage Directive 2014/35/EU  
 RoHS Directive 2011/65/EU  
 by complying with the following statutory documents and harmonised standards:  
 EN 61000-6-2:2005/AC:2005 Electromagnetic compatibility (EMC) - Part 6-2: Generic standards - Immunity for industrial environments  
 EN 61000-6-4:2007/A1:2011 Electromagnetic compatibility (EMC) - Part 6-4: Generic standards - Emission standard for industrial environments.  
 EN 61000-3-11:2000 (>16A) Electromagnetic compatibility (EMC) - Part 3-11: Limits - Limitation of voltage changes, voltage fluctuations and flicker in public low-voltage supply systems  
 EN 61000-3-12:2011 (>16A) Electromagnetic compatibility (EMC) - Part 3-12: Limits - Limits for harmonic currents produced by equipment connected to public low-voltage systems with input current.  
 EN 63000: 2018 Technical documentation for the assessment according to REACH  
 EN 60204-1:2018 Safety of Machinery. Electrical equipment of machines  
 FCC 47 CFR Part 15-Radio Frequency Devices, Subpart B – Unintentional Radiators  
 ICES-001, Issue 5:2020 Class A Industrial, Scientific, and Medical (ISM) Equipment

Providing all conditions of safe use / installation stated within the product manuals have been complied with and also installed in accordance with any applicable local codes of practice.

Signed for and on behalf of Carlisle Fluid Technologies:		F. A. Sutter	Executive President: Engineering and Operations, Scottsdale, AZ, 85254. USA
Document Part No. EN			

	Ref. Certif. No.
	US/9719/ITS

**IEC SYSTEM FOR MUTUAL RECOGNITION OF TEST CERTIFICATES FOR ELECTRICAL EQUIPMENT (IECEE) CB SCHEME**

**CB TEST CERTIFICATE**

Product	IntelliSpray Spray Foam Proportioner
Name and address of the applicant	Carlisle Fluid Technologies, Inc. 16430 N. Scottsdale Rd. Suite 450 Scottsdale, AZ, 85254 United States of America
Name and address of the manufacturer	Motion Tech Automation LLC 7166 4th St. N. Oakdale, MN, 55128 United States of America
Name and address of the factory <i>Note: When more than one factory, please report on page 2</i>	Motion Tech Automation LLC 7166 4th St. N. Oakdale, MN, 55128 United States of America <input type="checkbox"/> Additional information on page 2
Ratings and principal characteristics	IS30: 200-240Vac, 67A, 50/60Hz, 3 Phase IS40: 200-240Vac, 78A, 50/60Hz, 3 Phase
Trademark / Brand (if any)	 CARLISLE FLUID TECHNOLOGIES // IntelliSpray
Customer's Testing Facility (CTF) Stage used	CTF Stage 1
Model / Type Ref.	IS30, IS40
Additional information (if necessary may also be reported on page 2)	<input type="checkbox"/> Additional information on page 2
A sample of the product was tested and found to be in conformity with	IEC 61010-1:2010/AMD1:2016, IEC 61010-2-010:2019, IEC 61010-2-051:2018 <b>Comments:</b> Refer to the Test Report for the Summary of Compliance with National Deviations
As shown in the Test Report Ref. No. which forms part of this Certificate	105047444MIN-001, 105047444MIN-002, 105047444MIN-003

This CB Test Certificate is issued by the National Certification Body

Intertek Testing Services NA, Inc. 545 E. Algonquin Road Arlington Heights IL 60005 United States of America	 Signature: John Quigley
Date: 2022-12-14	

## IMPORTANT ISOCYANATE INFORMATION

### GENERAL HANDLING GUIDELINES

Isocyanates (ISO) are catalysts used in two-component materials.

Fluids with isocyanates that are sprayed or dispensed create potentially harmful mists, vapors, and atomized particulates. Workers exposed to isocyanates can develop a range of short and long-term health problems.

**Read and understand the fluid manufacturer's warnings and Safety Data Sheet (SDS) for specific isocyanate hazards and precautions.**

- Use of isocyanates involves potentially hazardous procedures. Do not spray with this equipment unless you are trained, qualified, and have read and understood the information in this manual and the fluid manufacturer's application instructions and SDS.
- Using incorrectly maintained or adjusted equipment may result in unsatisfactory cured material which can cause off-gas and create offensive odors. Refer to the instructions in the manual to correctly maintain and operate the equipment.
- To prevent inhalation of isocyanate mists, vapors, and atomized particulates, everyone in the work area must wear applicable respiratory protection. Always wear a correctly fitted respirator that includes a supplied air respirator. Refer to the fluid manufacturer's SDS instructions for correct work area airflow.
- Avoid all skin contact with isocyanates. Everyone in the work area must wear chemically impermeable gloves, protective clothing, and foot covers recommended by the fluid manufacturer and local regulatory authorities. Follow all fluid manufacturer recommendations include the discarding of contaminated clothing. Do not eat or drink after the equipment is used until the hands and face have been washed.
- Hazards from exposure to isocyanates continue after spray use. Anyone without correct personal protective equipment must stay out of the work area during and after the application and for the time period specified by the fluid manufacturer. This time period is usually a minimum of 24 hours.
- Warn others who may enter the work area of hazards from exposure to isocyanates. Follow the recommendations of the fluid manufacturer and local regulatory authority.
- It is recommended to post a sign outside the work as the one shown below:

<b>⚠ WARNING</b>	
	<b>TOXIC FUME HAZARD</b>
<b>DO NOT ENTER DURING SPRAY FOAM APPLICATION OR FOR__HOURS AFTER APPLICATION IS COMPLETE</b>	
<b>DO NOT ENTER UNTIL AFTER:</b>	
<b>DATE: _____ TIME: _____</b>	

## MATERIAL SELF IGNITION

Some materials may become self-igniting if applied too thick. Read material manufacturer's warnings and Safety Data Sheet.

## KEEP COMPONENTS A & B SEPARATE

Prevent cross-contamination of A and B materials. Cured material in fluid lines and passages can cause serious personal injury or equipment damage.

Never interchange the wetted parts of components A and B.

Never use solvent on one side that is contaminated with fluid from the other side.

## EXPOSURE TO MOISTURE

ISO will start to cure and form small, hard, abrasive crystals when exposed to moisture and humidity.

These crystals become suspended in the fluid and can cause equipment damage. Over time, a film will form on the surface and the ISO will get thicker with increased viscosity.

## NOTICE

ISO that has started to cure will reduce the life and performance of all wetted parts.

A sealed container with a desiccant dryer in the vent, or a nitrogen atmosphere in the empty head space of the container must be used.

ISO must not be stored in an open container.

The ISO pump reservoir must be kept filled with applicable lubricant. The lubricant creates a barrier between the ISO and the atmosphere.

Only ISO compatible moisture-proof hoses must be used.

Reclaimed solvents, which may contain moisture, must not be used.

Solvent containers must be closed when not in use.

Assemble threaded parts only with the correct lubricant.

## FOAM RESINS W/245 FA BLOWING AGENTS

Some materials may become self-igniting if applied too thick. Read material manufacturer's warnings and Safety Data Sheet (SDS).

## CHANGING MATERIALS

Prevent equipment damage and downtime during material changes and flushes for service or storage.

- Flush equipment multiple times to make sure it is fully clean.
- The fluid strainers must be cleaned after all flushes. Speak with the material manufacturer for information on chemical compatibility.
- When there is a change between epoxies, urethanes, or polyureas, all wetted parts must be disassembled and cleaned, and the hoses changed.

## ELECTRICAL GROUND

Examine the local electrical code and Proportioner manual for instructions on how to ground the equipment.

Ground the spray gun through a connection to a Carlisle Fluid Technologies approved grounded fluid supply hose.



## INTELLISPRAY SYSTEM OVERVIEW

The Carlisle Fluid Technologies IntelliSpray™ IS30 Spray Polyurethane Foam (SPF) system consists of a Proportioner, QuickHeat™ Hose, and ST1™ Spray Gun. The IntelliSpray system is designed for ease of use, increased productivity, “best in class” process control, easy service, and real-time ratio control.

QuickHeat hoses have approximately double the heat power compared to most other SPF hoses. QuickHeat hoses directly heat the fluid from inside the hose, for fast and efficient fluid heating, even in cold climate conditions. QuickHeat hoses have embedded temperature and pressure sensors, independent A and B heated hoses and up to 4 separate heating zones to improve temperature control.

QuickHeat hoses supply sensor power and signal communication without cables or connectors, eliminate failure points, and improve reliability. QuickHeat hoses include a snag-proof, abrasion-resistant outer hose wrap sealed with industrial-grade Hook & Loop material for individual A or B-side hose replacement.

The ST1 gun has improved ergonomics, lower weight, ease of service, and a wide range of output and pattern control with configurable chamber and tip combinations.

The system will also work with high-pressure spray foam guns with compatible hose manifolds.

Refer to the QuickHeat Hose Manual and ST1 Gun Manual for more information.

### ⚠ WARNING

For professional use only. Not for use in explosive environments or atmospheres. Equipment must not be installed in outdoor locations.



Carlisle IntelliSpray™ Spray Foam Proportioners are high-performance devices that deliver Isocyanate (A) and Polyol Resin (B) fluids to a spray gun via Carlisle Fluid Technologies QuickHeat™ hoses.

The Proportioner monitors and controls A to B fluid output to a 1:1 ratio and is capable of high pressures, temperatures, and flow rates. Efficient, high-power preheaters along with independent A and B multi-zone internal hose heating ensures user settings control fluid temperatures.

Pressure and temperature sensing near the spray gun provide consistent performance regardless of hose length, fluid viscosities, elevation changes, or environmental conditions.

The Control Module has components used in high-duty-cycle rugged industrial environments. The heart of the control module is an industrial-grade controller that senses over 30 inputs (flow, temperature, pressure) and drives over ten outputs up to 1000 times per second.

The controller stores job data, recipes, historical performance information, user information, and alarm histories. The software can be updated remotely or with a USB memory stick. A 15.6" (IS40) or 10.1" (IS30) high-strength touch-screen allows the user to monitor and control the Proportioner and hoses.

The Control Module provides "Out Of Box" remote system monitoring and control without additional hardware or software. The Control Module includes power management, circuit protection, motor control, heater power, remote connectivity, internal I/O, and electrical safety systems. The Control Module includes a thermostatically controlled cooling fan that draws in outside air through a user-cleanable filter.

Diagnostics and repair are made simple via clear messages and monitoring screens, while Component replacement is fast and simple.

IntelliSpray Proportioners use independent Fluid Modules that contain temperature and pressure sensors, fluid filters, shutoff and recirculation valves, fluid preheaters, servo motors, flow meters, pressure gauges, and direct-drive external gear pumps specifically designed to handle spray foam materials.

This independent, compact, modular design approach allows the system to deliver material "on-ratio" whenever the gun is triggered.

The Fluid Module can be partially or fully extracted from the Proportioner frame, for ease of service. All common service components can be accessed from the front of the module and replaced on-site using simple hand tools in minutes.

IntelliSpray Proportioners are specifically designed to use Carlisle Fluid Technologies QuickHeat™ hoses. These unique hoses contain high-power internal electric



heating cables, ensuring that all of the heating energy is transmitted to the fluid. QuickHeat hoses are provided in 50, 100, 150 and 200ft lengths (main hose lengths). The Smart Ends (connected as extensions to the main hose sections) are provided in 20, 25, and 40ft lengths, with the 25ft version having increased flexibility. Connected to the end of the Smart End is an unheated, insulated whip. This comes in 3, 4, 6, and 10ft lengths, with the 4ft version having increased flexibility.

Each length of heated hose begins with a fluid manifold or "modem" that may contain temperature and/or pressure sensors, heater cable connectors, and electronics used to send information over the hose to the Control Module. With this approach, no sensor power or communication cables are required, which are a common source of hose failures in other systems. This approach allows the IS30 and IS40 to receive more information from multiple sensing locations at each hose junction. It also allows the projection of information down the hose to remote monitoring and control devices. More information about QuickHeat hoses is contained in the QuickHeat Hose Manual.

Finally, IntelliSpray Control and Fluid Modules are mounted in a high-strength tubular steel frame that protects the modules from damage and provides multiple horizontal and vertical mounting points.

## IS30 SPECIFICATIONS

The IS30 Proportioner is roughly 32" wide, 68" tall, and 27" deep. Eight separate floor mounting holes are located at the base of the unit, and a slotted wall mounting bracket is provided along the back of the unit.

The IS30 must be securely attached to the floor and wall in any mobile or seismic installation. For more information, refer to the "INSTALLATION" chapter.

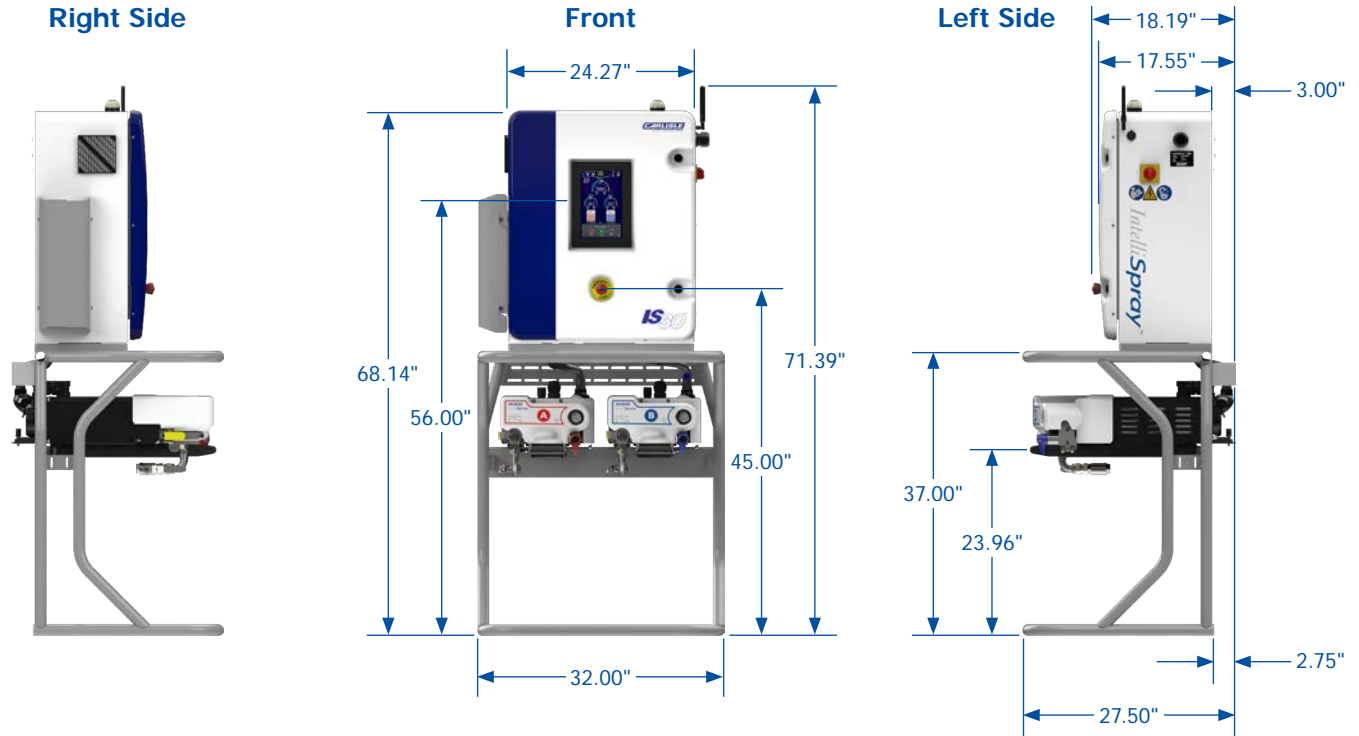

The table to the right shows other physical, operating, and electrical specifications. The electrical specifications include the maximum hose length that can be powered by the IS30 and the motor current at stall load. Typical current draw in most applications is under 60 Amps (3 phase). Still, installers and owners should consult with their authorized IntelliSpray Service Provider to determine the minimum size circuit for specific installations. Generator size is left to the rig builder to determine based on these specifications and other electrical loads in the rig.

Physical, Environmental, and Electrical Specifications	
Weight	415 lbs (188 kg)
Maximum Fluid Pressure	2500 psi (172 Bar)
Operating Temperature	32/120° F (0-50° C)
Humidity	0-85% Non Condensing
Input Voltage	200-240V or 380-415V
Frequency	50/60 Hz
Phase	3 or 3+N
Full Load Amps	67 A or 44 A
Maximum Disconnect	80 A
SCCR	5 kA

This page intentionally left blank.

## IS30 OVERVIEW

The IS30 is a modular system composed of a Control Module, A and B Fluid Modules, a high-strength tubular frame, and software. The frame includes integral floor and wall mounting brackets. The A and B Fluid Modules are identical except for motor size, front cover labels, recirculation valve colors, and outlet fluid fittings (JIC 5 for A, hose, JIC 6 for B hose). The figure below and the following sections will help the user become familiarized with the IS30 Proportioner.

### IS30

1. Status Light
2. Cover Latches (x2)
3. Cellular Antenna
4. Power Cord Inlet
5. On/Off Switch
6. Control Module
7. HMI
8. Emergency Stop Button
9. B Fluid Module
10. Floor Mounting Brackets
11. A Fluid Module
12. Wall Mounting Bracket (not shown)
13. Frame
14. Hose Power
15. Hose Communication
16. QuickHeat™ Hose Connection Cover



This page intentionally left blank.

## FLUID MODULE

The IS30 Fluid Modules independently filter, heat, pressurize, and deliver A and B materials to the QuickHeat hose and recirculation lines.

Material is supplied to the Fluid Modules from drums, totes, or other fluid containers. To assure proper operation the IS30 requires the fluid to be provided at a pressure that avoids cavitation. Depending on the viscosity and flow rate of the fluid, the inlet pressure should be at least 25 psi at all times.

To avoid cavitation supply pumps should be sized to provide at least 2 GPM continuous flow at an inlet fluid

pressure of 100 psi. The IS30 will issue an error message and stop if inlet fluid pressure is either too low or too high.

The IS30 Fluid Modules are highly integrated to reduce size, complexity, and number of fluid fittings. With their modular design approach they can be easily serviced while in the proportioner or completely removed and reinstalled within minutes. With the exception of minor differences, the A and B fluid modules are identical.

The following images show the locations of primary components and features in each Fluid Module.

### MODULE DESCRIPTION—GENERAL

1. Motor Encoder Connector
2. Server Motor
3. Front Cover
4. Pressure Gauge
5. Recirculation Valve
6. Front Handle
7. Retainer Screw
8. Inlet Filter Cap
9. Inlet Hose Fitting
10. Filter Module Outlet Valve
11. Release Pin (not shown)
12. Motor Power Connector
13. Communicator Connector
14. Heater and Sensor Power Connector
15. Spray Hose Fitting (not shown)
16. Recirculation Hose Fitting

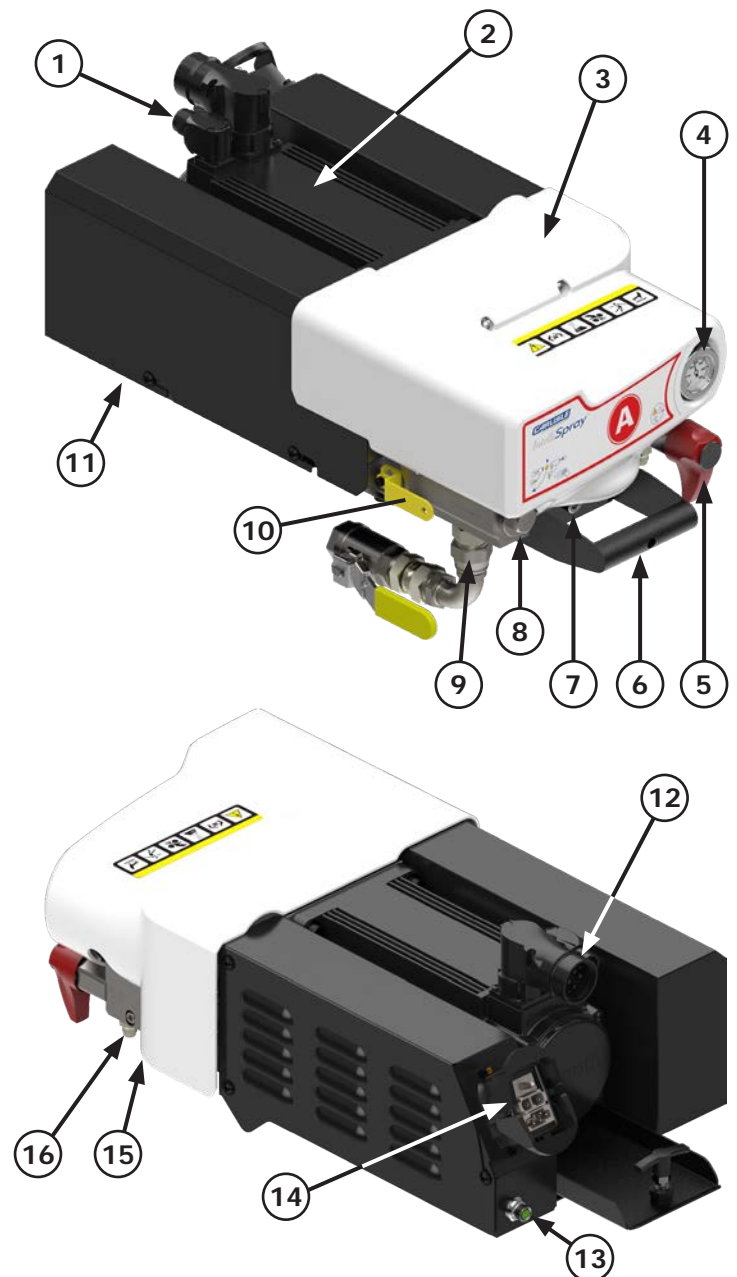



The A and B Fluid Modules have similar controls as described and shown below.

**Filter Valve:** The IS30 has an internal 1/4 turn ball valve that prevents the backflow of material when cleaning or replacing the inlet filter. The inlet filter can be serviced with minimal fluid leakage by closing both the inlet ball valve and the filter valve. See the "SERVICING" chapter for filter service instructions.

**Recirculation Valve:** When the handle is pointed down, it is in the Spray position, and all flow will be through the distribution (spray gun) hoses. When turned 90 degrees counterclockwise (CCW), fluid will also allow flow to the

recirculation line. Note that it does not stop fluid flow to the gun hoses when in recirculation position.

**Analog Pressure Gauge:** This indicates fluid pressure in the high-pressure manifold, including the spray gun hoses.

**Cover Screws:** Remove for cover removal. The cover should be in place when the unit is in use.

**Captive Retainer Screw:** This holds the module to the frame and should always be engaged except when servicing the module.

### MODULE DESCRIPTION—FRONT (A MODULE SHOWN)

1. Cover Screws
2. Pressure Gauge
3. Recirculation Valve
4. Retainer Screw
5. Release Pin
6. Filter Valve

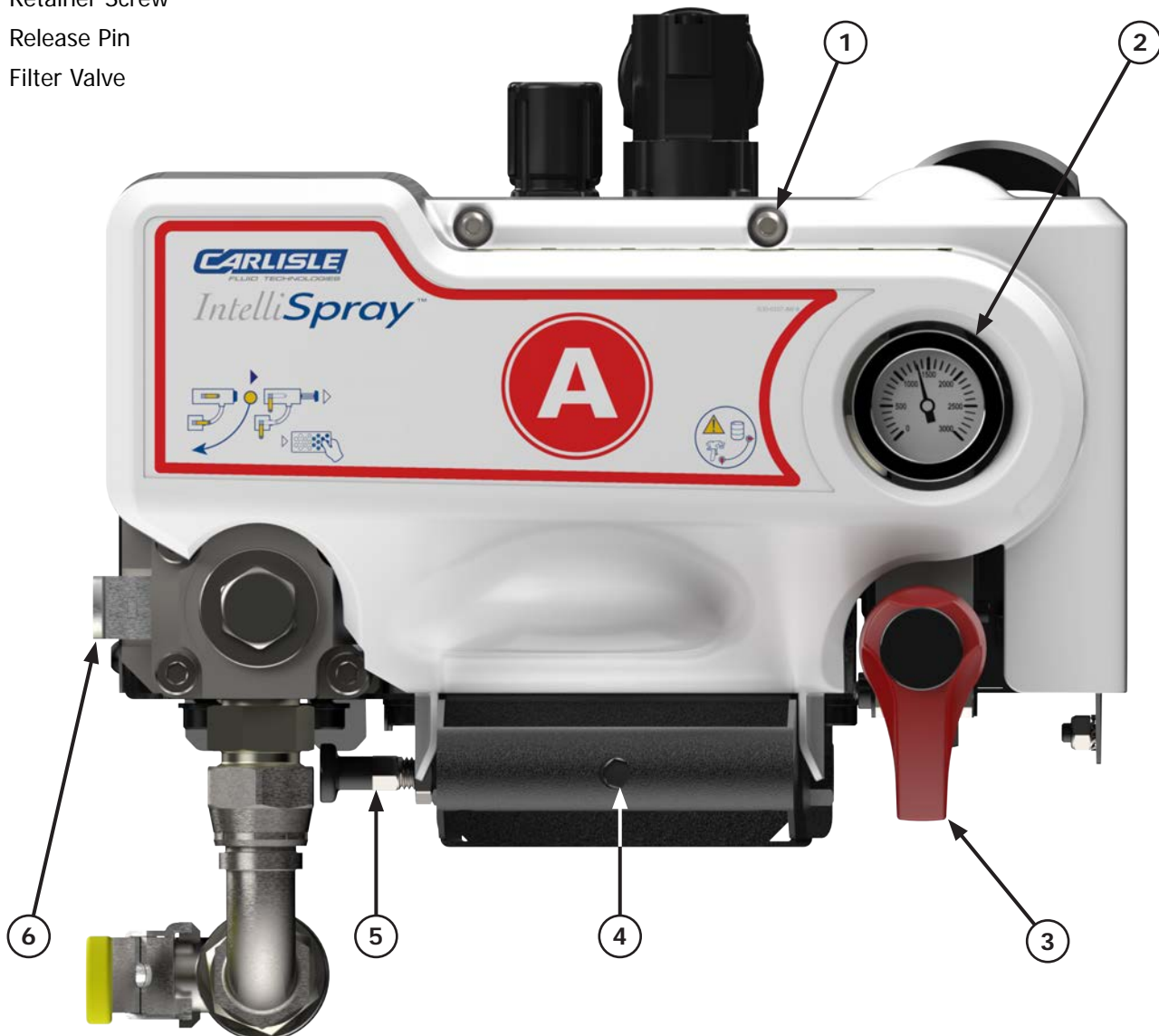



The images below show the IS30 Fluid Module with the covers removed.

The A and B Fluid Modules are identical except for the following:

- The A and B covers have different labels attached to them (A and B).
- The Recirculation valve handles are different colors (red for A, blue for B)

- The outlet JIC fitting sizes are unique for A (JIC 5) and B (JIC 6) to prevent cross-contamination when installing or servicing.
- The spring-loaded locking pin is located on opposite sides for easier access.

### MODULE DESCRIPTION— W/O COVER

1. Fluid Preheater Module (Cover removed)
2. 5000 PSI Pressure Sensor
3. Pump
4. Flow Meter
5. 1000 PSI Pre-Pump Pressure Sensor
6. Pre-Pump Temperature Sensor
7. Inlet Temperature Sensor
8. 1000 PSI Pre & Post Filter Pressure Sensors (not shown)
9. High Pressure Module
10. Check Valve
11. Fluid Module Electronics Module

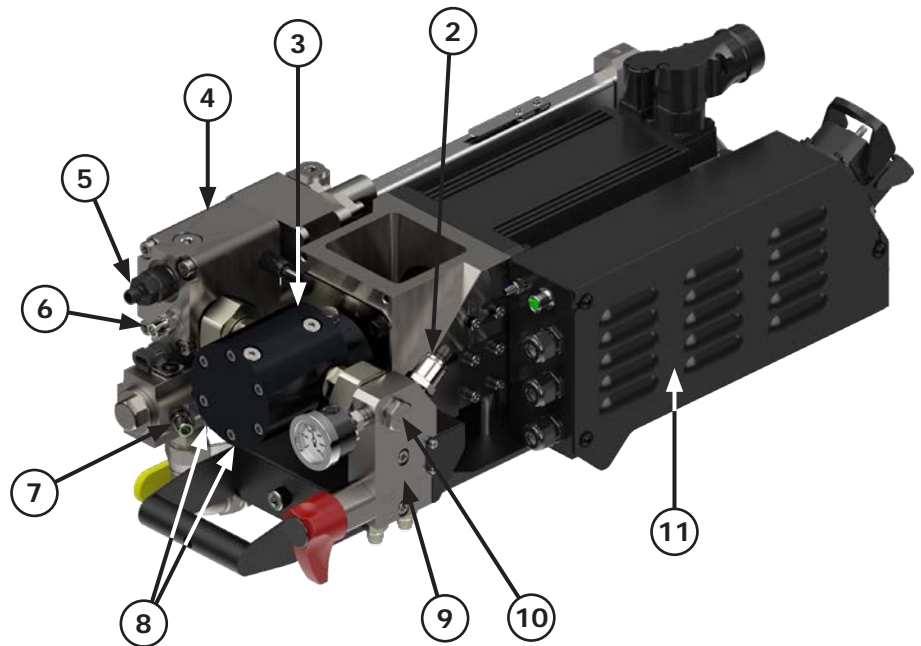
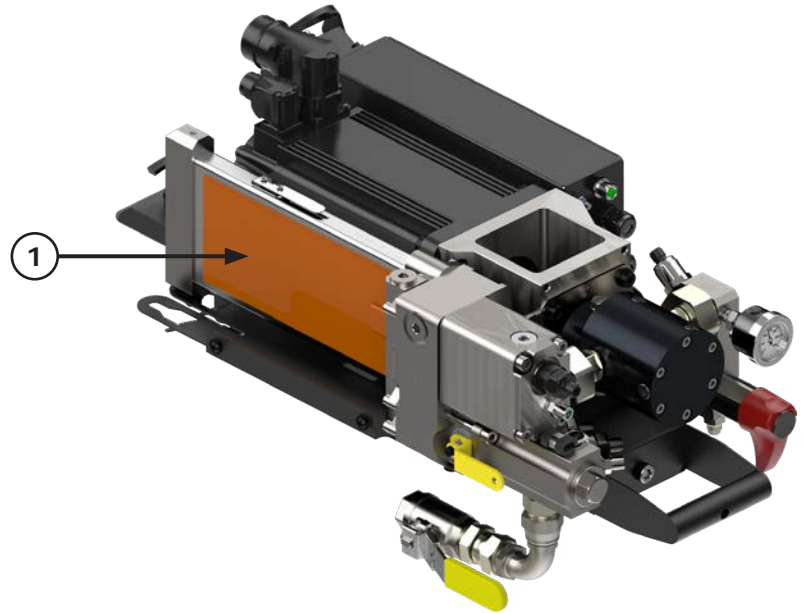

## MODULE ASSEMBLIES-OVERVIEW

The following figure shows the major IS30 Fluid Module components. Additional breakdowns and parts lists are contained in the "MAINTENANCE" chapter.

### MODULE ASSEMBLIES DESCRIPTION

1. Low-Pressure Module
  - 1.1 Preheater
  - 1.2 Flow Meter
  - 1.3 Filter Module
2. Pump Module
  - 2.1 Servo Motor
  - 2.2 Pump
  - 2.3 Motor Mount
3. Preheater Cover
4. Front Cover
5. High-Pressure Module Bracket
6. Electronics Module
7. High-Pressure Module
8. Fluid Module Frame

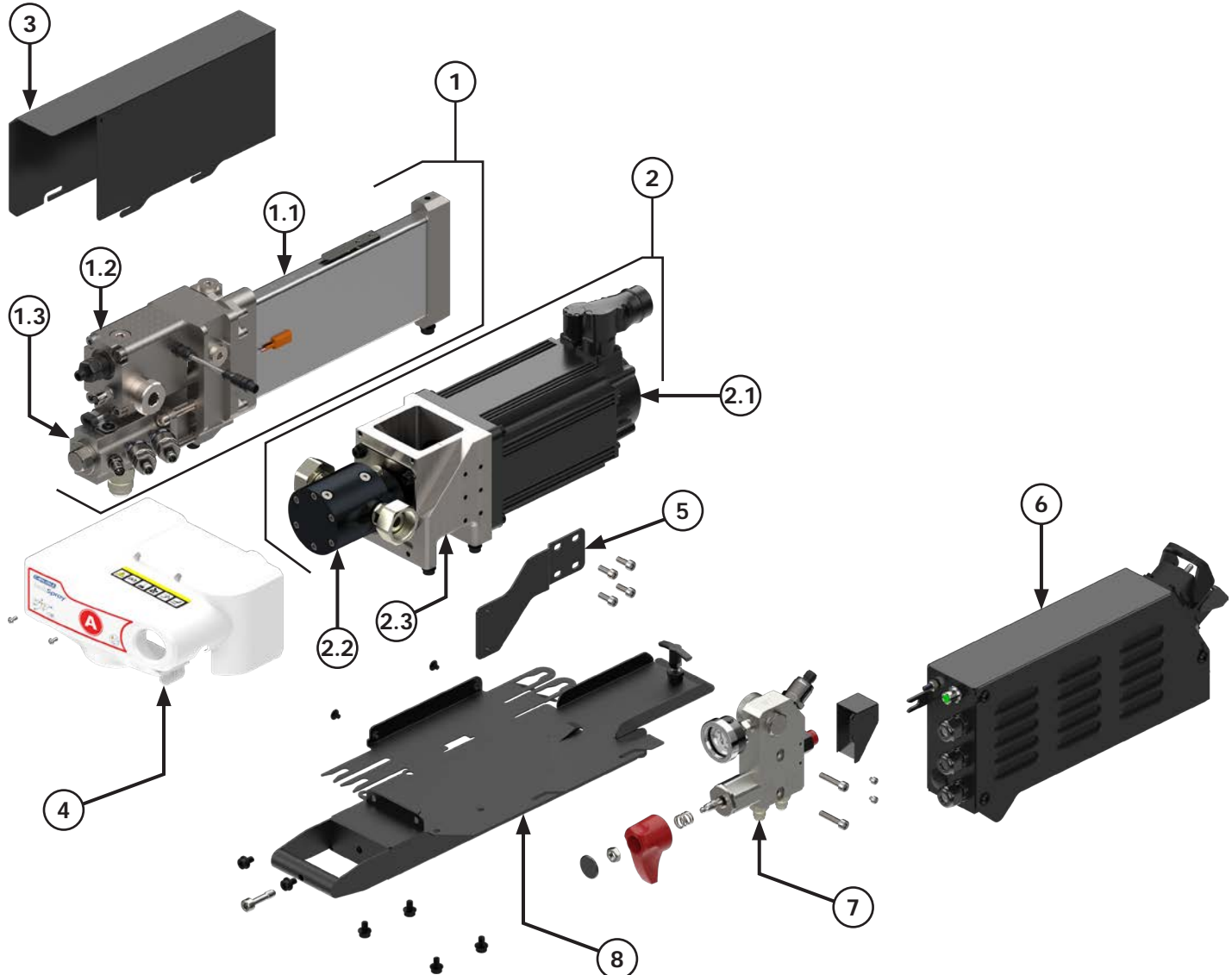

### MODULE FLUID PATHWAYS

The following diagram shows the fluid path and major fluidic elements in the IS30 Fluid Modules. Flow is from left to right, as indicated by the arrows.

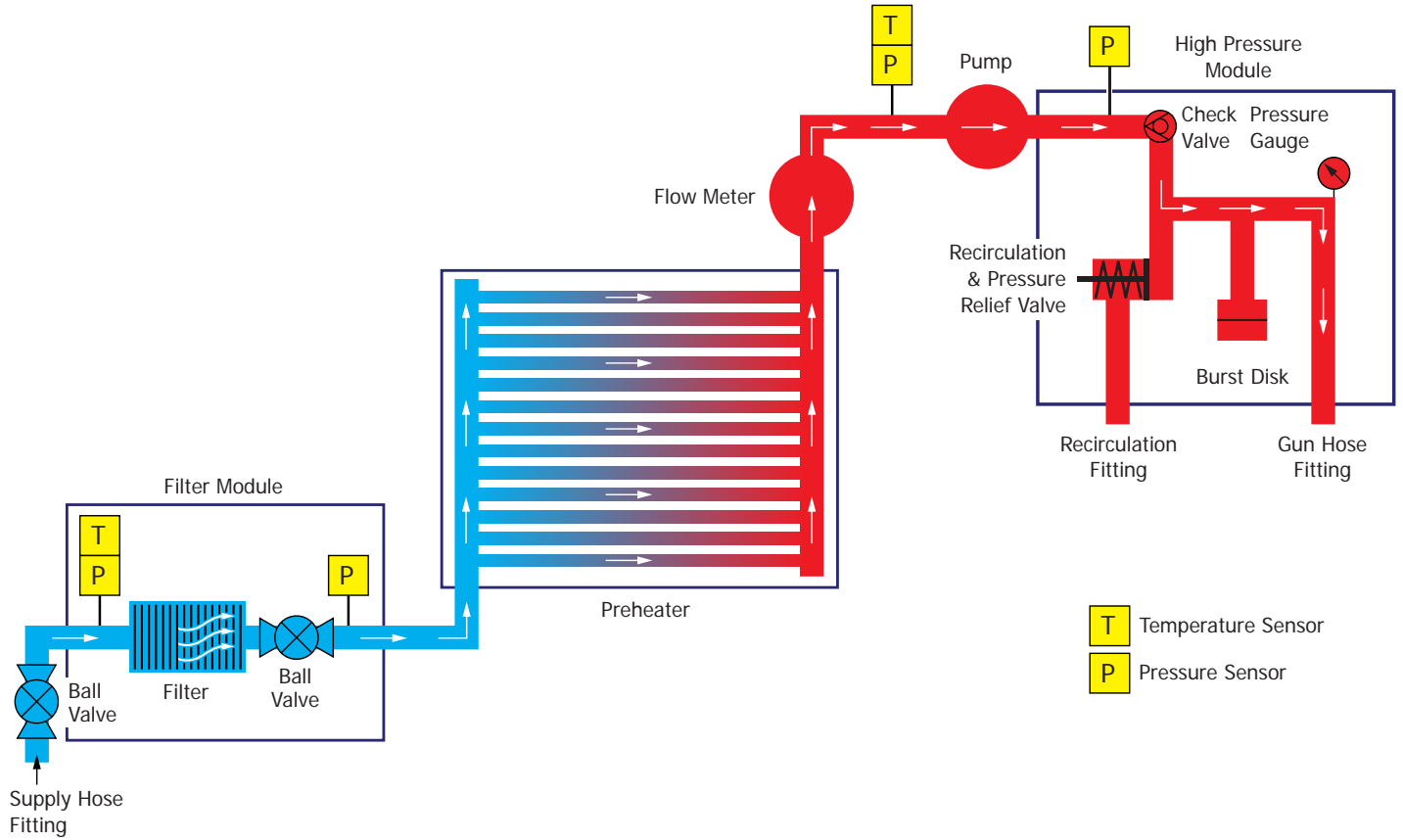

## FILTER MODULE

The primary fluid handling elements of each A and B Fluid Module and their functions are described below and shown in the following pages.

Filter Module: The Filter Module consists of the following components mounted in a machined aluminum manifold.

- **Inlet valves:** An inlet ball valve is provided that can be used to isolate the filter element module. When the valve is in the closed position, the User can service the filter elements with minimal fluid loss.

The Fluid Modules are at a height that allows the User to place a bucket under the filter module to collect any drips during maintenance.

- **Inlet temperature sensor:** The Filter Module contains an inlet temperature sensor that indicates the temperature of incoming material. The inlet temperature for each material is displayed on drum icons on the spray screen.

Warning and Error alarms can be set in the Menus

Screen to prevent the User from working with fluid outside recommended temperature limits.

- **Filter Body:** A 7/8" hex head cap holds the filter body and element in place. This is a straight thread cap that has a sealing O-ring that should be checked and replaced if needed when servicing the filter elements.

Always grease the threads, especially the A-side, to prevent the filter cap threads from locking.

- **Filter Elements:** Each Filter Body holds one 30 mesh filter element that can be easily cleaned or replaced.

- **Pressure Sensors:** The Filter Module has two sensors measuring pressure on each filter element's side. These sensors allow the IS30 to alert the User when the filters need to be cleaned or replaced.

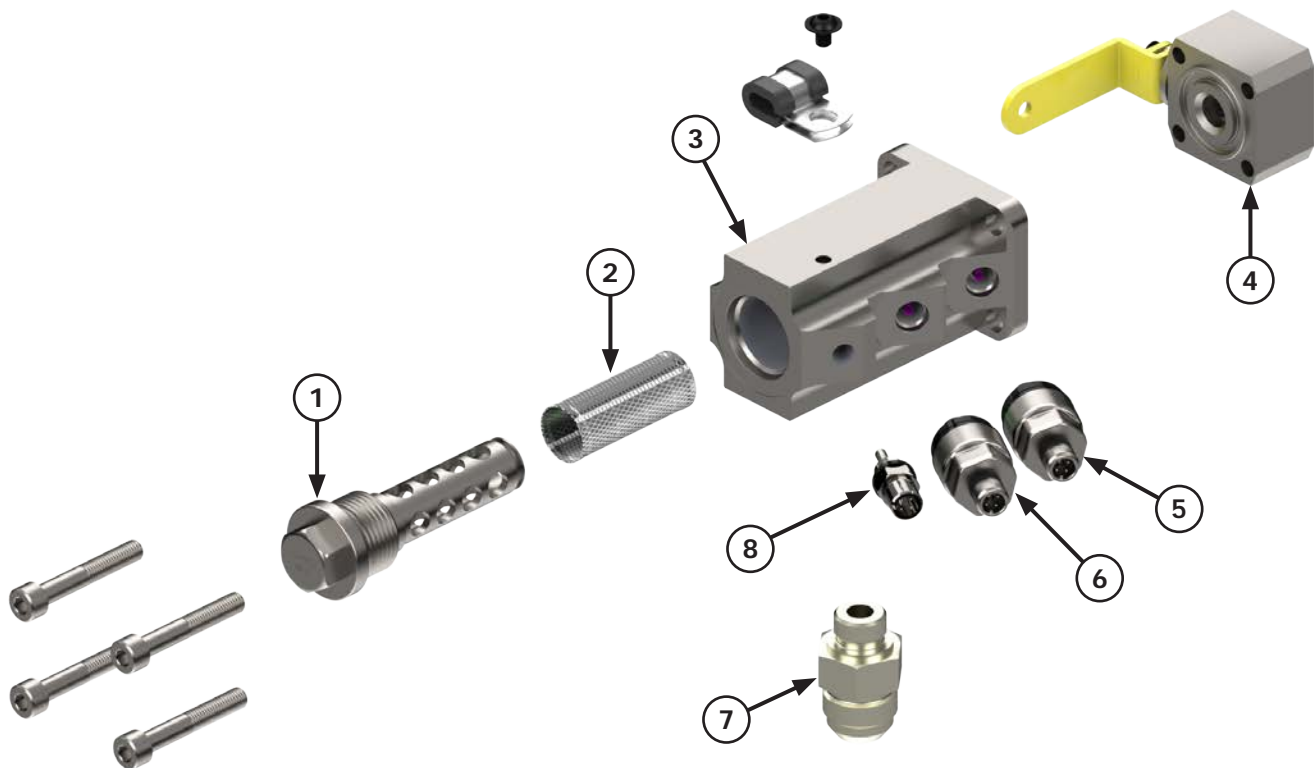

## FILTER MODULE DESCRIPTION

- |                             |                                  |
|-----------------------------|----------------------------------|
| 1. Filter Body              | 5. Filter Outlet Pressure Sensor |
| 2. Filter Element (30 Mesh) | 6. Filter Inlet Pressure Sensor  |
| 3. Filter Manifold          | 7. JIC M12 Inlet Fitting         |
| 4. Filter Isolation Valve   | 8. Inlet Temperature Sensor      |

## LOW-PRESSURE MODULE

**Preheater Module:** The IS30 uses low-mass preheaters to warm the A and B fluids on the low-pressure side of the Fluid Pumps. This allows the preheaters to rapidly respond to variations in incoming fluid temperature, flow rates, or setpoint changes.

Each Preheater has 14 fluid flow channels running down and back through the heat exchanger. An etched foil heater blanket is firmly bonded to the heat exchanger's outside. This approach eliminates direct heater element contact with fluids (as with immersion heaters) and increases heat transfer area to fluids by up to a factor of 4 (compared to other systems). This lets the heater elements operate at lower temperatures than typical immersion heaters, increasing reliability and reducing the risk of material charring.

A temperature sensor is attached to the heat exchanger as part of the fluid temperature control electronics.

A fail-safe replaceable thermal fuse is mounted on each heater assembly to prevent thermal run-aways if all other control systems fail.

These design features allow the preheaters to come to temperature within several minutes of startup, minimizing warmup time.

**Pre-pump Pressure Sensor:** This pressure sensor is used to confirm that the supply (e.g., drum) pump is providing enough pressure to prevent gear pump cavitation.

**Pre-pump Temperature Sensor:** This sensor monitors the temperature of fluid leaving the Preheater and is also used to control fluid temperature when preheating drum material in Exchange mode.

**Flow Meter:** High-precision gear flow meters continuously measure fluid flow to deliver A:B fluid on-ratio.

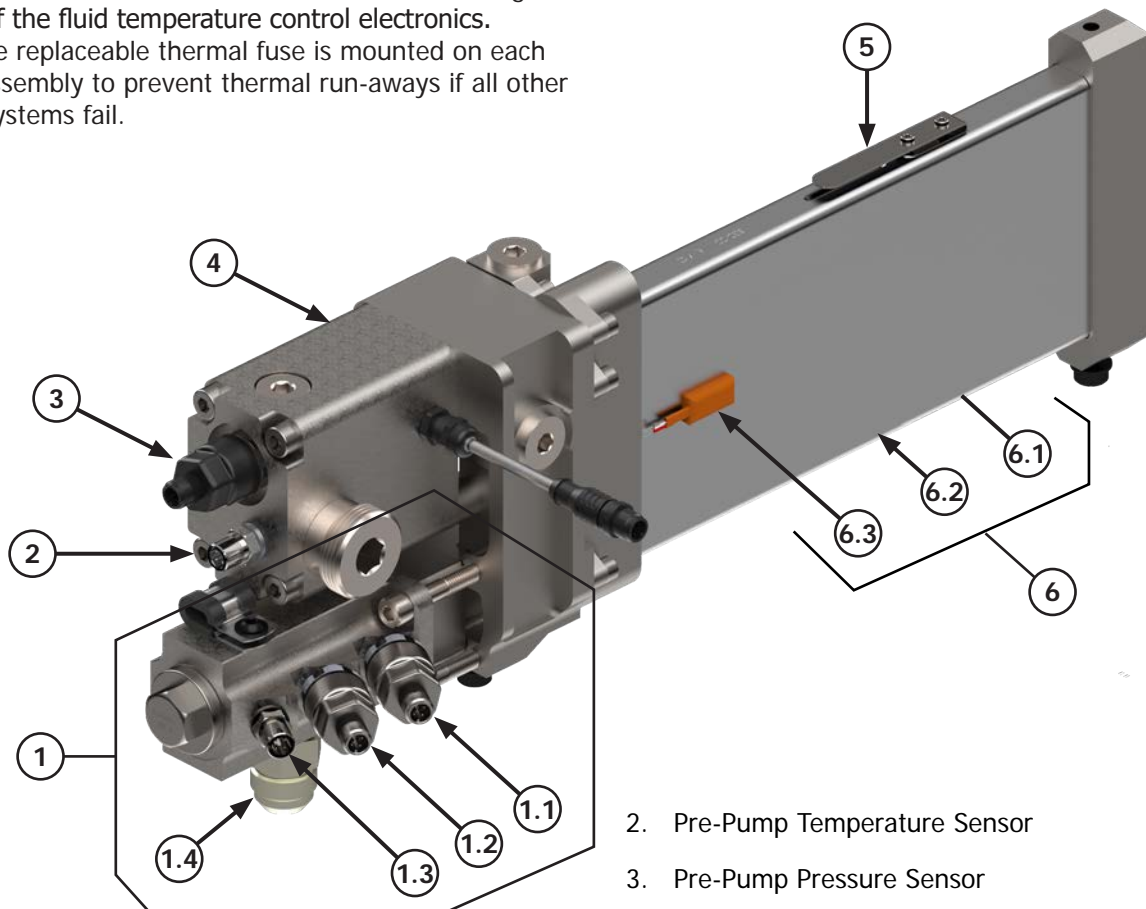

### LOW-PRESSURE MODULE DESCRIPTION

1. Filter Module
  - 1.1 Post-Filter Pressure Sensor
  - 1.2 Inlet Pressure Sensor
  - 1.3 Inlet Temperature Sensor
  - 1.4 Inlet JIC 12 Fluid Fitting
2. Pre-Pump Temperature Sensor
3. Pre-Pump Pressure Sensor
4. Flow Meter
5. Thermal Fuse
6. Preheater Module
  - 6.1 Heater Blanket (Opposite Side)
  - 6.2 Heat Exchanger
  - 6.3 Temperature Sensor

## PUMP MODULE

**Pump Module:** The IS30 uses external gear pumps driven by DC Servo Motors to pressurize and deliver fluid to the distribution (spray gun) hose. This approach minimizes size and response time while maximizing pumping efficiency.

**Fluid Pump:** The IS30 uses external gear pumps to pressurize and deliver fluid to the distribution (gun) hose. These pumps are specially designed to be compatible with isocyanates and resins used in spray foam insulation. They include integrated shaft lubrication housings, hardened gears and shafts, and specially coated journal and thrust bearings for long life.

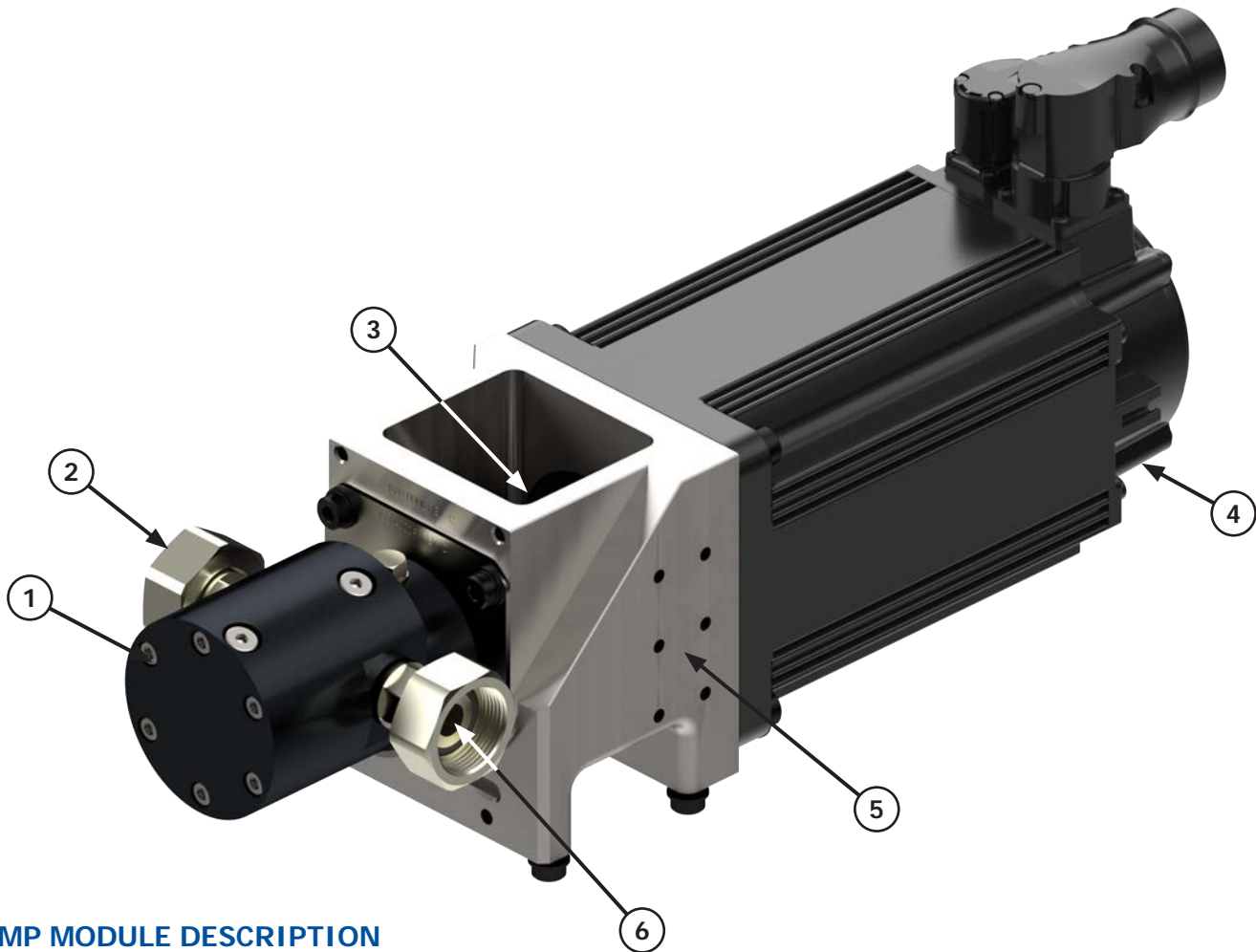

### PUMP MODULE DESCRIPTION

1. Fluid Pump
2. Fluid Union Nut
3. Shaft Coupler
4. DC Servo Motor
5. Pump Mount
6. Fluid Union Nut



## HIGH-PRESSURE MODULE

**High-Pressure Module:** The High-Pressure Module houses the following components:

**Check Valve:** The Check Valve prevents fluid backflow to the low-pressure side of the IS30 Fluid Modules.

**Pressure Sensor:** A pressure sensor is mounted in the High-Pressure Manifold to prevent system overpressure. It is also used for automatic hose pressure sensor calibration (see DISPLAY SCREENS "SETTINGS SCREENS–HOSE CONFIGURATION") and when hose sensor bypass mode is enabled (DISPLAY SCREENS "SYSTEM STATUS SCREENS–SENSOR BYPASS").

**Pressure Gauge:** An analog pressure gauge allows the user to read pressure in the distribution hoses even when the system is not powered.

**Recirculation and Pressure Relief Valve:** The Recirculation valve controls flow to the recirculation hose and includes a pressure relief valve that opens at approximately 3000 psi.

**Burst Disk:** As an additional safety precaution, a burst disk assembly rated for 7000 psi is located at the back of the High-Pressure Manifold; in case of rupture, high-pressure fluid is contained within a well and directed downward and away from other equipment or users. The Burst Disk assembly is a service item that should be replaced annually or more often based on the properties of fluids being sprayed (refer to "SERVICING").

**Hose fittings:** JIC fittings for recirculation and distribution (gun) hoses are at the bottom of the High Pressure Module. Embossed labels on the manifold clearly identify fittings.

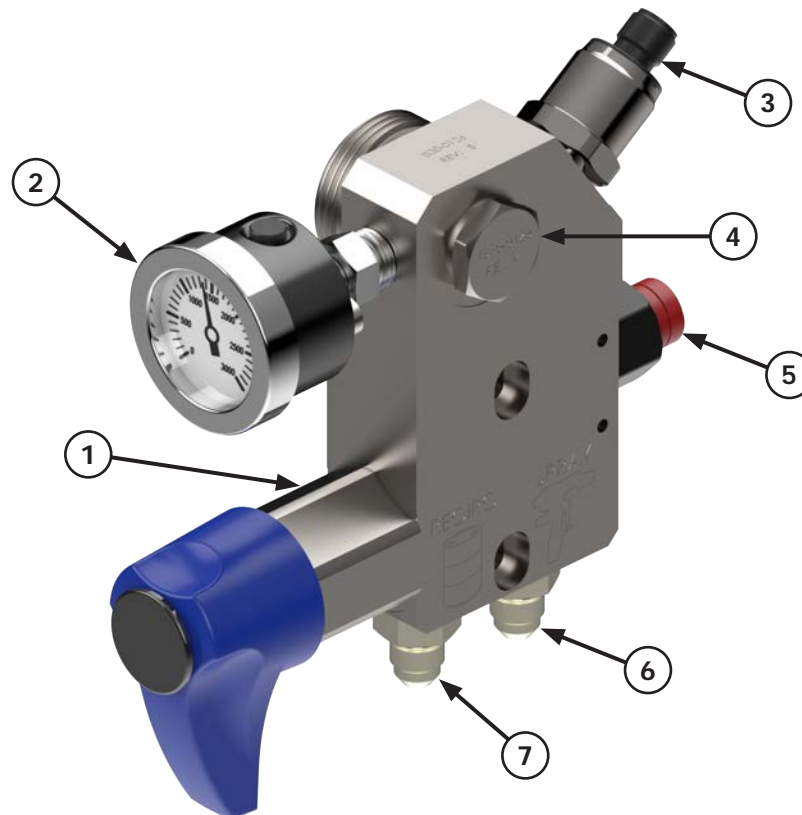

### HIGH-PRESSURE MODULE DESCRIPTION

- |  |  |
|--|--|
| 1. Recirculation and Pressure Relief Valve | 5. Burst Disk  |
| 2. Pressure Gauge                          | 6. Gun Hose: JIC 5 (ISO) or JIC 6 (RES) Hose Fittings      |
| 3. Pressure Sensor                         | 7. Recirculation: JIC 5 (ISO) or JIC 6 (RES) Hose Fittings |
| 4. Check Valve                             |  |

This page intentionally left blank.



## CONTROL MODULE

The IS30 Control Module provides overall system control, touch-screen HMI, power management, circuit protection, motor controls, preheater and hose heater controls, remote connectivity, internal networking, and electrical safety systems. Components are contained in an enclosed sheet metal cabinet that incorporates a thermostatically controlled fan that draws in cooling air through a user-serviceable filter at the bottom of the door.

The IS30 Control Module is constructed with components used in high-duty-cycle industrial environments. The heart of the control module is an industrial-grade controller that senses over 30 inputs (flow, temperature, pressure) and drives over ten outputs up to 1000 times per second. The controller stores job data, recipes, historical performance information, user information, and alarm histories.

The software can be updated remotely or with a USB memory stick.

The 10" high-strength touch-screen allows the user to monitor and control the proportioner and hoses.

The IS30 Control Module provides remote system monitoring, control, and service "out of the box" without any additional hardware, software, or monthly fees. The IS30 Control Module is designed for front-access service while in the proportioner. All components can be replaced in minutes with simple hand tools. All items are labeled, and all wiring is clearly tagged. 200V and 400V wiring diagrams are provided in the "SCHEMATICS" chapter.

The following pages show the location and function of primary components in the Control Module. For additional views and a parts list, see the "MAINTENANCE" chapter. Always be sure the rotary power switch is in the OFF position before opening the Control Module. Due to electrical shock hazards, the Control Module must be serviced only by trained personnel.

### WARNING

**ELECTRICAL SHOCK HAZARD:** Disconnect all power sources before accessing any electrical connections in the Control Module, Fluid Modules, or Hoses. Equipment must only be serviced by qualified persons.

### WARNING

**ELECTRICAL SHOCK HAZARD:** Motor drives contain capacitors that have stored electrical energy for up to 15 minutes after power is shut off. Wait 15 minutes before disconnecting the power cables between the motor drives and the motors.

## CONTROL MODULE—OVERVIEW

The functions of primary components in the Control Module are described below.

**Main Panel:** Most Control Module components are part of the Main Panel assembly. Additional Hook & Loop retention straps are used for DIN rail-mounted components for mobile robustness. Wiring is contained in capped raceways. Additional information on the Main Panel is included in the following pages.

**HMI/Controller:** The IS30 uses a 10" TFT multi-touch HMI (Human Machine Interface) that also contains an industrial Controller; the Controller performs all machine monitoring and control functions while the HMI acts as the interface to the User. This "all in one" device eliminates the need for a separate PLC (Programmable Logic Controller).

The HMI/Controller in the IS30 is specifically designed for the wide range of environmental and mobile conditions to which spray foam equipment is subject.

**Solid State Relays (SSRs):** The IS30 has individual SSRs mounted on a heat sink for all heating zones (A and B preheaters A and B hose sections). SSRs control heating power by modulating current to the respective heating zones. Indicator lights on each SSR show when current is applied to the respective heating zone. When the light is on or flashing, current is flowing to the respective heating zone.

**Cellular Modem and Antenna:** The Cellular Modem and Antenna allow the IS30 to connect to available cellular networks. This will enable users to monitor and control the IS30 from any standard web browser on their phone, tablet, or computer. It also enables users to email Job Reports to selected recipients and allows authorized IntelliSpray service providers to access the system for remote service and software upgrades.

**Cooling Fan:** A thermostatically controlled cooling fan pulls external air through a user-serviceable filter. This helps prevent component overheating in hot environments.

**E-Stop Button:** When pressed, the E-Stop (Emergency) button opens the internal high-voltage disconnects that power preheaters, hoses, heaters, and motors. It is provided as a safety device to stop fluid heating and pumping without pressing the STOP button on the HMI screen.

**Air Filter:** Cooling air is drawn through a user-serviceable air filter in the Control Module. See the "SERVICING" chapter for air filter cleaning instructions.

**Power Switch:** The IS30 rotary Power Switch disconnects all voltage to the unit. It also allows a lock-out padlock to prevent accidental powering on the system when servicing. The switch is ON when pointed to at the I and OFF when pointed at the O.

**USB Ports:** Dual USB ports are provided on the side of the Control Module for attaching accessories and transferring information (e.g., hand-held scanner for scanning drums and memory sticks for transferring job reports, software updates, etc).

**Cable Gland:** An M40 X 1.5 cable gland is provided with each IS30 suitable for 22mm to 32mm cable diameters). A 2/4 SOOW power cable is suitable for most installations, but installers are responsible for selecting the proper cable size and insulation based on installation configuration, cable length, and environmental conditions.

## CONTROL MODULE-ENCLOSURE

The main components of the Control Module are shown in the figure below and described in the following pages.

All items and cables in the Control Module are clearly marked to assist in diagnostics and service.

### CONTROL MODULE DESCRIPTION

- |                     |                                   |
|---------------------|-----------------------------------|
| 1. HMI/Controller   | 7. Cable Gland                    |
| 2. Cellular Modem   | 8. Power Switch                   |
| 3. Cooling fan      | 9. Emergency Stop Button Contacts |
| 4. Beacon Light     | 10. Air Filter                    |
| 5. Dual USB Ports   | 11. Cover Latches (x2)            |
| 6. Cellular Antenna |                                   |



INTERIOR DESCRIPTION

- 1. Cooling Fan
- 2. Main Panel
- 3. Dual USB Plugs
- 4. Power Cord Entry
- 5. Power Switch
- 6. EMI Enclosure
- 7. Hose Heat Power
- 8. Hose Communication
- 9. Hose Power

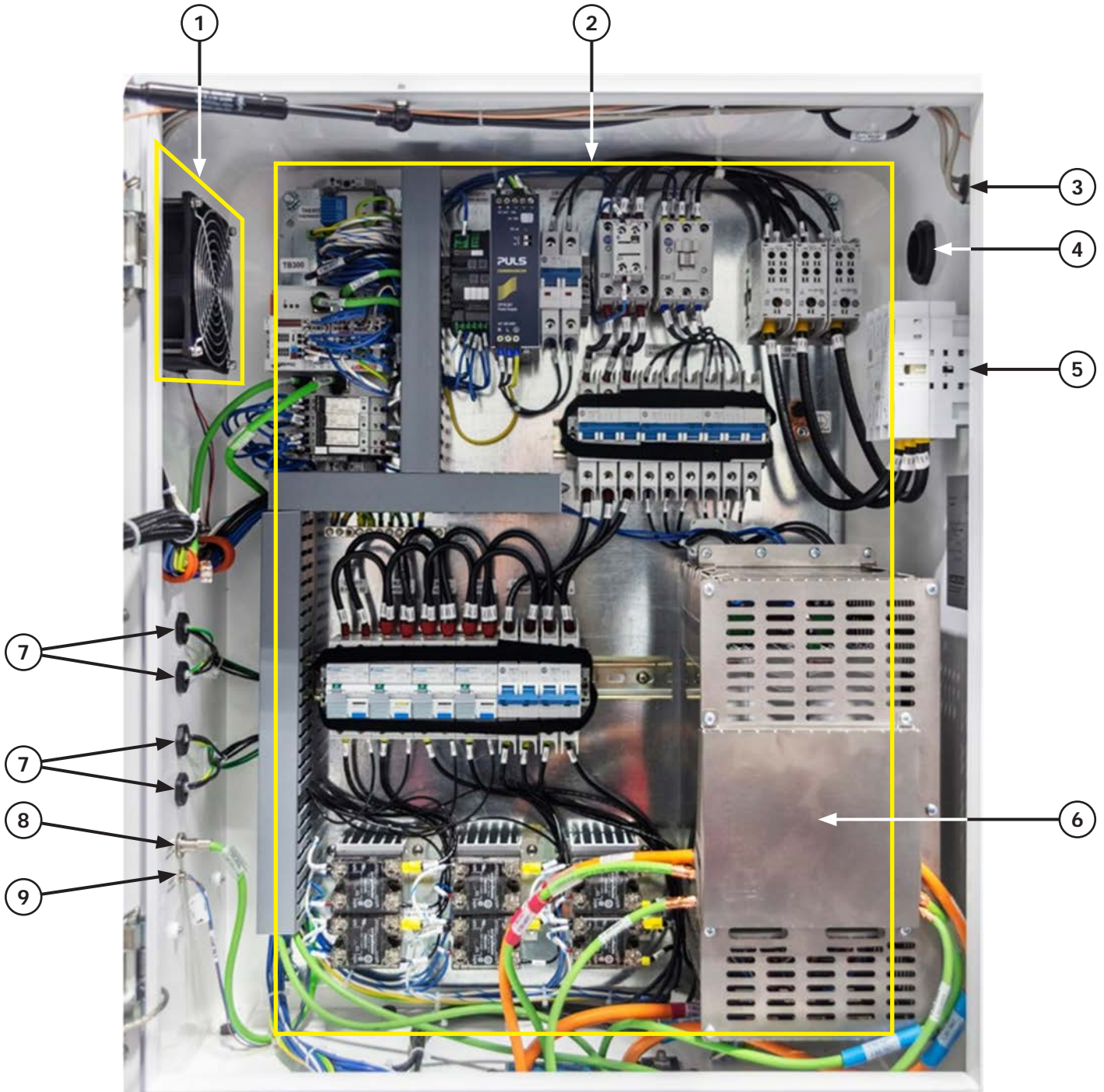



**DOOR DESCRIPTION**

1. HMI
2. Cellular Modem
3. Emergency Stop Switch
4. Cover Latch (x2)
5. HMI Controller
6. Filter Assembly

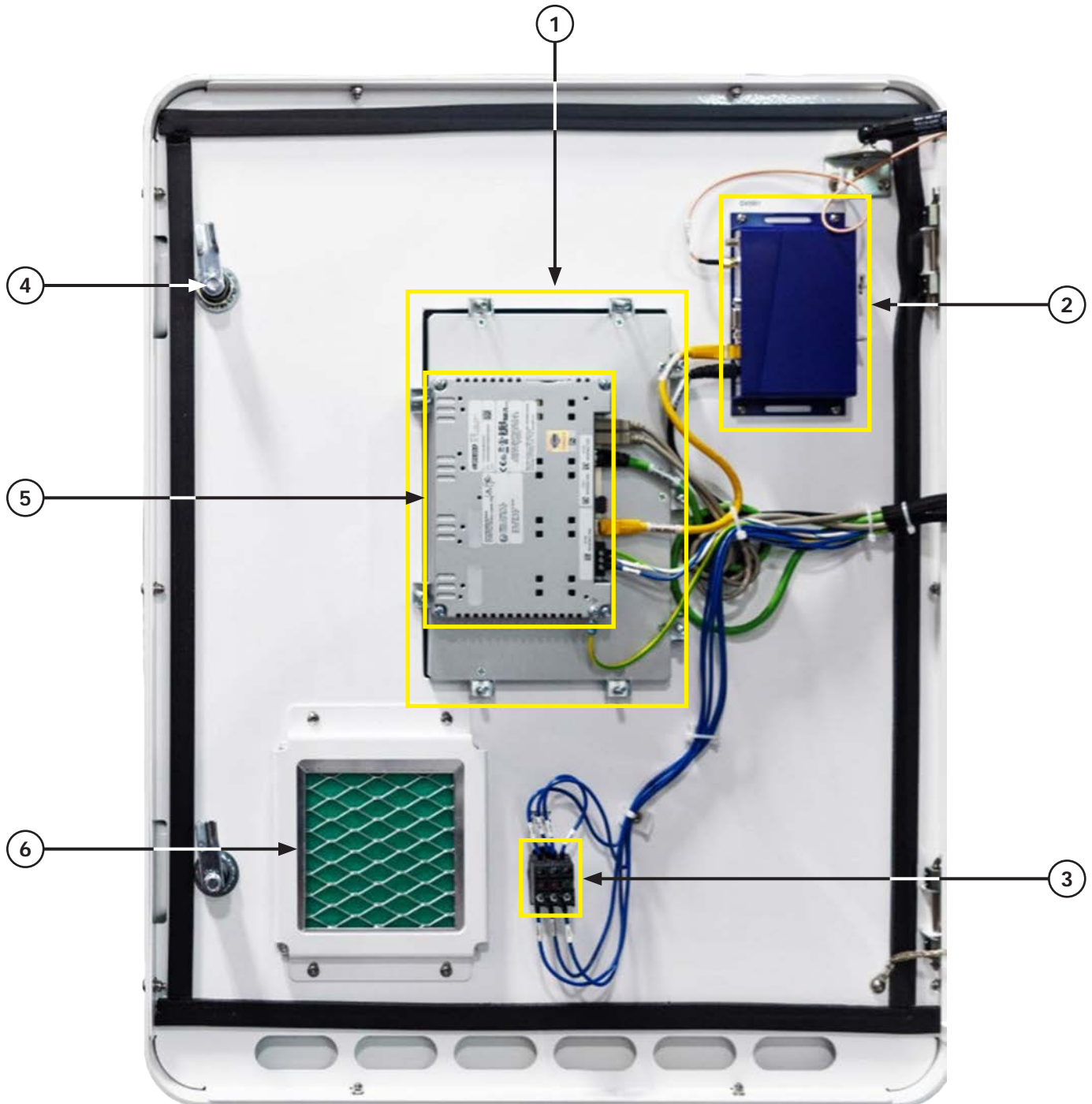

**CONTROL BOARD-200V**

Most Control Module components are part of the Main Panel and are shown in the following figure. Additional Hook & Loop retention straps are used for DIN rail-mounted components for mobile robustness.

The wiring is contained in capped Raceways and is clearly labeled. All components are clearly labeled on the Main Panel. Wiring schematics are included in the "SCHEMATICS" chapter.

**CONTROL BOARD DESCRIPTION**

1. Bank 2 Circuit Breakers (Low Voltage Systems)
2. 24V Electronic Breaker
3. 24V Power Supply
4. Power Supply Circuit Breakers
5. Contactors
6. Main Terminal Blocks
7. Panel Ground
8. Bank 1 Circuit Breakers (Heating and Motors)
9. Preheat Circuit Breakers
10. B (RES) Motor Drive
11. A (ISO) Motor Drive
12. Thermostat
13. Terminal Blocks
14. EtherCat Coupler
15. PLC Modules
16. EtherCat Modules
17. Relays
18. Bank 3 Circuit Breakers (Heating Zones)
19. Bank 3 Hose Heat GFCIs
20. Heater SSRs (Solid State Relays)

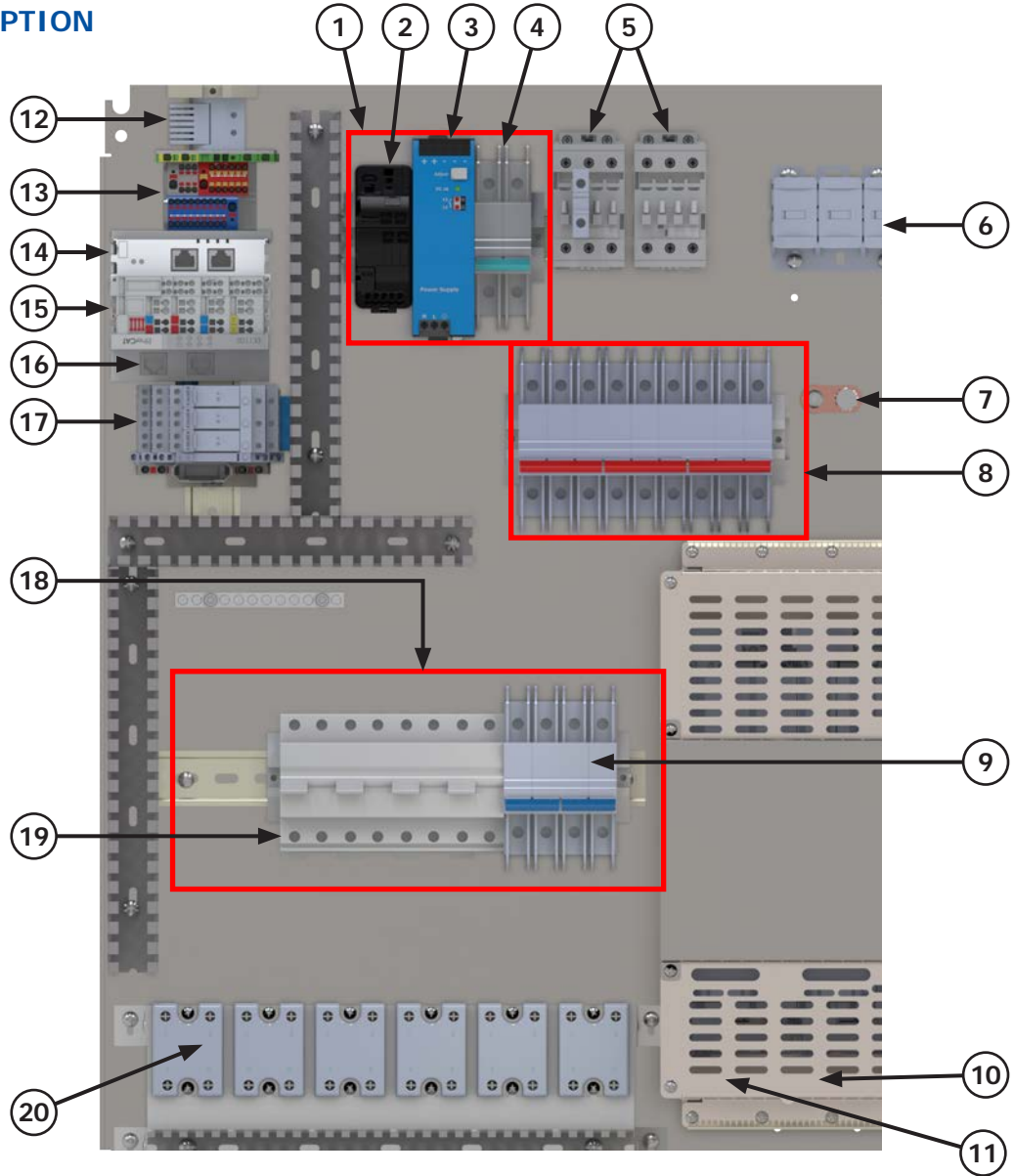

## CONTROL BOARD-400V

## CONTROL BOARD DESCRIPTION

1. Bank 2 Circuit Breakers (Low Voltage Systems)
2. 24V Electronic Breaker
3. 24V Power Supply
4. Power Supply Circuit Breakers
5. Contactors
6. Main Terminal Blocks
7. Line Filter
8. Panel Ground
9. Bank 1 Circuit Breakers (Servo Drive)
10. B (RES) Motor Drive
11. A (ISO) Motor Drive
12. Thermostat
13. Terminal Blocks
14. EtherCat Coupler
15. PLC Modules
16. EtherCat Modules
17. Relays
18. Diode Zener
19. Bank 3 Circuit Breakers (Heating Zones)
20. Neutral Distribution Blocks
21. Hose and Preheat SSRs
22. Bank 3 Hose Heat Residual Circuit Breakers with Over-current
23. Bank 3 Preheat Circuit Breakers
24. Terminal Block, Ground

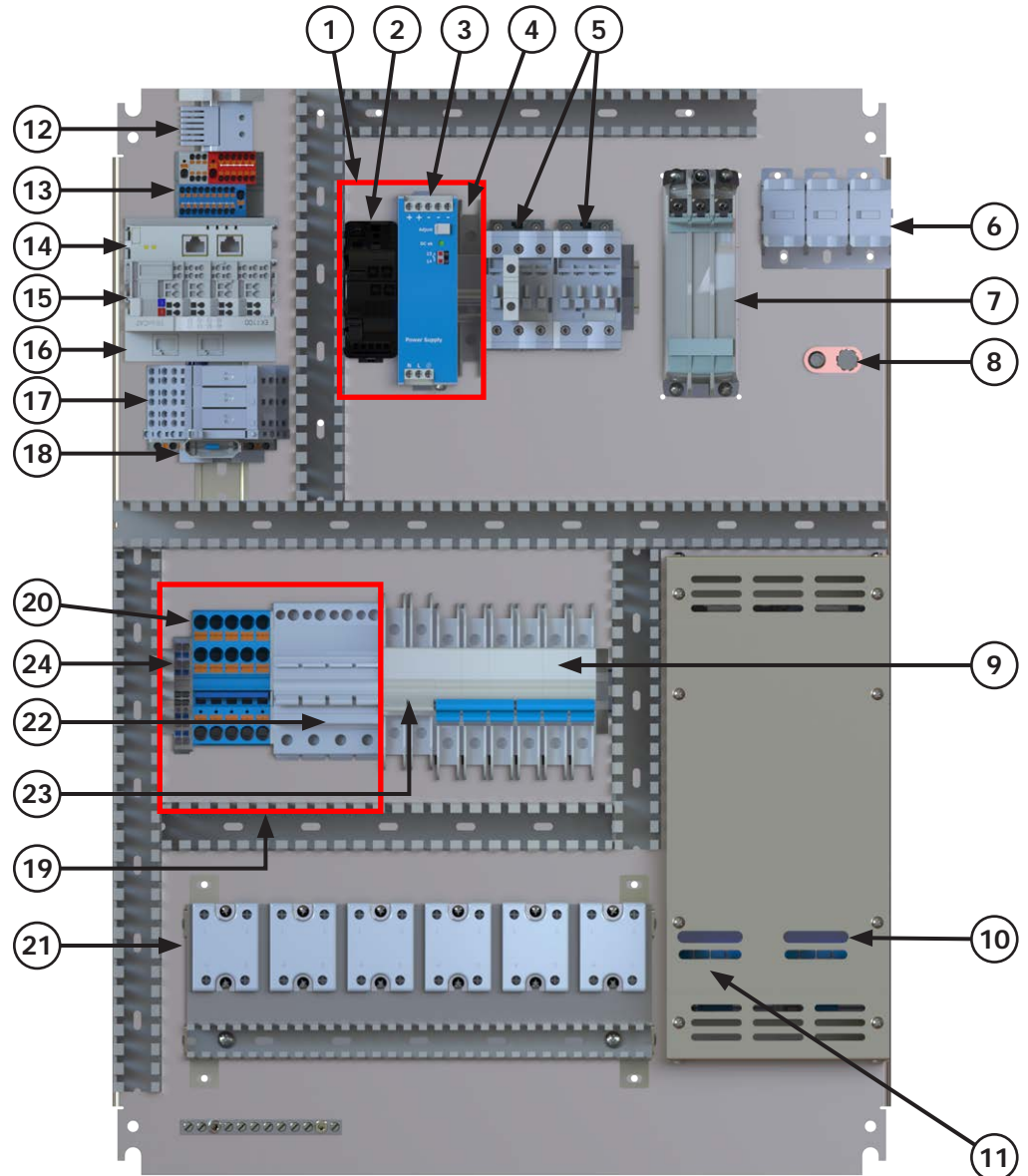

This page intentionally left blank.



## CIRCUIT BREAKERS

A circuit breaker is a switch designed to automatically protect an electrical circuit from damage caused by overcurrent, overload, or short circuit situations. Protective relays inside the circuit breaker detect a fault and “trip” to open contacts that interrupt current flow. Circuit breakers in the IS30 Main Panel protect all electrical circuits and components in the IS30 Proportioner and QuickHeat hoses. Circuit breakers and their electrical hierarchy also allow easier identification and isolation of the location or component that causes the fault. If a circuit breaker opens (trips), there is always an underlying reason that should be investigated and resolved by a trained technician. In most cases, resetting (closing) a circuit breaker will not resolve the underlying issue. The IS30 Circuit Breakers are contained in several banks, as shown on the previous pages.

Bank 1 (shown below) contains the main circuit breakers that feed all other circuits through Bank 2 and 3, as shown on the next page. Circuit Breakers are clearly labeled on the panel.

The purpose and status of circuit breakers in each Bank are shown and described below and on the following page.

**CB Bank 1:** Bank 1 contains either 200V or 400V main circuit breakers for Heating (preheaters and hoses) and A and B Pump Motors.

Breakers are closed (“hot”) when switched upward when viewing from the front of the panel. A red indicator is also shown when the breakers are closed. When open or tripped, the breaker switches are pointed down when viewed from the front, and green indicators are also shown.



Bank 1 Breaker Closed/Hot

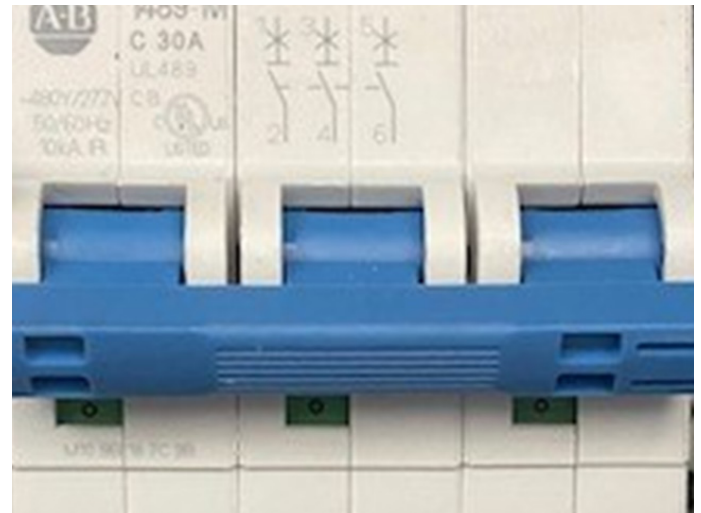

Bank 1 Breaker Open/Tripped

### ⚠ WARNING

**ELECTRICAL SHOCK HAZARD:** Disconnect all power sources before accessing any electrical connections in the Control Module, Fluid Modules, or Hoses. Equipment must only be serviced by qualified persons.

**CB Bank 2:** Bank 2 contains an AC circuit breaker for the 24V DC Power Supply. It also has an electronic circuit breaker for individual low-voltage circuits for the Servo Drives, HMI/PLC, Cooling Fan, QuickHeat Hose Modems, and Fluid Module I/O.

The table and figure below indicate the electronic circuit breakers' status.

## CIRCUIT BREAKER DESCRIPTION

1. Channel 1: Servo Drives
2. Channel 2: HMI/PLC and Safety Circuit
3. Channel 3: Hose Sensing and Communications
4. Channel 4: Fluid Module 24VDC

Circuit Breaker Status Indicators		
Green	Connected	Function OK
Red	Disconnected	Manually Disconnected
Green Flashing	Threshold	Load Above 90% of Operating Current Limit
Red Flashing @ 1 Hz	Disconnected	Over Current
Red Flashing @ 5 Hz	Defect	Internal Fault

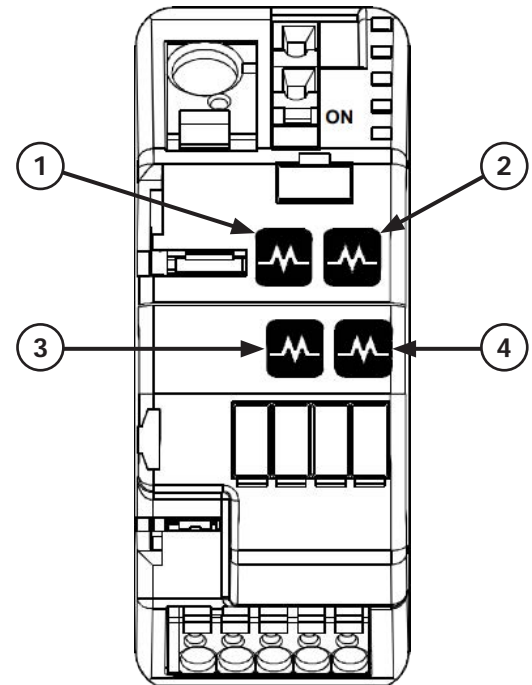

**CB Bank 3:** Bank 3 contains individual circuit breakers for the A and B Preheaters and each section of the A and B hoses (up to 2 hose sections or four individual hose heating zones).

Hose circuit breakers also act as GFCIs (Ground Fault Circuit Interrupts) to protect personnel or property from electrical current leakage from the hose. Breakers are “hot” (closed or ON) when switched to the right (when viewing from the front). When closed, a red indicator is also shown for each breaker pole.

When open or tripped (OFF), the breaker switches are pointed to the left when viewing from the front and also show green indicators.



Bank 3 Breaker Open/  
Tripped (OFF)

Bank 3 Breaker Open/  
Closed/Hot (ON)

## ⚠ WARNING

**ELECTRICAL SHOCK HAZARD:** Disconnect all power sources before accessing any electrical connections in the Control Module, Fluid Modules, or Hoses. Equipment must only be serviced by qualified persons.

## QUICKHEAT™ HOSE-OVERVIEW

The IS40 and IS30 proportioners are specifically designed to use Carlisle QuickHeat™ Hoses. These hoses contain high-power internal electric heating cables, ensuring all heating energy is transmitted directly to the fluid.

QuickHeat hoses are provided in 50, 100, 150, and 200ft lengths (main hose lengths). The Smart Ends (connected as extensions to the main hose sections) are provided in 20, 25, and 40ft lengths, with the 25ft version having increased flexibility. Connected to the end of the Smart End is an unheated, insulated whip. This comes in 3, 4, 6, and 10ft lengths, with the 4ft version having increased flexibility.

Each length of a heated hose begins with a fluid manifold or “modem” that may contain pressure and/or temperature sensors, heater cable connectors, and electronics used to send information over the hose to the Proportioner Control Module. With this approach, no sensor power or communication cables are required, which are a common source of hose failures in other systems. It also provides the architecture for two-way communication between the hose, proportioner, and remote devices.

The QuickHeat hose has roughly double the heating power compared to most other SPF hoses. It directly heats the fluid from inside the hose, which results in fast and efficient fluid heating, even in cold climate conditions.

QuickHeat hoses have embedded temperature and pressure sensors, independent A & B hose heating, and up to four independent heating zones to improve temperature control.

QuickHeat hoses provide sensor power and signal communication without cables or connectors, providing high reliability while reducing failure points.

QuickHeat hoses include a snag and abrasion-resistant outer hose wrap that is sealed with industrial-grade hook & loop material to allow individual A or B-side hose replacement.

Product Features:

- Fast and reliable heat. Independent A & B embedded heater wire submerged in hose fluid achieving > 100°F (37°C) DeltaT in under 15 minutes on average.
- Real-time system control. Pressure and temperature data communicated and controlled within the hose to spray gun to maximize control and accuracy.
- Cut service costs. Reduced need for service with fully potted electronics/sensors and the ability to replace A & B side independently when needed.
- Reduced electrical connections, resulting in fewer maintenance issues.
- More heat control and less risk. Independent heat sensors allow the system to adjust temperature.
- Lighter and more flexible hoses for less sprayer fatigue.

Refer to the QuickHeat Hose Product Manual for more information and instructions on assembling and connecting QuickHeat hose to the IS30 or IS40 Proportioners.

### WARNING

**ELECTRICAL SHOCK HAZARD:** Disconnect all power sources before accessing any electrical connections in the Control Module, Fluid Modules, or Hoses. Equipment must only be serviced by qualified persons.

This page intentionally left blank.

## INSTALLATION-OVERVIEW

**Note:** IS30 installation requires that a QuickHeat™ hose is fully assembled and ready for connection to the IS30. See "QuickHeat™ Hose Manual" for more information.

Installation of the IS30 should only be performed by individuals with prior knowledge of installing and servicing Spray Foam equipment.

Installation involves mechanical, electrical, and fluid connections. Out-of-box software settings are usually adequate for initial system use but can be changed by the installer to meet specific needs.

Every IS30 is equipped for remote support and can be accessed by authorized IntelliSpray service agents to assist in system installation, configuration, and/or service.

The following steps outline the installation of the IS30.

1. Unpack the unit and remove it from the shipping pallet.
2. Place the unit in the desired location.
3. For mobile or seismic environments, make mechanical connections to the floor and wall of the structure.
4. Check to be sure the power to the IS30 circuit is off (turn off the breaker at distribution or main panel).
5. Make electrical connections inside IS30 Control Module:
  - For 200 - 240V system, make electrical and ground connections inside IS30 Control Module.
  - For 380 - 415V system, make electrical, neutral and ground connections inside IS30 Control Module.
6. Connect fully assembled QuickHeat™ hose master modem to fluid jumper hoses.
7. Connect fluid supply and recirculation hoses to A and B fluid modules.
8. Set Fluid Module valves to spray position for purging.
9. Close gun manifold material control valves and remove the spray gun from the hose.
10. Open fluid supply lines and pressurize drum pumps to provide inlet fluid pressure of 150-200 psi:
  - 2:1 drum pump air pressure of 75-100 psi.
  - 3:1 drum pump air pressure of 50-70 psi.
11. Energize the IS30 power circuit at the distribution or main panel.
12. Turn on the IS30 power switch (side of the control panel). The startup screen will appear in 30-60 seconds.
13. If the Proportioner and Hoses were configured together at the factory, skip steps 13a to 13d. If the Proportioner was not configured at the factory, configure hoses as shown in DISPLAY SCREENS "SETTINGS SCREENS-DISPLAY SETTINGS."
  - From the main menu, open Settings > Hose.
  - Select hose configuration.
  - Press Unpair Modems - Once completed press Pair Modems - Ensure no other IntelliSpray Machines are On when pairing modems.
  - Scan and select a recommended communication frequency.
14. Purge A and B fluid sections (and hoses if new or empty) to eliminate air. See DISPLAY SCREENS "EXAMPLE 1-INITIAL SYSTEM BLEED" for detailed instructions on first-time system purging.
15. Follow the quick start instructions in chapter "QUICK START GUIDE" to begin spraying.

### ! WARNING

Installation of the IS30 exposes installers to high voltages and high fluid pressures. Severe injury or death can result from incorrect installation or installation techniques.

### NOTICE

The IS30 requires QuickHeat™ hoses for operation. Do not substitute QuickHeat™ hoses with other hose brands.

## INSTALLATION PROCEDURE

### STEP 1. UNPACK THE UNIT

The IS30 Proportioner is shipped securely mounted to a shock-absorbing dual-layer pallet. Screws are used to secure the base of the unit to the pallet. A dual-layer cardboard cover, enclosure, and heavy-duty plastic bag protect the unit during shipping and storage.

After the cardboard covers and top sheet are removed, put the pallet with the IS30 near the desired location for installation. When removed from the shipping pallet, leave adequate room to work around the unit.

Remove the four screws (1) that keep the IS30 attached to the pallet. Lift the unit off the pallet by the tubular frame members, and use ramps or blocks to slide or walk the unit down to floor level as needed.

### STEP 2. PUT IN PREFERRED LOCATION

Slide, lift, or “walk” the unit into the desired location. Slide the unit on plastic or cardboard sheets to position the IS30. Keep adequate room behind, above, and beside the unit to route the power cable and supply hoses.

#### **⚠ WARNING**

The IS30 weighs approximately 415 lbs. Use extreme caution to prevent unit tip-over and injury to the installers.





### STEP 3. SECURE THE UNIT

If the IS30 is used in a mobile or seismic environment, the frame must be secured to a rigid floor and wall using 5/16" (or larger) grade 8 fasteners and washers.

The IS30 frame has integral floor and wall mounting brackets for this purpose.

Use eight bolts or lag screws to secure the flooring and four to secure the unit to the wall. Additional support members, through-wall bolts, and external braces may be required depending on the wall's strength.

#### ! WARNING

Make sure the electric power is turned off to the IS30 before the electrical connections are made or when the Control Module is open.



Floor mounting brackets on frame

### STEP 4. TURN OFF ELECTRICAL POWER

Verify the IS30 is on a dedicated 80A 200-240V 3-Phase or 60A 380-415V 3-Phase + Neutral protected circuit.

Make sure that the supply branch circuit is turned off and appropriate lock-out-tag-out safety measures are in place. This prevents personnel from accidentally energizing the circuit during installation.

#### ! WARNING

The installers are responsible for properly securing the IS30 in position to prevent movement or tipping in use or transportation. Severe injury or death may result if the unit is not secured in place.



Wall mounting bracket on frame

## STEP 5. MAKE ELECTRICAL CONNECTIONS

Open the Control Module by rotating the upper and lower front cover latches on the front of the cabinet to the open (vertical) position.

Insert appropriately rated four conductor power cords through the M40 X 1.5 cable gland provided with each IS30 (suitable for 22mm to 32mm cable diameters).

Tighten the gland nut to secure the cable. A 2/4 SOOW power cable is suitable for most installations, but installers are responsible for selecting the proper cable size and insulation based on installation configuration, cable length, and environmental conditions.

Connect the power cord phase wires to the power switch module inside the Control Module using an M4 hex key torqued to 55 in-lb. Connection order is arbitrary.

Connect the power cord ground wire to the panel ground lug with an M6 hex key torqued to 35 in-lb. After completing the electrical connections, close and latch the Control Module cover.

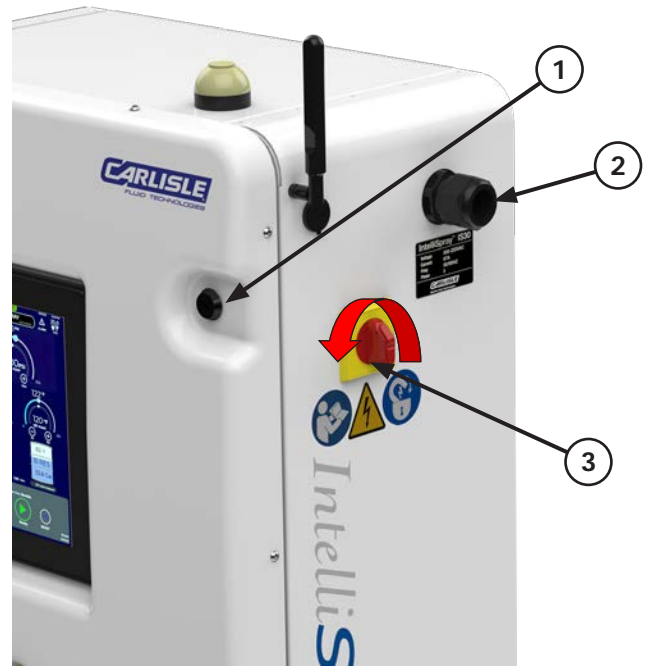

### ⚠ WARNING

The installer is responsible for selecting the power cable or wire that has the appropriate ampacity and environmental ratings for the IS30 system. The use of undersized power cables or wires can result in electrical shorts and/or fire.

### ⚠ WARNING

The installer is responsible assuring power and ground connections are secure and conductors are not damaged. Loose or damaged connections can lead to fire, serious equipment and/or property damage, physical injury or death.

## INTERIOR CONNECTION DESCRIPTION

1. Front Cover Latches
2. M40 x 1.5 Cable Gland
3. Power Switch
4. Ground Wire Connection
5. Power Connections

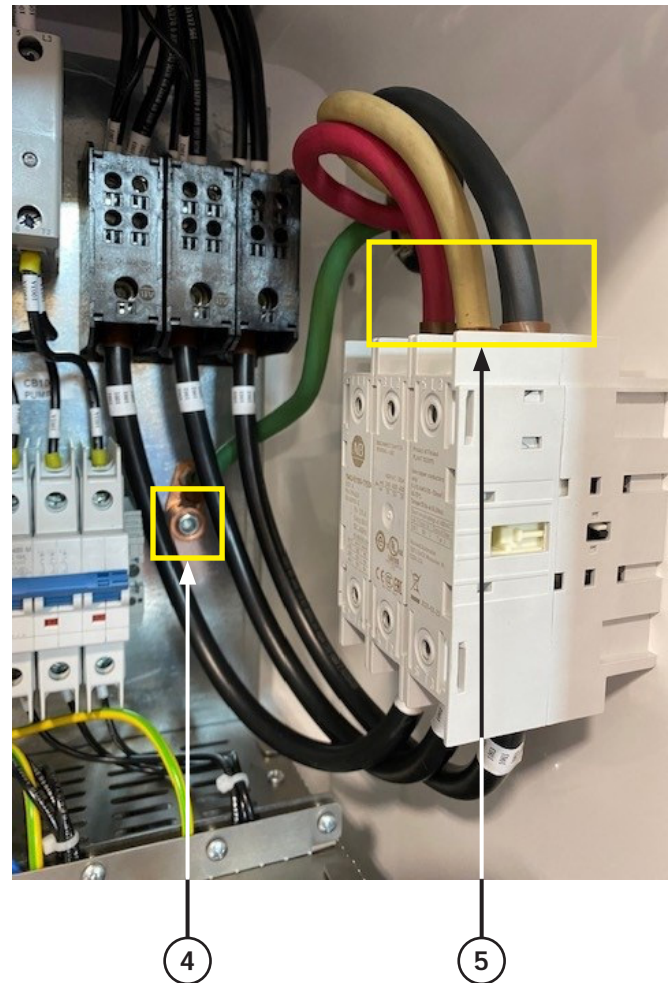



## STEP 6. QUICKHEAT™ HOSE CONNECTION

Lift and slide the Master Modem cover off its bracket. Remove upper and lower hose clamp bolts and outer clam shells. Set the Master modem in its bracket.

Note: zip-ties can help hold the modem in place when attaching hoses.

Using the flats method described in the QuickHeat™ Hose Manual, connect the A and B jumper hoses to the respective master modem fluid connections. The A and B fluid connections use JIC 5 and JIC 6 fittings, respectively, and are color-coded (A side red, B side blue) to prevent cross-connecting.

Do not overtighten; damaging the fluid fittings may require a complete hose section replacement. Applying spray-gun grease to the A-side JIC threads will allow easier removal if service is required.

Secure the modem into its retention bracket using the upper and lower hose clamps, tightening the retention bolts to 15 lb-ft. Plug in the A and B heater power plugs to their respective mating connectors (each is labeled by zone and side). No tools are required.

Connect the hose DC power and communication cables to their respective sockets on the side of the IS30. Take care to align the connectors in their keyed position, insert, and then tighten the retention ring. No tools are required.

Connect the gun air hose (contained in the QuickHeat™ Hose assembly) to the rig air supply using a 1/4" type M QD. Use cable zip ties to secure electrical cables to the hoses. (This is not required but helps keep the electrical cables under the master modem cover). Reinstall the Master Modem cover onto its bracket.

Refer to the QuickHeat™ Hose manual for more detailed instructions.

### QUICKHEAT™ HOSE CONNECTION DESCRIPTION

1. Master Modem Cover
2. Upper Hose Clamp (torque to 15 lb-ft)
3. Master Modem Bracket
4. Hose Communication Plug
5. Hose DC Power Plug
6. Hose Power Plugs
7. Lower Hose Clamp (torque to 15 lb-ft)

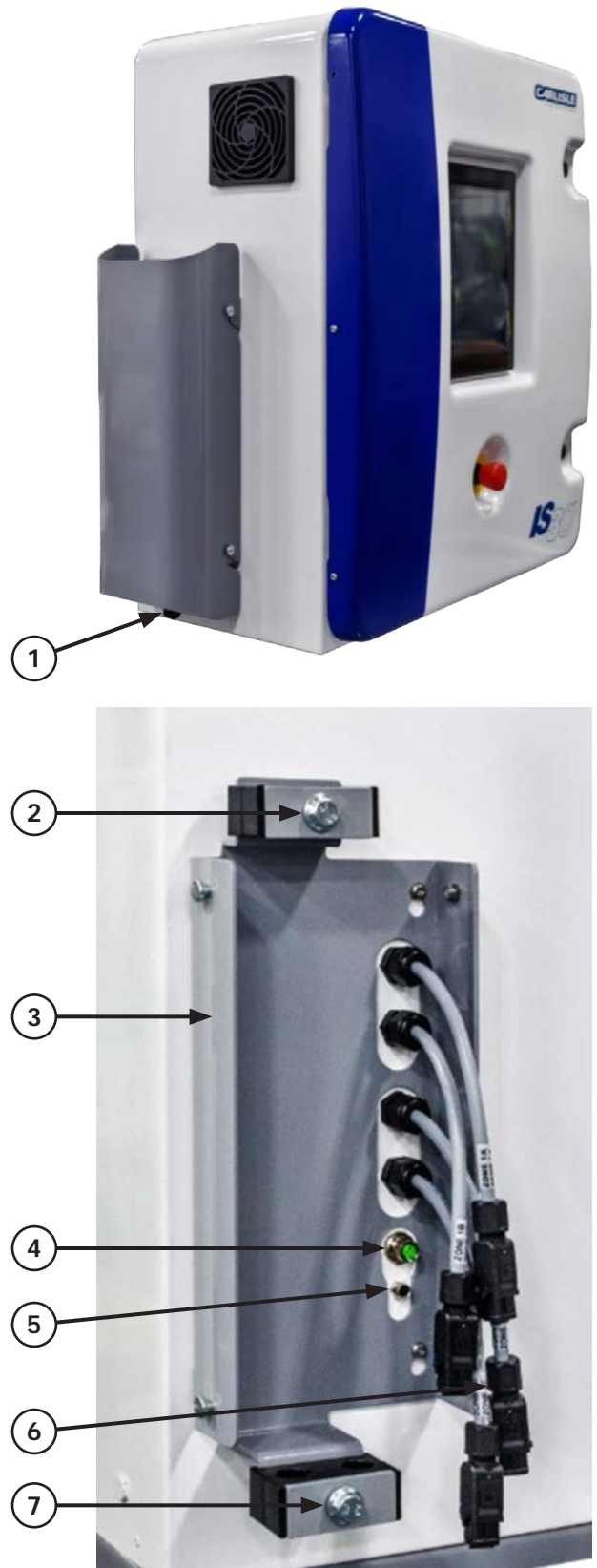

## STEP 7. FLUID SUPPLY AND RECIRCULATION CONNECTIONS

Begin with either the A or B fluid module, and loosen the 5/16" socket head captive screw that holds the module to the IS30 frame.

Pull the spring-loaded locking pin on the outside of the module.

Slide the module forward using the front handle to the 1st or 2nd service position (indicated by holes for the locking pin to engage).

This gives easier access to connect the recirculation and supply lines. While not required for installation, the fluid module cover can be removed by loosening the two M4 socket head cover screw covers.

Remove the cover by pulling it forward.

Connect the supply line to the male JIC 12 inlet fitting on the corresponding Fluid Module. Use installation kit PN 341133 (included with IS30) with 90-degree 3/4" sweep, swivel fittings, and ball valve for easier installation (shown on the next page).

**Make sure to connect the corresponding supply hose to the correct module (A to A, B to B)!**

### CONNECTION DESCRIPTIONS

1. M4 Cover Screws (two per module)
2. 5/16" Captive Socket Head Cap Screw
3. A Side Locking Pin (pull to release)
4. Fluid Supply Hose Fitting (3/4" JIC 12)
5. Recirculation Hose Fitting (JIC 5 A, JIC 6 B)

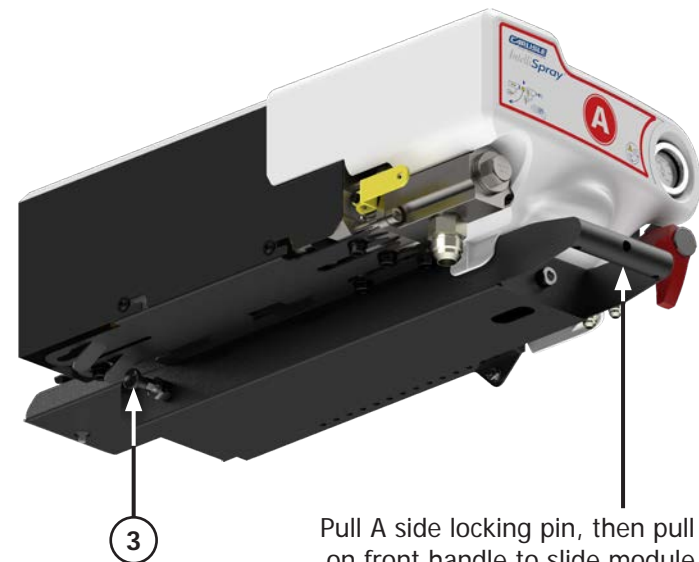

Pull A side locking pin, then pull on front handle to slide module into servicing position.

Connect the recirculation line to the corresponding module (JIC 5 on A module, JIC 6 on B module). Use installation kit PN 341133 to connect to 1/4" NPT recirculation hoses (See figures on the following page).

Do not overtighten JIC fittings, which may damage them, and require a hose or fitting replacement. Applying spray gun grease to the A-side JIC threads will allow easier removal for service if required.

Pull the locking pin out, slide the module back into position, engage the locking pin, and secure the retention cap screw.

Repeat the previous steps on the other module (A or B) to complete the supply and recirculation hose connections.

Replace module covers if removed and secure with M4 button head screws.

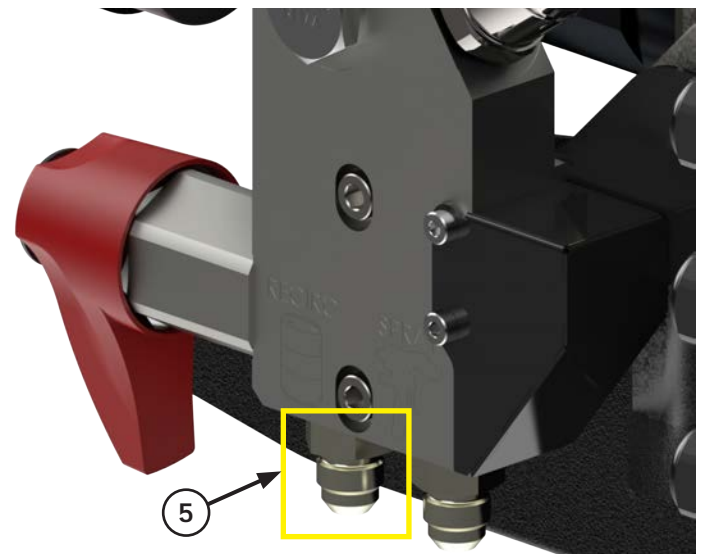
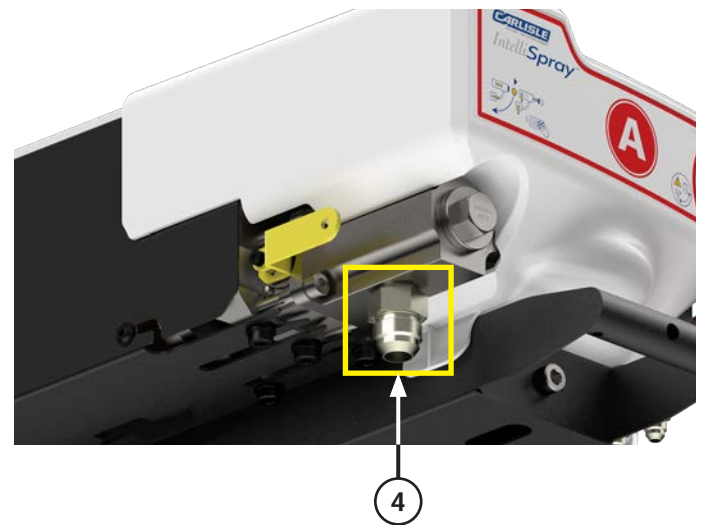

## STEP 8. SET FLUID MODULE VALVES FOR MATERIAL PURGE

Set inlet, filter, and recirculation valves (for each module) in the spray position as shown in the figure.

1. Filter Valve Open (horizontal position)
2. Spray (Gun) Position (valve points down)



### STEP 9. CLOSE GUN MANIFOLD VALVE AND SPRAY GUN REMOVAL

In preparation for purging the system or air, check to be sure the material control valves on the gun manifold are in the closed position and remove the spray gun from the manifold.

### STEP 10. FLUID SUPPLY LINES AND DRUM PUMP PRESSURIZATION

Examine the drum pumps and verify they provide fluid pressure to the IS30. Make sure that all ball valves on the supply lines are in the open position.

The IS30 senses pressure at the inlets or each module. An inlet pressure of 150–200 psi is usually adequate to prevent cavitation of the gear pumps when the supply (drum) pumps reverse direction. If low (or no) pressure is detected, the system will display an error message requiring user intervention before purging the system.

Recommended air pressure on the drum pumps (static and dynamic) should be as follows:

- 2:1 drum pump air pressure of 75 - 100 psi
- 3:1 drum pump air pressure of 50 - 70 psi

Inlet fluid pressure can be checked on the IS30 display panel after the system is turned on.

### STEP 11. ENERGIZE THE POWER CIRCUIT

Close any upstream breakers and/or disconnects to provide electrical power to the IS30.

### STEP 12. TURN ON THE IS30

Rotate the power switch on the side of the Control Module to the "ON" (I) position. The IS30 will display a startup screen while it performs internal system checks.

Once completed, the Spray Mode screen will be displayed

(30-60 seconds after powering on).

### STEP 13. CONFIGURE FOR HOSE SETUP

If the Proportioner and Hoses were configured together at the factory, skip this step. If not, refer to the instructions starting in DISPLAY SCREENS "SETTING SCREENS-HOSE CONFIGURATION" to set the hose configuration, pair hose modems, and select communication frequency.

### STEP 14. PURGE SYSTEM

To fill the IS30 and hoses with material, follow the instructions in DISPLAY SCREENS "EXCHANGE SCREEN" for first-time system purging.

### STEP 15. START THE IS30

Refer to the quick start instructions in the "QUICK START GUIDE" chapter to begin using the IS30.





## QUICK-START GUIDE

Due to the IS30's efficient heating systems and simplified startup process, operators will usually be ready to spray within 10-15 minutes of powering the system. The following are the minimal steps in starting the IS30 with Job Reporting turned off. See DISPLAY SCREENS "DISPLAY SCREENS-REPORTS" for additional steps required when Job Reporting is turned on.

### STEP 1. PRIOR TO START-UP

Before starting the IS30, remove all hoses from the rack and position them for spraying. Make sure the drum pumps are on and the A and B fluid module valves are in the proper position for spraying.

### CONNECTION DESCRIPTIONS

1. Filter Valve Open (horizontal position)
2. Spray (Gun) Position (pointed down)



### STEP 2. START THE UNIT

Turn on the IS30 by rotating the power switch on the right side of the control module clockwise to the ON position (indicated by the character "I").



The IS30 will display a startup screen while it performs internal system checks. Once completed, the Spray Mode screen will be displayed. Note that the Exchange Mode screen can be set as the default startup screen if desired. See DISPLAY SCREENS "SETTINGS SCREENS-SYSTEM STATUS."



### STEP 3. A-ISO and B-RES FLUID LEVELS

Check the A-ISO and B-RES fluid levels using a dip-stick and enter the amount by pressing the drum icon on the screen.



Press to enter drum level.

Enter value, then press Enter to Save

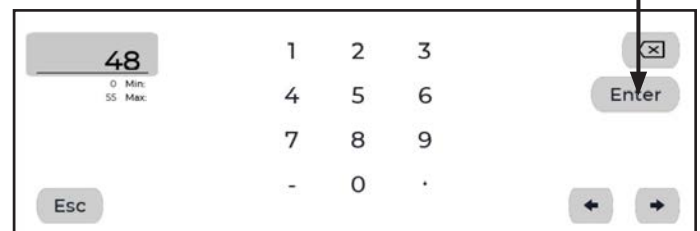

### STEP 4. PRESSURE AND TEMPERATURE SETPOINTS

Enter the desired pressure and temperature setpoints using the on-screen "+" and "-" buttons.

Pressure setpoint

Press "-" to decrease or "+" to increase pressure.

Press "-" to decrease or "+" to increase A temperature.

A-side temperature setpoint

Press "-" to decrease or "+" to increase B temperature.

B-side temperature setpoint

### STEP 5. UNIT WARM UP

Press the **START** button to begin warming up the system.

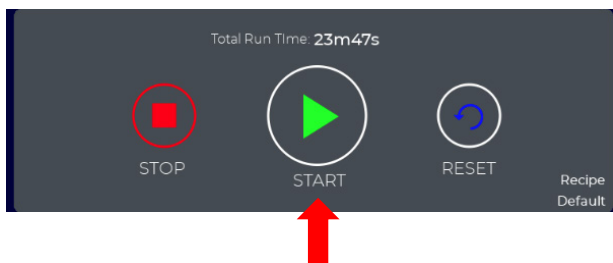

After the button has been pressed, it will change from **START** to **WARMING**; the button boundary will change from solid white to flashing green to indicate the system is in warm-up mode.

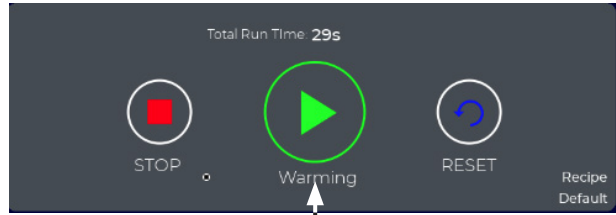

Indicates the system is in warm-up mode

Once the center button changes from WARMING to READY, then the pumps will automatically pressurize the system to the desired setpoint.

### NOTICE

If the IS30 detects a slow warmup in one of the hose temperature sensors, the START button will change to a flashing yellow "WARMUP BYPASS" button.

A press of the button will initiate READY mode. For more information about the WARMUP BYPASS feature, start the Proportioner.

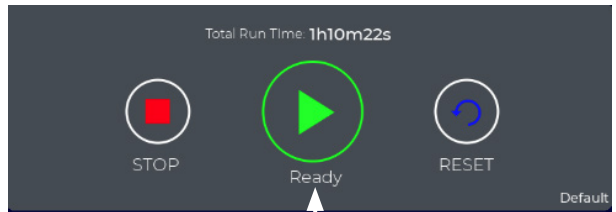

Indicates the system is ready to spray

### STEP 6. GENERAL UNIT OPERATION

If required, spray out any cold material in the unheated whip, then start spraying.

If drums are changed, enter the new fluid level and continue spraying. (refer to STEP 3).

If errors occur, correct the issue, press the RESET button, then the START button (refer to STEP 5).

When finished spraying, press the STOP button.

To power off the unit, rotate the power switch on the right side of the control module to the OFF position (indicated by the character "0").

## INTELLISPRAY OPERATION TIPS

The system should always be turned off during transportation.

Remove and position all hose from the hose rack before turning the system on. This avoids the possibility of overheating the hose.

Remove tight loops in the hose before pulling the hose into position to avoid hose kinking.

Straighten hose sections near modems to give the unit the best temperature feedback.

Do not drag the hose from the gun, whip, or modems. Use care when moving the hose to avoid damaging or snagging internal power cables.

All air must be purged from the wetted A-side module and hoses to avoid solidifying material in the lines.

Do not pull on hose sections not in line-of-sight to prevent tight loops and kinking.

Do not heat the hose without fluid to avoid damaging it and causing leaks.

Leave the hose under positive pressure when not in use to avoid reacting with the ambient environment.

If two or more IntelliSpray systems are used in proximity (<300 ft apart, either hose or proportioner), ensure

they are set to operate at different hose communication frequencies to avoid interference and/or cross-talk between systems.

Never operate the system "dry" unless performing a B-side air purge (see DISPLAY SCREENS "EXAMPLE 5-B SIDE AIR PURGE"). Dry system operation will damage the pumps.

Always check A and B drum levels at the start of the day or when changing drum(s), and enter the measured value in the Drum Level Widgets on the Spray Screen.

Always have fluid in the drums. If the transfer pump(s) run out of fluid, they can inject air into the supply hoses, IS30, and possibly distribution hoses. If this happens, the system must be purged of all air pockets from the transfer pump to the gun (see DISPLAY SCREENS "EXCHANGE SCREEN-USE"). Failure to purge air from the system can damage the system and cause off-ratio spraying.

When spraying is completed, stop the system before coiling up the hose on the rack (press stop on the display screen). This will avoid the possibility of accidental spraying for excessive leakage if the hose is damaged.

Do not operate the system with module covers removed unless performing diagnostics.

### CAUTION

System must be purged of air before spraying or recirculating material. Failure to do so can result in equipment failure.

### CAUTION

Remove all hose from the hose rack before starting the system. Excessive wraps of hose can result in overheating and damage to the hose.

This page intentionally left blank.



## DISPLAY SCREENS

### DISPLAY SCREENS—OVERVIEW

The IS30 Proportioner uses a 10.1 inch high resolution capacitive multi-touch color display for all user interaction.

The wide-angle display is mounted on the front of the Control Module in portrait mode, similar to how a user interfaces with a mobile phone. The display is designed for use in rugged industrial environments, is IP66 rated, and is visible in direct sunlight.

The display screens are highly intuitive, using text, icons, pop-up windows, widgets, and even hand-held bar-code scanners to provide system monitoring, control, setup, and diagnostics. If enabled, all screens can be accessed remotely via a web browser from any device connected to the internet.

See the "REMOTE ACCESS" chapter for more details on remote monitoring and control. As delivered, the IS30 is set to English language and SI units of measurement. Refer to the "LANGUAGES" chapter to change these settings.

DISPLAY SCREEN OVERVIEW	
Specification	IS30
Display	10.1" TFT LED
Resolution	1280 x 800 WXGA
Colors	16M
Brightness	500 Cd/m <sup>2</sup>
Touchscreen	True Glass Projected Capacitive, Multitouch
Operating Temperature	-20° to +60 °C
Protection Class	IP66 (front)

### IS30 DISPLAY SPECIFICATIONS

After the proportioner is powered on, the display will indicate that the system is booting up and performing internal hardware checks.

A rotating image of the Carlisle Fluid Technologies ST1 spray gun will be shown during startup. If hardware errors are encountered during boot-up, a popup window will appear with the associated error message (see the "TROUBLESHOOTING" chapter for error messages and diagnostics).

Within 30 - 60 seconds, the display will change to either the Spray Mode screen or the Exchange Mode screen. While the Spray Mode screen is the factory set startup screen, users can change this to Exchange Mode if desired (see DISPLAY SCREENS "SETTINGS SCREENS-DISPLAY SETTINGS").

The IS30 operates in one of two Modes: Spray Mode or Exchange Mode.

In spray mode, the system controls all heater zones (A and B preheaters and up to 4 independent hose heaters) and A and B pumps to deliver fluids to the gun at the specified setpoints on the spray screen.







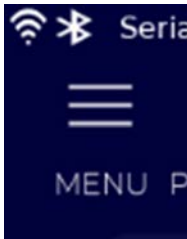

The ratio is always controlled to 1:1 (A:B by volume). **The ratio is adjustable using the Variable Ratio Key.**

### BOOTUP SCREEN



A pull-down menu icon is located in the top left corner of all display screens (similar to most mobile Apps). When this is pressed, a menu of all first-level screens is shown.

The following figure provides a summary description of each menu item and the page number in this manual for more information.

	<p>Close pull-down menu</p>	Section
<p>CLOSE</p>	<p>Close pull-down menu</p>	Section
 <p>SPRAY</p>	<p>Spray Mode (active mode)</p>	57
 <p>EXCHANGE</p>	<p>Exchange Mode (grayed out means not active)</p>	70
 <p>ALARM</p>	<p>Alarm Screen (current and historical warnings and errors)</p>	86
 <p>SYSTEM</p>	<p>System Status and Diagnostics (in submenus)</p>	91
 <p>SETTINGS</p>	<p>System Settings</p>	105
 <p>RECIPE</p>	<p>Recipes (for recalling, creating, saving, editing deleting recipes)</p>	128
 <p>REPORTS</p>	<p>Reports (in submenus)</p>	139
 <p>LANGUAGE</p>	<p>Languages (in submenus)                      Double arrows indicates submenus exist for these items</p>	151

### SPRAY SCREEN<sup>1</sup>–OVERVIEW

The Spray Screen is factory-set as the default start-up screen. Users can enter and adjust key operating settings via screen buttons, on-screen keyboard, pulldown menus, and pop-up windows. Previous user settings are retained when power is cycled. Pressure, Temperature, and Drum Widgets display current values, inputting setpoints, and other values.

NOTE: Pressure and temperature setpoint locations shown on the Spray Screen are at the end of the last distribution hose located at the smart end.

This makes sure that the IS30 delivers the most consistent performance regardless of material flow rates, viscosity, hose length, elevation changes, or environmental and other work conditions. A high level overview of the Spray Screen is shown below.

NOTICE

Temperatures and Pressures are measured at the last hose modem section.

1. Modes & Screens Access Menu
2. Pressure Widget
3. Temperature Widgets
4. Display & Enter System Operating Parameters
5. Drum Widgets
6. Screen Control System State

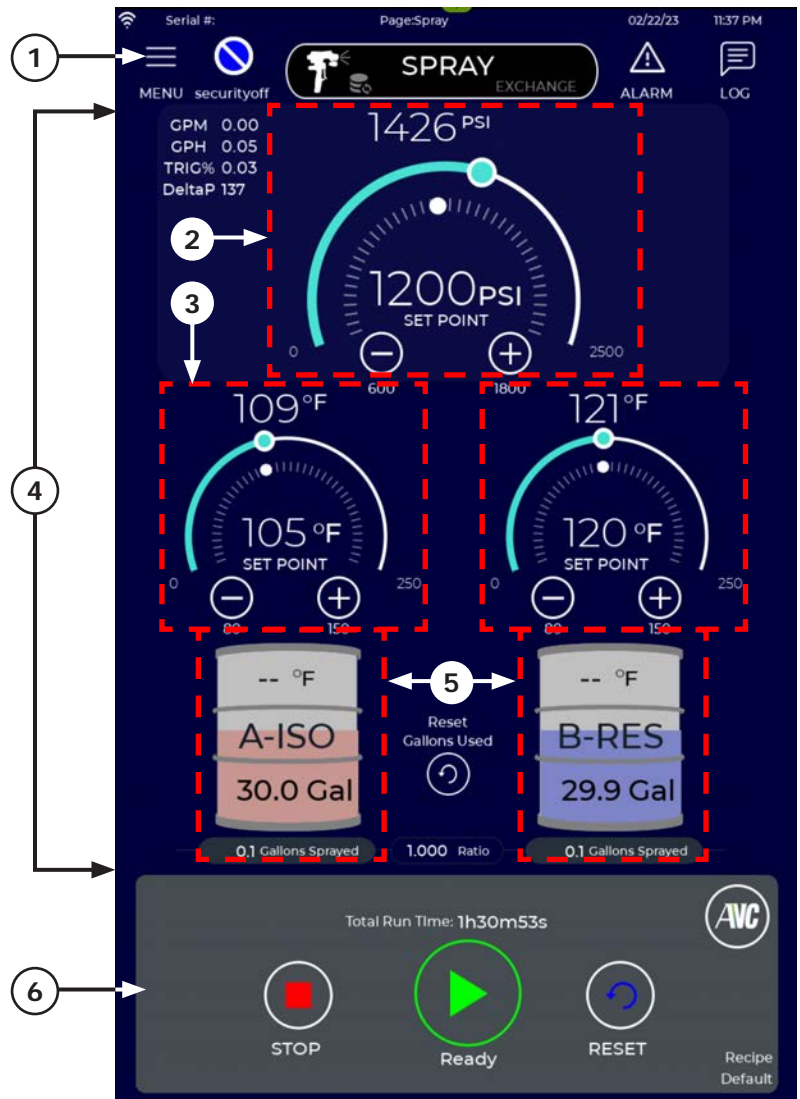

<sup>1</sup>Job logging and Security are disabled. See "SETTINGS SCREENS-SYSTEM STATUS" and "REPORTS-OVERVIEW" for more information on Job logging and Security.

**SPRAY SCREEN<sup>1</sup>—USER INFORMATION**

The Spray Screen displays current operating and system information to the user in easy to understand text and graphics. The following figure describes each information element provided to the user on the Spray Screen.

1. Remote Connection Established (if icon shown)
2. Real-Time Flow Rate
3. Average Flow rate
4. Trigger On %
5. Pressure Difference
6. Pressure
7. Pressure Setpoint
8. Minimum Setting
9. A-Temperature
10. A-Temperature Setpoint
11. Minimum Setting
12. Maximum Setting
13. A-Drum Temperature
14. A-Drum Fluid Level
15. A-Material Sprayed (since counter reset)
16. Real-Time Ratio A:B
17. Total "Ready" Time (since system was last started)
18. Serial Number
19. Current User (if Security is enabled)
20. Active Mode
21. Alarm Indicator (red if there is an active alarm and a dialog box appears with errors)
22. Current Date and Time
23. Gauge Icons (shown here to indicate the inlet compensation is enabled)
24. Maximum Setting
25. B-Temperature
26. B-Temperature Setpoint
27. Maximum Setting
28. Minimum Setting
29. B-Drum Temperature
30. B-Drum Fluid Level
31. B-Material Sprayed (since counter reset)
32. AVC™ Status (White=Off, Green=On)
33. Current Recipe
34. System State

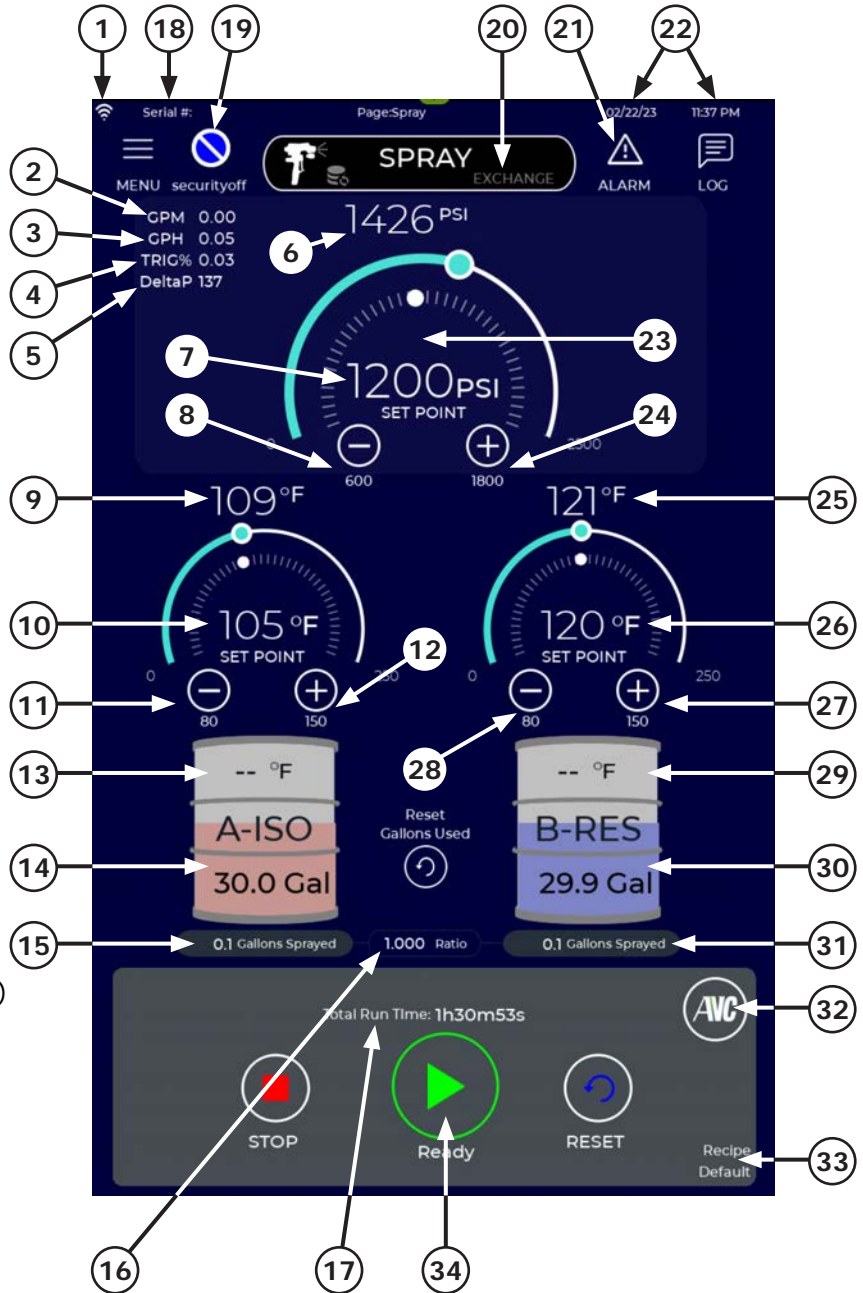

<sup>1</sup>Job logging and Security are disabled. See "SETTINGS SCREENS-SYSTEM STATUS" and "REPORTS-OVERVIEW" for more information on Job logging and Security.

## SPRAY SCREEN<sup>1</sup>—USER ACTIONS

The Spray Screen also contains dynamic fields for user input and actions. These are shown in the following figure.

1. Pull-Down Menu (see "DISPLAY SCREENS-OVERVIEW")
2. Home and Mode Select Button
3. Pressure Setpoint (press to decrease)
4. A-Temperature Setpoint (press to decrease)
5. A-Temperature Setpoint (press to increase)
6. A-Drum Pop-Up Widget (press to open)
7. Fluid Counter Rest (shown when "JOB REPORTING" is disabled)
8. System Stop (shuts off heaters and pumps)
9. System Start (initiates heating and pressurization)
10. System Reset (clear error condition)
11. AVC™ Button (press to toggle on/off)
12. B-Drum Pop-Up Widget (press to open)
13. B-Temperature Setpoint (press to decrease)
14. B-Temperature Setpoint (press to increase)
15. Pressure Setpoint (press to increase)
16. Log Buttons (see "REPORTS-JOB NOTES")
17. System Alarms (see "ALARM SCREEN-OVERVIEW")

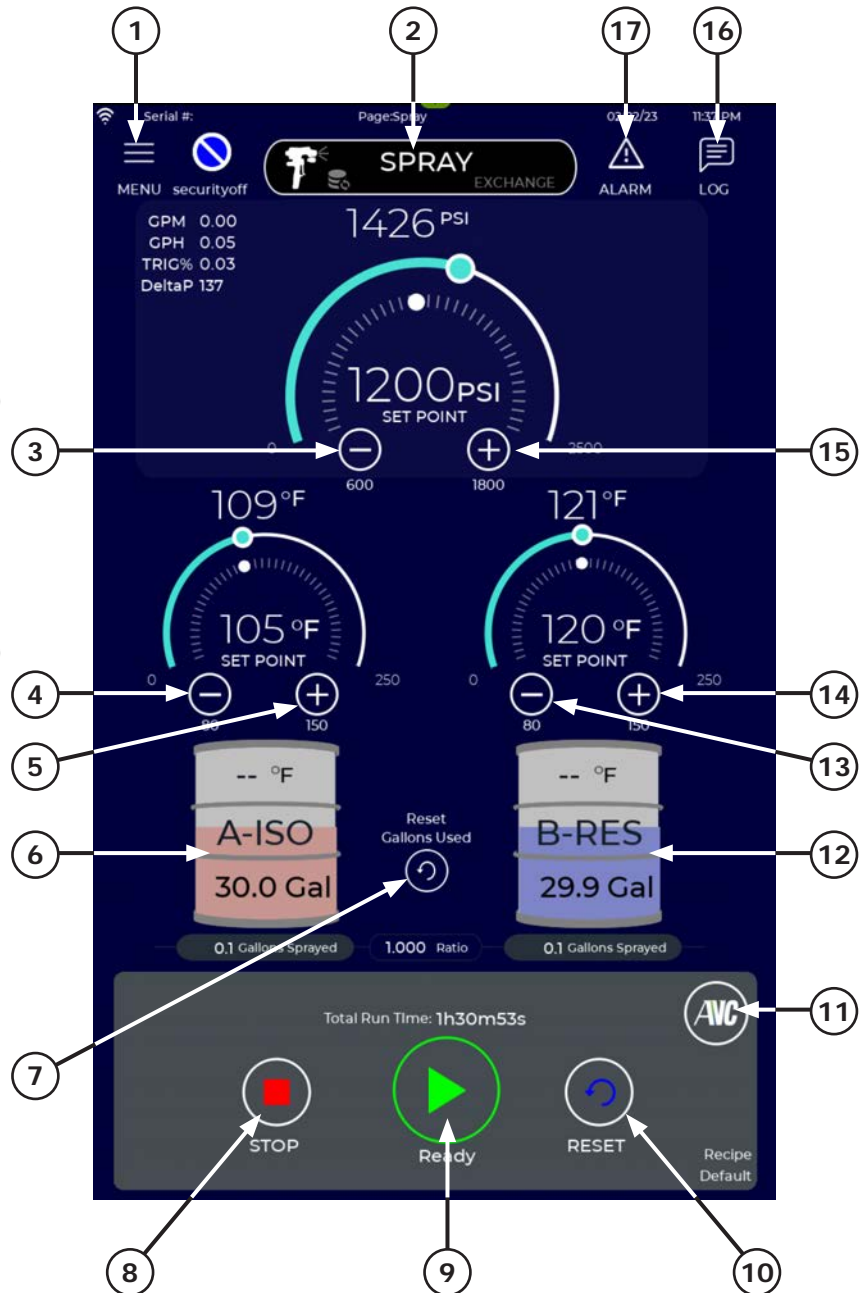

<sup>1</sup>Job logging and Security are disabled. See "SETTINGS SCREENS-SYSTEM STATUS" and "REPORTS-OVERVIEW" for more information on Job logging and Security.



**SPRAY SCREEN–USE**

The Spray Screen is the factory default startup screen. Users can change the startup screen to Exchange Mode if desired (see "SETTINGS SCREENS-DISPLAY SETTINGS").

The operator uses the Spray Screen to enter the pressure and temperature setpoints to be maintained at the beginning of the unheated whip (e.g., near the gun). This proximity to the gun assures that the Proportioner delivers the most consistent performance regardless of material viscosity, flow rates, hose length, or environmental conditions. Unlike many other

systems, there are no preheat temperature setpoints, static pressure controls, knobs, dials, buttons, or levers to operate. The only required settings are a single pressure and A and B temperatures, which are entered using on-screen buttons. If AVC™ is enabled only a single temperature setpoint is required (see DISPLAY SCREENS "SPRAY SCREEN-AUTOMATIC VISCOSITY COMPENSATION").

When using the Spray Screen, the following steps can be executed in any order.

**STEP 1. SET PRESSURE**

The pressure setpoint is retained from the last time the system was powered off. To decrease, press the down (negative) button.

Press the up (positive) button in the Pressure Widget to increase. Each press of the button increments pressure by 5 psi. Holding the button down increments pressure by 25 psi. The pressure setpoint value is displayed in the middle of the gauge.

The actual pressure value is shown above the gauge and by the moving dot and circular bar. The maximum and minimum settable pressure is shown below the setpoint buttons. The default maximum gauge range is 2500 psi.

These settings can be changed in the Recipe menus (see "RECIPES SCREEN-OVERVIEW").

**STEP 2. SET A & B TEMPERATURES**

The temperature setpoints are retained from the last time the system was powered off. To change the A or B temperature setpoint press the respective decrease (negative) or increase (positive) buttons in the A and/or B Temperature Widget. Each press of the button increments the temperature by 1°F. Holding the button down increments temperature by 3°F.

The temperature setpoint value is displayed in the middle of the gauge. The actual temperature value is shown above each gauge and graphically on the gauges by the moving dot and circular bar.

The maximum and minimum settable temperatures are shown below the setpoint buttons. The default maximum gauge range is 180°F. These settings can be changed in the Recipe menus (see "RECIPES SCREEN-OVERVIEW").



Press to decrease pressure

Press to increase pressure



Temperature setpoint (press to decrease)

Temperature setpoint (press to decrease)

**NOTICE**

Temperature and Pressure shown on the Spray screen are measured from the point right before the start of the unheated hose whip near the spray gun. If a user is accustomed to system operation control at the Proportioner, the user will need to set lower pressures by 1-3 psi per foot of hose. This is dependent on viscosity and flow rate.

### STEP 3. SET DRUM LEVELS

The A and B fluid levels are displayed in the Drum Widgets as both a numeric value and a moving colored level indicator. The system decrements the amount of material sprayed or purged if in Exchange Mode from the initial drum level entered by the user.

The drum outline will flash yellow when the fluid levels drop to the predefined warning value. The system shuts down when the fluid level drops to the predefined alarm level and displays an error message. The outline of the drum icon will flash red. The warning and alarm levels are factory set to 5 and 3 gallons, respectively, but can be changed by the user in the Settings screen (see "SETTING SCREENS-PREHEATERS").

The drum size default is 55 gallons. This value is used to scale the fluid level on the drum icon and can be set to other values in the Setting screen depending on supply container size (e.g., 15-gallon "pony" drums or 250-gallon "totes"). See "SETTING SCREENS-PREHEATERS" for information.

The user must enter the initial level to track and display the fluid remaining in each drum accurately. The user must enter the new level if additional material is added to the drum. The level can be reset anytime, even during spraying.

To enter the drum level, press anywhere on the drum icon (A or B), and a pop-up window appears for entering the amount of fluid in the drum.

When the pop-up window appears, press the drum level and enter the value using the on-screen keypad. Press the Enter button then the Save button on the pop-up window. The new value will be displayed on the drum and the graphical level indicator on the drum icon will be reset.

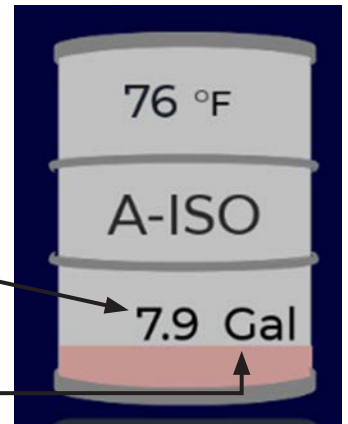

Drum level (value)

Drum level (graphical)

The previous entry value will be retained.

Press here to enter drum level.

If job reporting is enabled, more material information can be entered. See REPORTS.

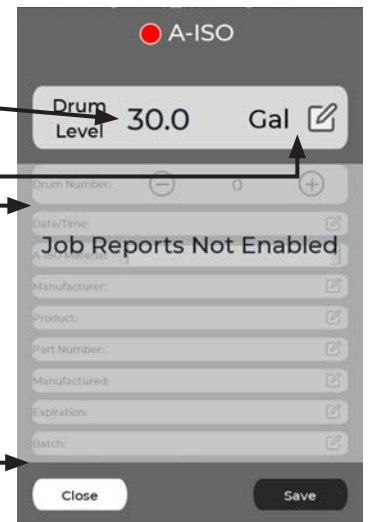

### CAUTION

Always verify A and B drum levels before the spray operation. Enter new values if needed. Do not let the drums empty of fluid during operation.

Change or refill drums before the fluid is empty as drum pumps can inject air into the Proportioner. Air that is injected into the Proportioner can damage it and cause off-ratio spray operation.

**STEP 4. CHECK FLUID VALVES**

Check that inlet fluid lines are pressurized and open, filter valves are open, and the recirculation valve is set to spray position.

**STEP 5. START THE PROPORTIONER**

Press the "START" button at the bottom of the spray screen. This will initiate the warmup sequence.

The center button will change from "START" to "WARMING UP," the button boundary will change from solid white to flashing green to indicate the system is warming up. Pressing the "STOP" button at any time turns off heaters and pumps.

If the IS30 detects a slow warmup, the "START" button will change to a flashing yellow "WARMUP BYPASS" button. Pressing the button will put the system in "READY" mode.

A gap between a hose temperature sensor and the internal hose heating element may cause this issue. Fluid spray operation will usually correct this issue by moving the heating element within the hose.

After the IntelliSpray Proportioner reaches the temperature setpoints (usually about 10 minutes from a cold start), the system will pressurize to the user setpoint pressure, and the "START" button will indicate the system is "READY" to spray. The spray operation can begin once the system is in a "READY" state.

**STEP 6. PAUSE OR STOP**

**NOTICE**

Do not start the spray operation until the button changes to the "READY" state.

When finished spraying, or if you are taking an extended work break, press the "STOP" button. This removes power from the heaters and pumps. To restart the system, press the start button again.

**CAUTION**

When the system is in the STOP mode or the Proportioner is turned off, the A and B fluids in the Proportioner and Hoses will be at higher temperatures and pressures. This condition can cause personal injury or property damage.



Spray (Gun) Position

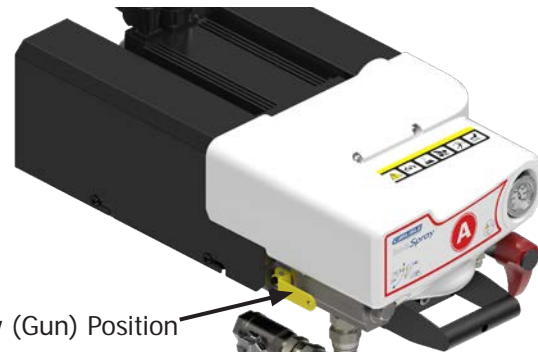

Spray (Gun) Position

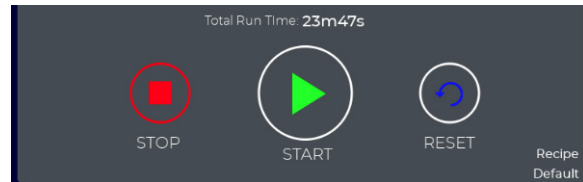

Press to Start System



Indicates system is warming up

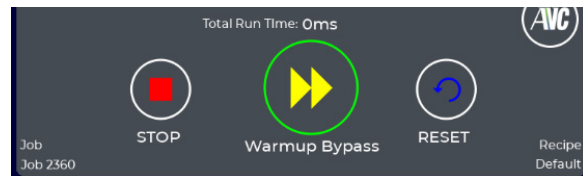

Indicates system is warming up



Indicates system is ready to spray



### SPRAY SCREEN—OTHER FUNCTIONS

The Spray Screen contains other information and functions that may be helpful to the user.

#### DRUM TEMPERATURE

In addition to indicating the remaining fluid amount, each Drum Widget shows the inlet fluid temperature. This is sensed at the inlet to the proportioner and indicates drum temperature when the material is flowing (e.g., during spraying, purging, or recirculating). The drum temperature will only be displayed after a short period of sustained flow. This temperature can be compared to the material manufacturer's acceptable fluid temperature range recommendations. The proportioner can be used to independently preheat A and B fluids using Exchange Mode (see "EXAMPLE 4-PREHEAT B DRUM MATERIAL").

#### FLUID COUNTER

The proportioner continuously monitors fluid consumption and displays the amount under each drum icon. The total amount used is the sum of the A and B values shown on the screen. These fluid counters can be reset to 0 (zero) by pressing the Reset Gallons Used button.

#### FLUID

The real-time fluid ratio (A/B) is also shown on the on the Spray Screen and updated every second.

#### FLOW RATE AND TRIGGER %

The real-time total flow rate (A+B) is shown in the upper left corner of the Spray Screen, along with the output per hour since the system was in a Run state.

Trigger % is also shown, which measures the total time fluid has been sprayed divided by the total time the system has been in the Run state since the last power cycle.

Higher trigger % values generally indicate higher sprayer productivity. Higher trigger % values can also improve material yield.

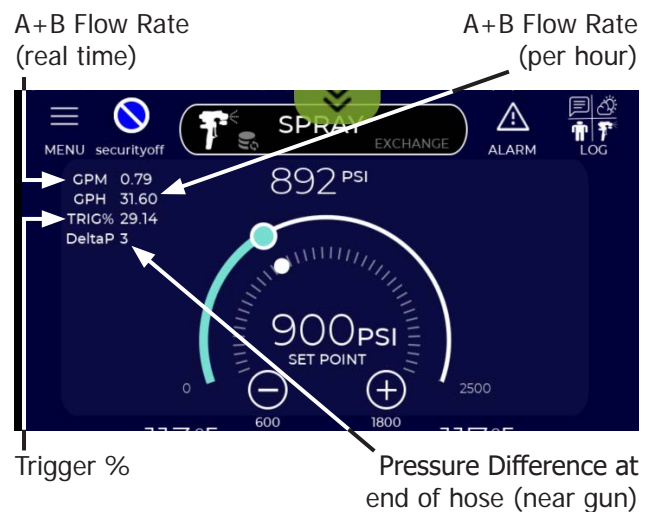
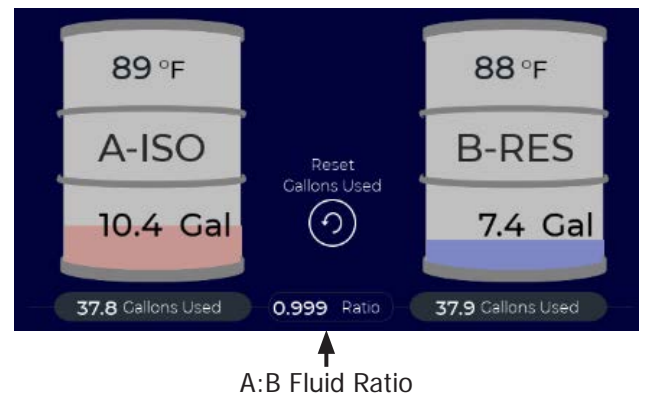
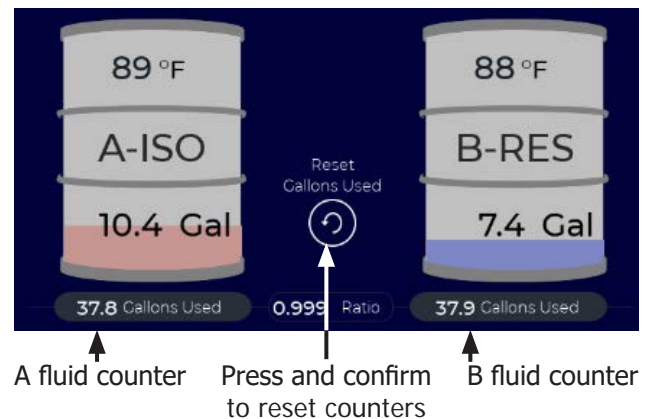
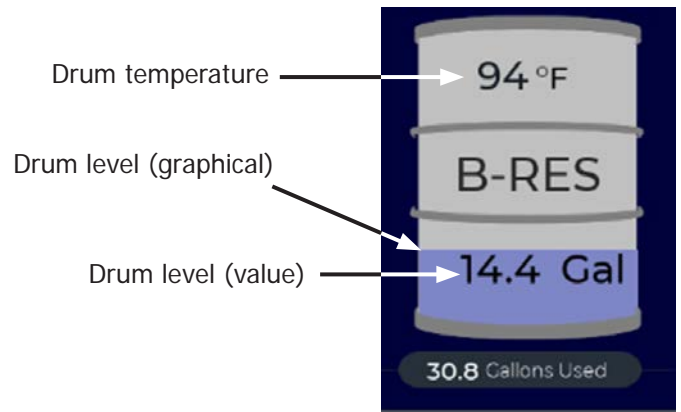

**ALARMS**

A red alarm icon and a dialogue box in the upper right section of the Spray Screen indicate active alarms.

The Alarm icon is white when there are no active Alarms. Alarms can be either Warnings or Errors.

Warning Alarms do not stop the system but must be addressed before they create an Error condition. Warnings are indicated by a Yellow Alarm Icon and a dialog box.

Error Alarms are conditions that automatically "STOP" the proportioner. The proportioner will remain in the "STOP" state until the error is resolved and the "RESET" button is pressed. All alarms provide possible causes and recommended actions. Pressing on the Alarm Icon will open the Alarm Screen (see "ALARM SCREEN" in this manual for more information).

In the example shown on the right, the A Drum level drops below the error limit level, causing the system to "STOP" and the alarm to activate. Additionally, the corresponding material icon will flash red.



**RESET**

Once the source of the error is found and addressed, the user must press the "RESET" button at the bottom of the screen before the "START" button is pressed to continue the spray operation.

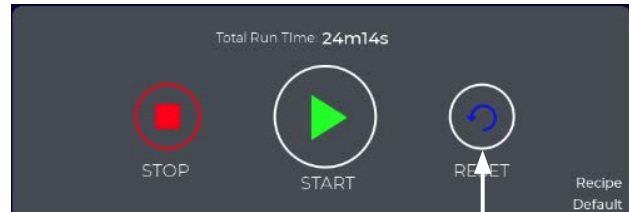

Press "RESET" to clear alarm before restarting system

**PREHEATER TEMPERATURE OFFSET**

In some cases, running the A and/or B preheaters at a temperature offset from the setpoint may be desirable.

Most often, this is used when the viscosity of the B fluid is very low (as in some open-cell materials). This can reduce the efficiency of the gear pumps or even cause premature wear of the pump bearings. In this case, keep the temperature of the B material cool, as it will result in a higher viscosity in the gear pumps.

The hose heaters may have to work harder to elevate the temperature to the set point, but that is not a problem in most cases. A Preheater offset can be entered in the active Recipe (see "RECIPE SCREENS"). If a Preheater offset is entered, it will show in the temperature widget below.

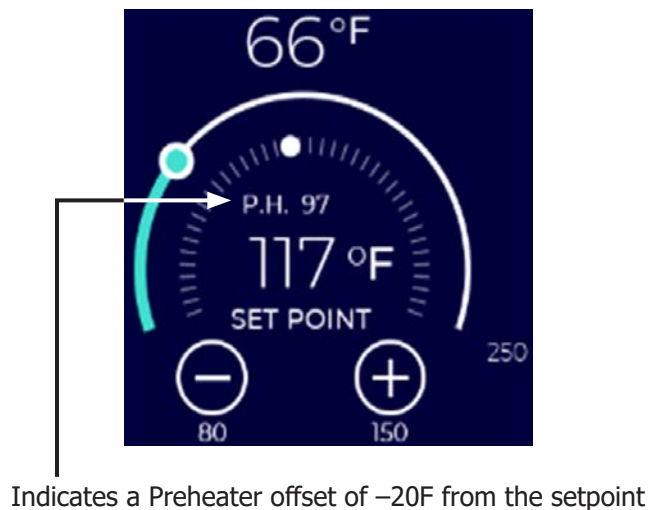

Indicates a Preheater offset of -20F from the setpoint

### ALARM DETAILS

Users can see more information on active and past errors or warnings by pressing the alarm icon or message window. Refer to "ALARM SCREENS" for more information on the Alarm Screen.



Press to see more information on alarm

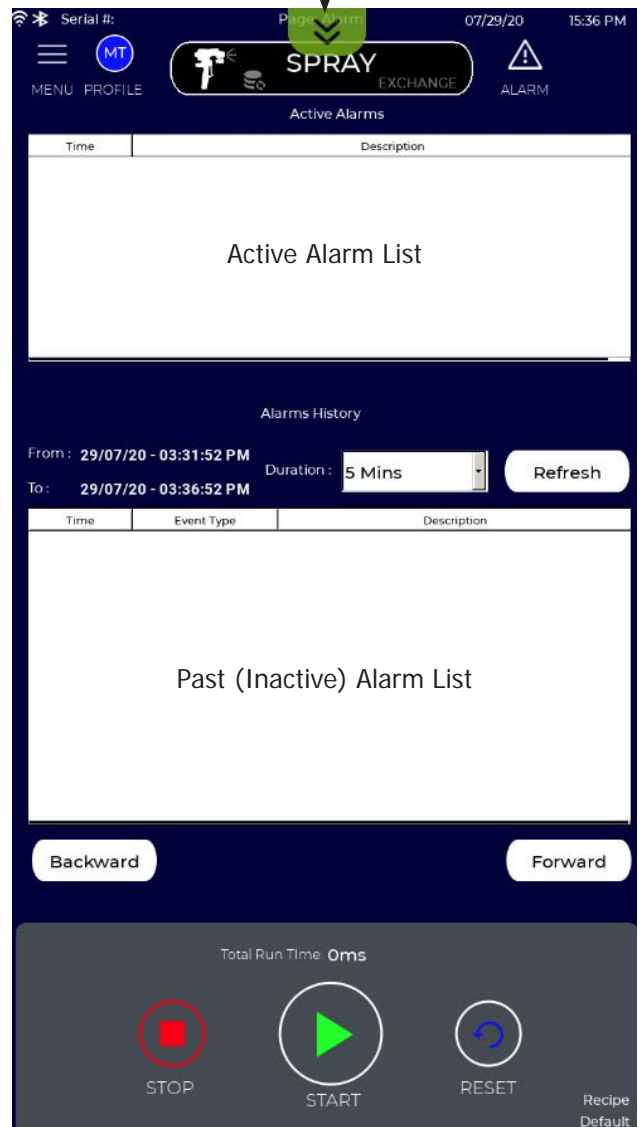

### INLET COMPENSATION

When Inlet Compensation is enabled, a small dial icon is shown within the Pressure Widget (as shown).

Inlet Compensation is enabled from the factory but can be disabled in the Recipe Pressure Table (see "RECIPE SCREENS").

"SPRAY SCREEN-AUTOMATIC INLET COMPENSATION" provides more information about the Automatic Inlet Compensation mode.

When Inlet Compensation is enabled in the active Recipe, the IntelliSpray proportioner will automatically prevent inlet flow starvation. This prevents fluid cavitation, off-ratio issues, and pump damage.

This feature may be required if drum temperatures are too low, material viscosities are too high, transfer pumps are undersized, lack adequate air pressure or flow, or leak.

Reducing the pressure setpoint and/or gun chamber/tip size can also compensate for material starvation.

Icon indicates Inlet Compensation is enabled.

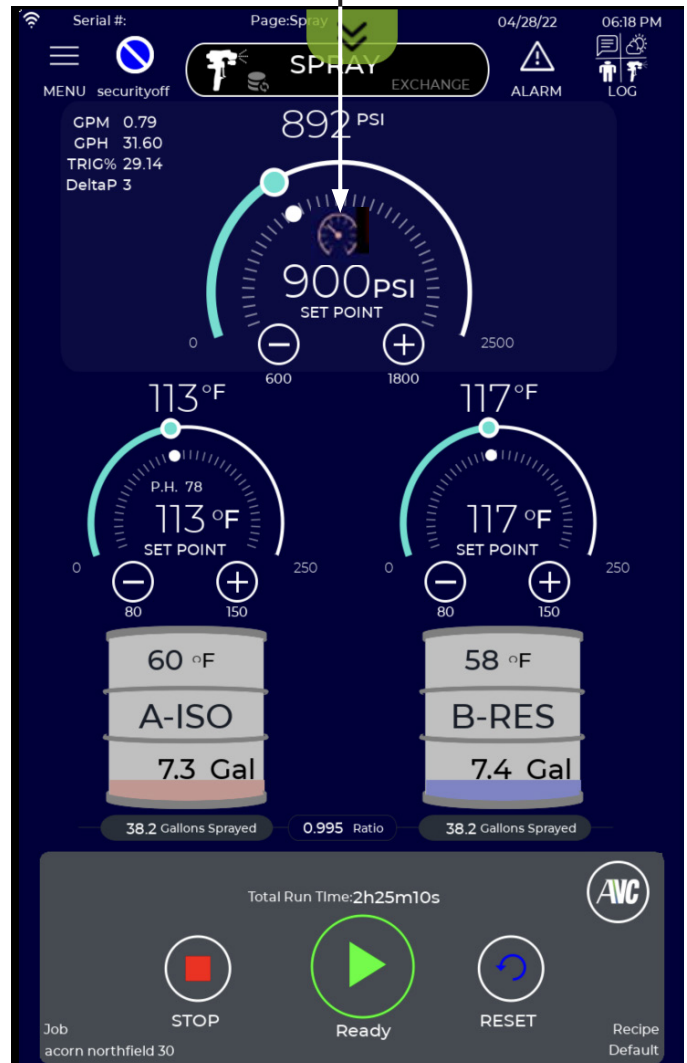

## AUTOMATIC VISCOSITY COMPENSATION (AVC™)

IS30 Proportioners are equipped with Automatic Viscosity Control (AVC™). When enabled, AVC continuously adjusts fluid temperatures throughout the system to minimize viscosity differences between the A (Isocyanate) and B (Resin) materials.

At the same time, AVC maintains the user-defined fluid output mix temperature and pressure. This results in better pressure balance at the spray gun, a more consistent spray pattern, improved impingement mixing, and reduced potential for fluid cross-over in the spray gun.

AVC can be enabled or disabled from the Spray screen at any time during operation by pressing the "AVC" button next to the "RESET" button.

When disabled (AVC OFF), the "AVC™" button will be white, and both A and B temperature widgets will be visible. This is shown in the figure to the left.

When enabled (AVC ON), the "AVC" button outline will be green, and the A and B temperature widgets will collapse to a single temperature widget, as shown below (right).

This widget now shows the average fluid "mix" temperature of the A and B fluids at the end of the distribution hose (near the spray gun). When AVC is "ON," the user needs to set just one temperature rather than two, which now represents the mixed temperature of the fluids.

The proportioner manages the preheaters and hose heaters to provide this mixed temperature while minimizing viscosity and pressure differences between the two fluids throughout the system. The pressure setpoint and control are unaffected.

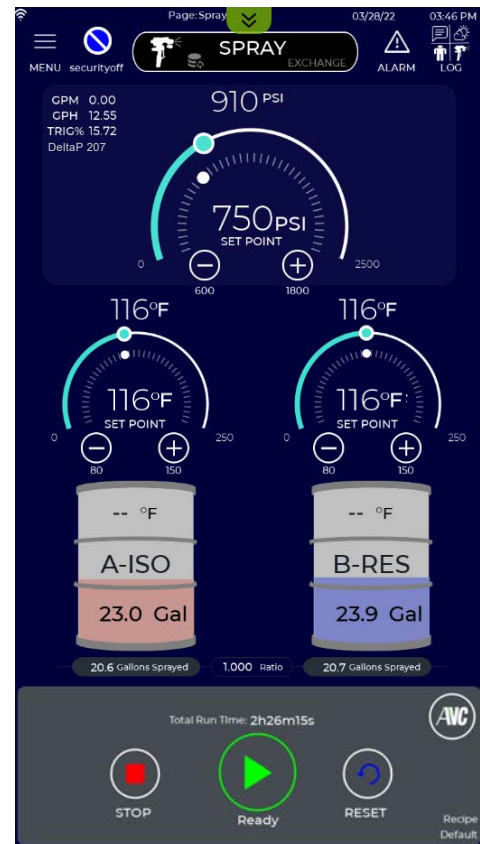

AVC™ OFF

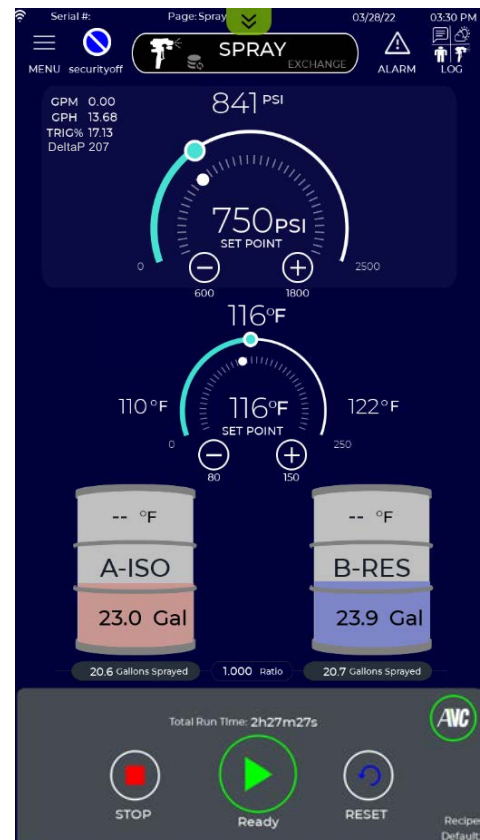

AVC™ ON



When AVC™ is active, the dynamic pressure difference (DeltaP) is shown in the upper left portion of the Spray Screen. DeltaP is the actual pressure difference between the A and B fluids at the end of the distribution hose (nearest the gun).

The average mix temperature is shown in the temperature widget, and the temperature setpoints of the A and B fluids are shown on the left and right of the temperature widget. AVC determines these setpoints.

Press the + or - buttons under the single temperature widget to increase or decrease the fluid mix temperature. AVC will automatically adjust the temperatures of A and B materials while maintaining the specified mix temperature. The maximum allowable difference between A and B temperatures is 50F but can be reduced in the Recipes Screen.

When the user disables AVC (by pressing the "AVC" button), both A and B temperature widgets will reappear, showing the temperature settings determined by AVC.

Users can return to AVC (or disable it) at any time while spraying by pressing the "AVC" button.

1. Dynamic Pressure Difference (between A and B fluids at the end of the distribution hose).
2. Mix Fluid Temperature (actual).
3. User Temperature Setpoint (of the fluid "mix").
4. A Side Temperature Setpoint (determined by AVC).
5. B Side Temperature Setpoint (determined by AVC).
6. AVC Enabled (green border w/one temperature widget).

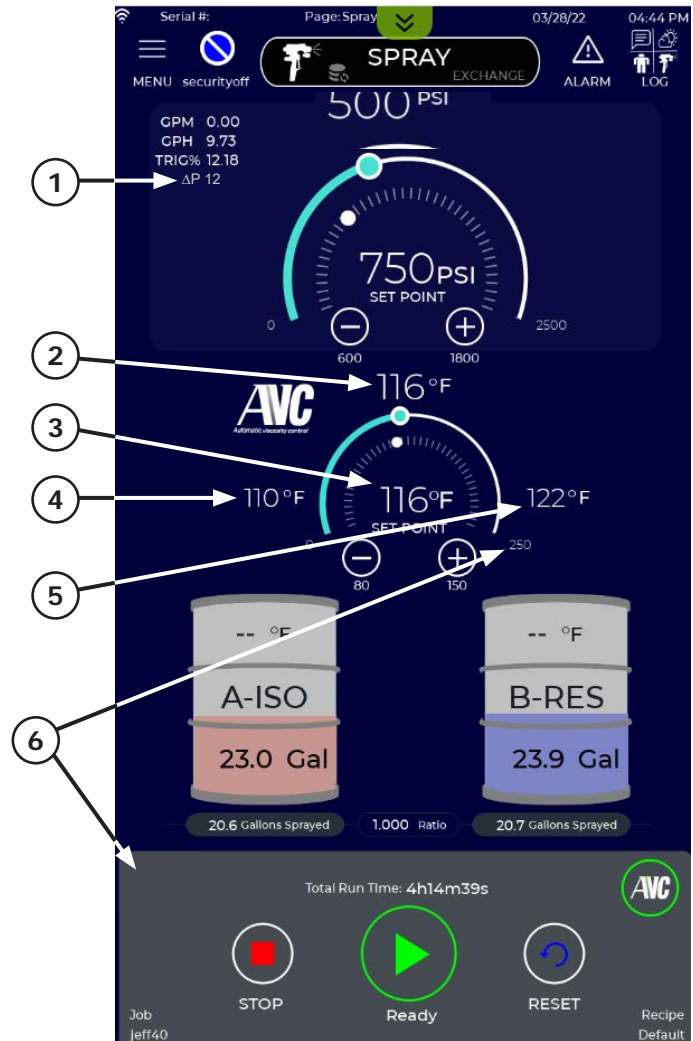



### AUTOMATIC INLET COMPENSATION (AIC)

IS30 proportioners are equipped with Automatic Inlet Compensation (AIC). AIC continuously monitors inlet fluid pressures and adjusts A and/or B gear pump speed as needed to prevent fluid cavitation in the supply lines or low-pressure manifold of the proportioner.

Fluid cavitation occurs when transfer pumps cannot maintain adequate flow to the proportioner. Cavitation creates gaseous bubbles (frothing) in the fluid that can damage gear pumps, cause off-ratio spraying, and create cross-overs at the spray gun.

AIC is enabled by default but can be disabled in the active Recipe (see "RECIPE SCREENS"). AIC becomes active when any of the inlet manifold pressure sensors detect persistent transfer pump pressure conditions below 60 psi. When AIC is active, small gauge icons will appear inside the Pressure Widget on the Spray screen. A red gauge icon indicates which side (left = A, right = B) low inlet pressure is sensed on.

When AIC is active, the user will notice a slight pulsation or reduction in output. The fluid ratio will not be affected. If AIC is disabled in the active Recipe, the system will display a low-pressure alarm and move to a Stop state when the A or B pressure drops below 25 psi (1.7 bar). AIC is intended to allow users to keep spraying until the cause(s) of low inlet pressure can be addressed. A user can also lower the proportioner pressure setpoint and/or spray gun chamber size to reduce the demands on the transfer pumps. However, this will not address the root cause(s) of low inlet pressure. The table provides several possible causes and actions related to low inlet pressure.

Gauge icons indicate AIC is active.



AIC Active

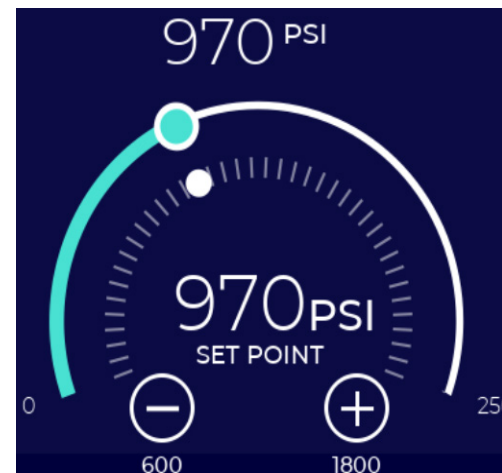

AIC Inactive

### AUTOMATIC INLET COMPENSATION ALARMS

Possible Causes for Low Inlet Pressure	Actions
Undersized transfer pumps	Install transfer pumps that match proportioner flow rate.
Fluid is too cold (resulting in higher viscosity)	Make sure fluid supply is at recommended temperature.
Low transfer pump air pressure	Raise air pressure.
Low transfer pump air flow	Increase flow rate (larger compressor, larger diameter air lines, eliminate air line restrictions).
High-pressure loss between transfer pump and proportioner	Increase fluid supply hose diameter, reduce length, eliminate any flow restrictions.
Leaking seals in transfer pump	Repair transfer pump.

## EXCHANGE SCREEN—OVERVIEW

When in Exchange Mode, the IS30 proportioner allows the user to independently Purge or Recirculate either A and/or B fluids. In this manual, the definition and difference between Purge and Recirculate functions are as follows:

**Purge:** Fluid **is not** returned to the supply drums. Drum level counters are decremented by the amount of fluid purged. Used when the operator needs to push material through the system. Commonly used during changeover between different materials. Also used to purge old material from proportioner and/or hoses and/or to flush for service or storage.

**Recirculate:** Fluid **is** returned to the supply drums. Drum level counters are not decremented by the amount of fluid recirculated. Most often used to preheat and/or mix Open Cell resins (B-side).

Fluid may be purged or recirculated from the proportioner or the end of the hoses. The proportioner includes fittings for attaching purge or recirculation hoses to the fluid modules (see "FLUID MODULE").

Carlisle Fluid Technologies provides a recirculation manifold with all ST1™ Spray Gun kits that can be attached to the hose manifold for recirculating from the hose end. Many users hang the hose manifold over a drum bung opening when recirculating or over a waste bucket when purging.

The user must exit (STOP) Spray Mode to activate Exchange Mode. If the Spray Mode is active, the system will require the user to press the Stop button before Exchange Mode can be entered.

The user can activate EXCHANGE mode by selecting the menu item or pressing the "MODE" button at the top of the screen as shown below.

1. Press "MODE" Button (toggles to Exchange Mode).
2. Press Exchange Mode (shown in pull-down menu).

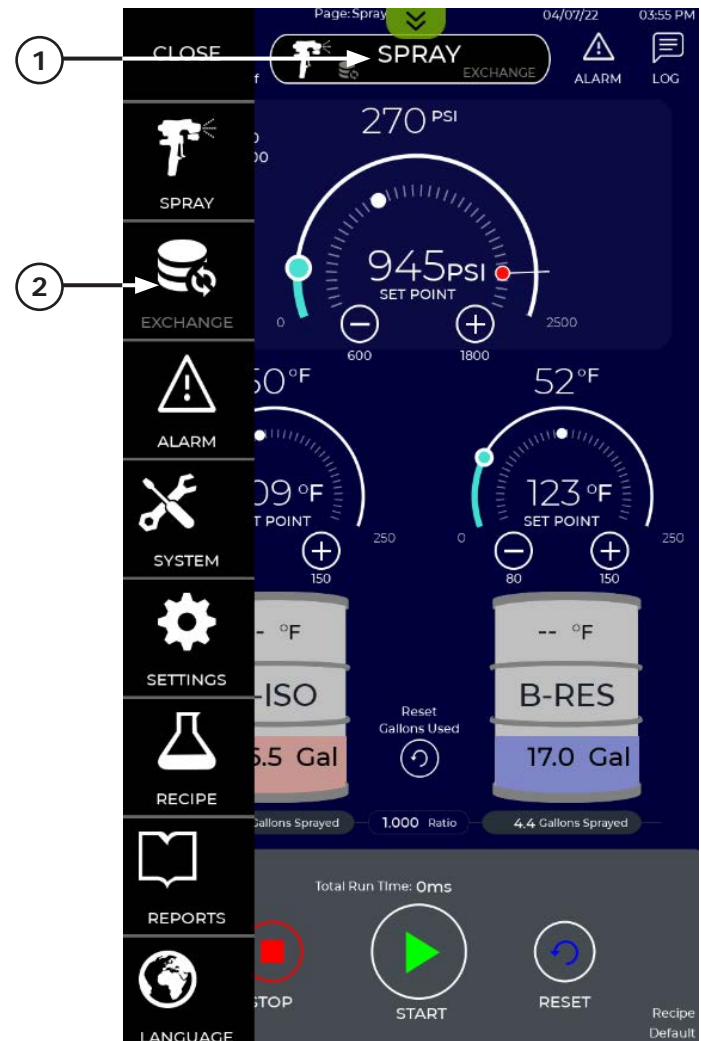

**EXCHANGE SCREEN–USE**

Before starting fluid exchange the user must set the following parameters:

**Function:** Purge or Recirculate

**Material:** A-ISO, B-RES, A-ISO and B-RES (both)

**Fluid Heating:** None, Preheat, Hose, Preheat and Hose (both)

**Method:** Manual, Time, Amount, Temperature

These parameters are selected using the pull down menus on the Exchange Screen.

The Exchange Screen is context sensitive and will adapt to the specific parameters selected.

All Exchange parameters are retained from the last time entered.

All possible parameter selections are shown below.

Pressing on the desired parameter selects it and indicates the selection with a check mark.

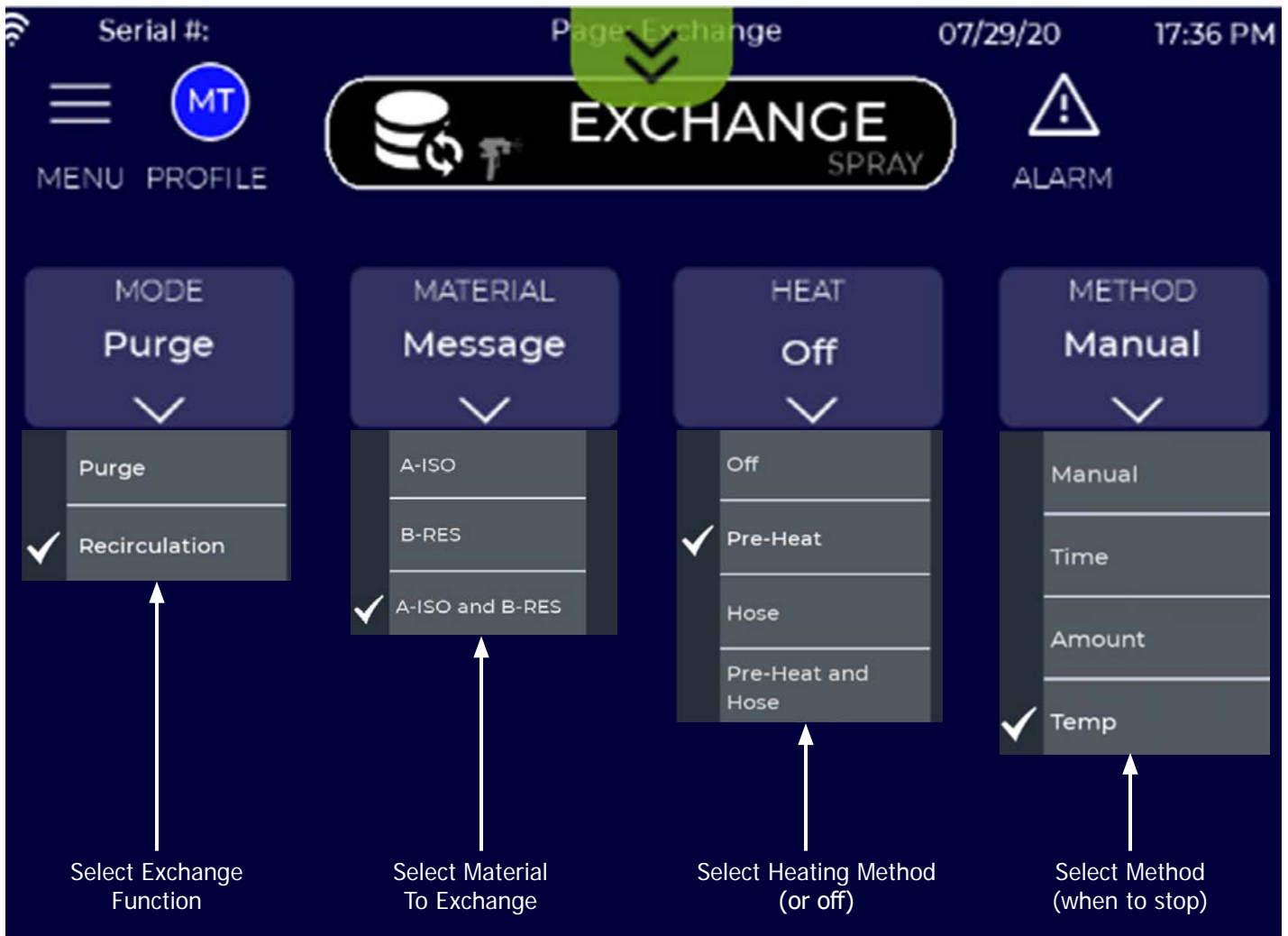

Prior to starting fluid Exchange (Purge or Recirculation), the following parameters must be selected. Parameter settings are retained so the user may not have to select again if performing the same Exchange operation.

**STEP 1. SELECT FUNCTION**

Select desired function **Purge** or **Recirculate**.

**STEP 2. SELECT MATERIAL**

Select **A-ISO**, **B-RES**, or **A-ISO and B-RES** (both).

**STEP 3. SELECT FLUID HEATING**

This selection is dependent on the user’s intent. If preheating a fluid through the proportioner (and not the hoses) the user would select **Preheat**. If they wish to only use hose heaters, they would select **Hose**. If the user wants to activate both preheaters and hose heaters, they would through select **Preheat and Hose**.

**⚠ WARNING**

Do not purge the proportioner or hoses with a flammable or oxidizing gas or liquid. Explosion and/or fire may result with significant injuries, loss of life, and property damage.

**⚠ CAUTION**

Air purge must not be used on the A (ISO) side. This will cause the ISO to harden in the system fluid passages and hoses.

**⚠ CAUTION**

Do not activate heat when the system is dry. This will cause the heater elements to fail and can cause a fire.

Be sure the preheaters and hoses are full of fluid before the system is started in Spray of Exchange mode.

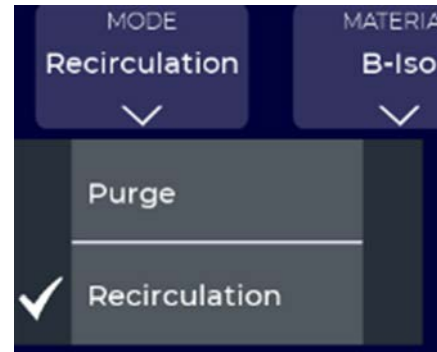

Select Function



Select Material

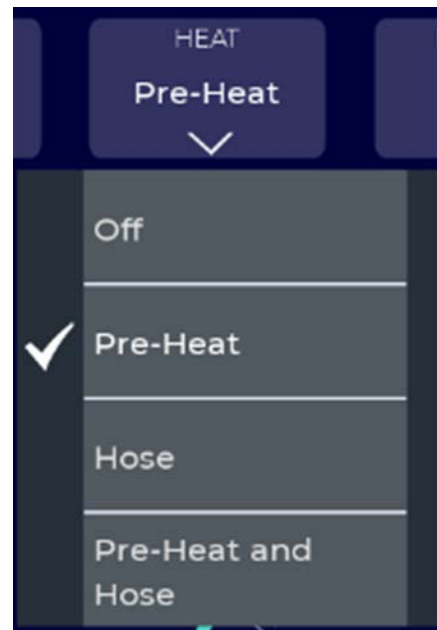

Select Fluid Heating

### STEP 4. SELECT METHOD

The proportioner allows the user to operate Exchange functions (Purge or Recirculate) manually. In addition, the user can select a Method parameter that will automatically stop the Exchange action when completed. The Method options are shown described and below.

The proportioner configures the Exchange screen based on selected parameters. This is shown in the examples on the following pages.

1. MANUAL: Manually starts/stops the Fluid Exchange.
2. TIME: Fluid Exchange continues for a user-defined amount of fluid.
3. AMOUNT: Fluid Exchange continues for a user-defined fluid volume.
4. TEMP: Fluid Exchange continues until fluid in drum reaches a user-defined set temperature (user input).

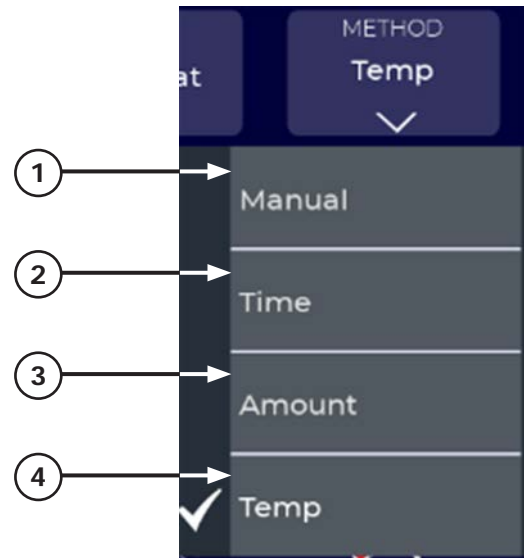

### STEP 5. SELECT MOTOR (JOG) SPEED

In Exchange mode the user must specify motor speed (also known as jog speed). The user sets the motor speed from 0% to 100% using the - and + buttons above the drum icons. Always start at a motor speed below 10% as higher speeds may result in an overpressure error. If the user is purging with compressed air on the B-side, motor speeds should be limited to 5% or less.

Instructions for performing an Air Purge are shown in "EXAMPLE 5-B SIDE AIR PURGE". Air purge should never be used on the A-side, as it could cause ISO to harden in the fluid passages and hoses. Fluid flow rate and pump pressure are indicated below the motor speed control buttons. The user can adjust motor speed to achieve a reasonable flow rate while keeping pressure below the maximum pressure setting.

See "RECIPE SCREENS" to set system maximum pressure). Motor speed can be adjusted while the motor is running.

5. Decrease Speed (press to change).
6. Increase Speed (press to change).
7. Flow Rate
8. Pump Pressure
9. Motor Speed

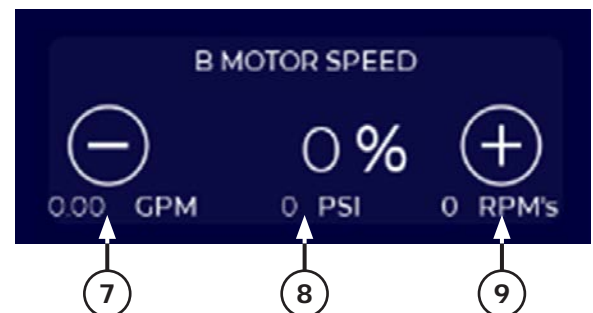
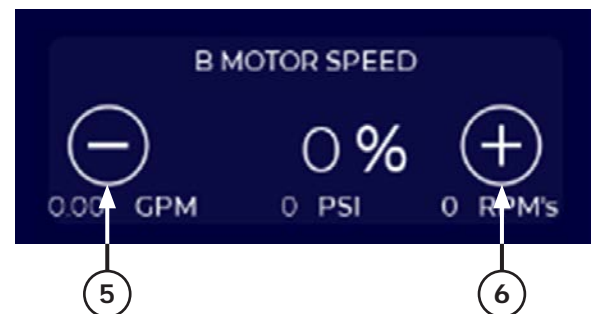

## NOTICE

Always start fluid Exchange at a motor speed below 10%. Higher motor speeds can result in an overpressure error. In Exchange mode it is best to start slow and then increase motor speed.



**STEP 6. EXAMINE FLUID LINES**

For the fluid(s) to be Exchanged (purged or recirculated) check to be sure:

- Supply pumps are at pressure
- Supply valves are open
- Filter valve on the proportioner is open
- Recirculation valve on the proportioner is the proper position (gun or drum) depending on intent.

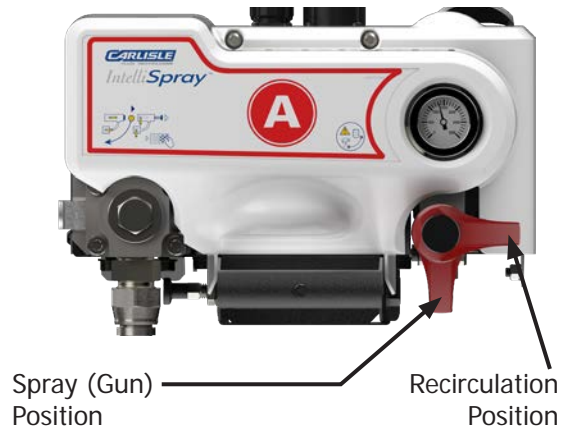

**STEP 7. START FLUID EXCHANGE**

Press the Start button to begin fluid exchange.

**STEP 8. ADJUST MOTOR SPEED**

Motor speed can be adjusted "on the fly" by pressing the - and + buttons above the drum icons. While higher jog speeds reduce the Exchange time, they can also cause an overpressure situation and/or cause material cavitation in the pump and possible pump damage. Most Exchange functions can be operated at 50% or lower motor speed settings.

Note that the real-time fluid flow rate, pump pressure, and motor RPM values are shown below the motor speed.

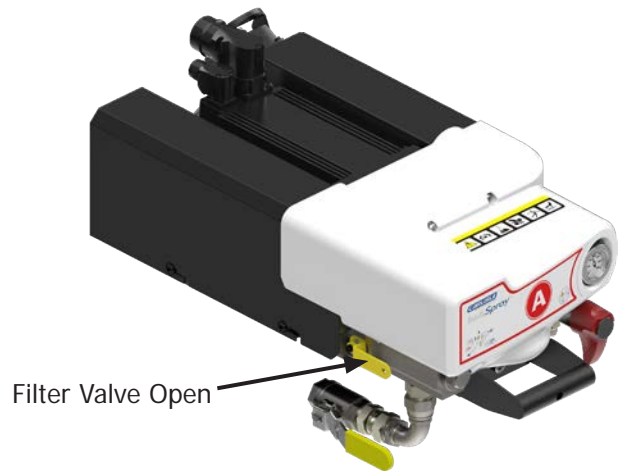

IS30 Fluid Valve Settings

**STEP 9. STOP FLUID EXCHANGE**

The user can press the Stop button at any time to stop fluid exchange. Otherwise the system will automatically stop if one of the following Methods is selected:

- **Time:** The system will stop when the specified time duration is complete.
- **Temperature:** The system will stop when the inlet fluid temperature reached the specified temperature.
- **Amount:** The system will stop when the specified amount of fluid is purged or recirculation.

The IS30 Exchange Mode has the ability to independently purge, recirculate, and heat A and B fluids. Its capabilities are extensive and intuitive. To help you become familiar with these capabilities, the following pages provide several examples.

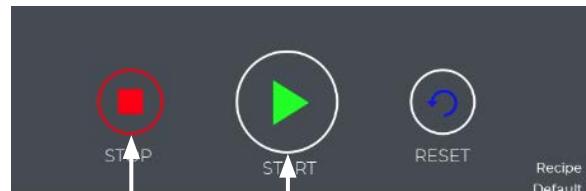

Press to stop Fluid Exchange

Press to start fluid Exchange

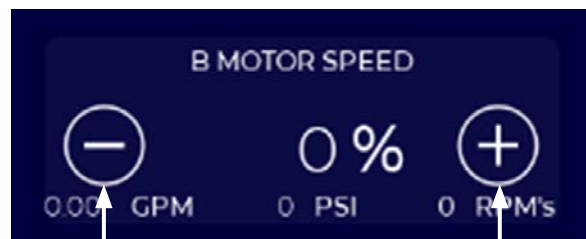

Press to decrease speed

Press to increase speed

**NOTICE**

Always start fluid Exchange at a motor speed below 10% as higher speeds may result in an overpressure error. In Exchange mode it is best to start slow and then increase motor speed.



## EXAMPLE 1—INITIAL SYSTEM BLEED

When the proportioner and/or hoses are installed, an initial system bleed is required to completely replace air with fluid in the supply hoses, proportioner, and distribution hoses. If air is introduced to the system (e.g. running the drum pump dry) the same procedure must be performed.

### STEP 1. SYSTEM MODE

Be sure the system is in STOP state as shown.

#### ⚠ WARNING

Fluid in hoses and proportioner may be under high pressure. System must be depressurized prior to performing any service function.

### STEP 2. SUPPLY LINES AND HOSE

Make sure that the supply lines, recirculation hoses, and distribution hoses are correctly connected.

### STEP 3. ANALOG PRESSURE GAUGE

Make sure the analog pressure gauge on the fluid module is bled. Relieve pressure by turning the outlet valve to the recirculation position. Once pressure is relieved, turn the outlet valve back to the gun position.

### STEP 4. FILTER VALVES

Set filter valve (4a) to open position (horizontal). Set the recirculation valve (4b) to spray position (pointed down).

### STEP 5. B SIDE PUMP

Activate the B-side transfer pump.

### STEP 6. HOSE MANIFOLD

Remove the spray gun from the hose manifold. Secure or hold the manifold over a waste container and open the B-side material control valve to catch fluid. Fluid may begin flowing out of the manifold at this point. This is acceptable.

### STEP 7. EXCHANGE MODE

After selecting Exchange Mode from the main menu:

7a. Select **Purge** from the "FUNCTION" menu.

7b. Select **B-RES** from the "MATERIAL" menu.

7c. Select **Off** from the "HEAT" menu.

7d. Select **Manual** from the "METHOD" menu.

#### ⚠ WARNING

Do not activate the heating mode when air or gas is present in the Proportioner or Hoses. This can cause the heater elements to fail and can create a fire hazard.

If air is not removed from the system properly, the gear pumps, preheaters, and/or hose heaters can be damaged. Air pockets can also create off-ratio conditions.

In this example the operation is shown for the B-side.

The same procedure would be used for the A-side.

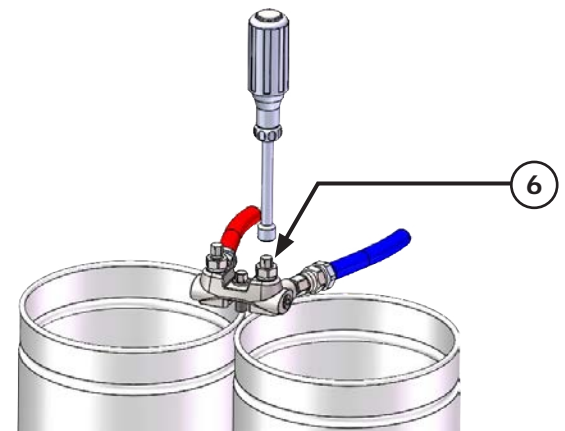
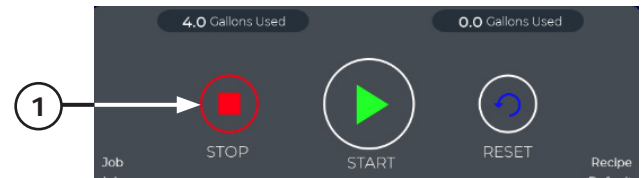

**STEP 8. SET B MOTOR SPEED**

Set B motor speed to 0% by pressing the — button in the Motor Speed Widget.

**STEP 9. SYSTEM MODE**

Press the "START" button to turn on the B Motor.

**STEP 10. INCREASE B MOTOR SPEED**

Increase B motor speed by pressing the + button in the Motor Speed Widget.

Motor speeds should be limited to 5% or less until fluid has filled the Fluid Modules to avoid damage to the pump bearings and internal surfaces.

Once pressure starts to build motor speed can be gradually increased but should remain below 50% until distribution hoses are filled.

**STEP 11. FLUID FLOW**

Press the STOP button when a steady stream of fluid flows from the manifold for at least 30 seconds and all air has been replaced with fluid.

**STEP 12. B SIDE MATERIAL CONTROL**

Close the B-side material control valve on the gun manifold.

**STEP 13. A SIDE**

Repeat the process for the A-side if required.

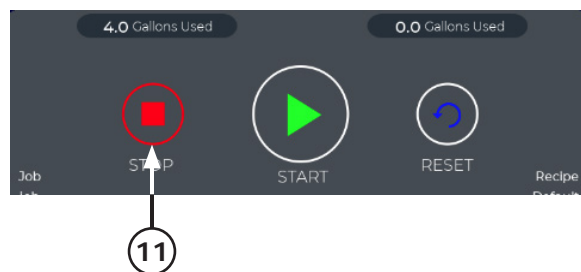
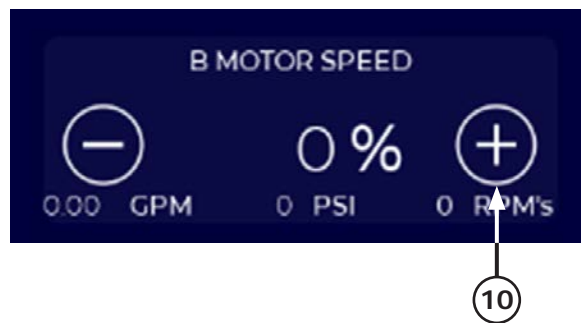
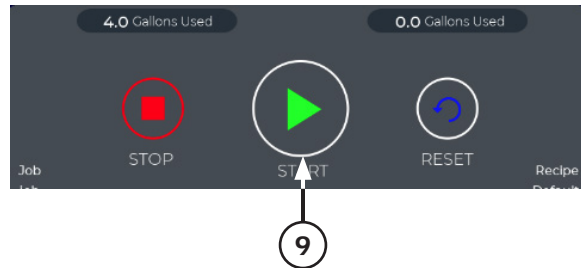
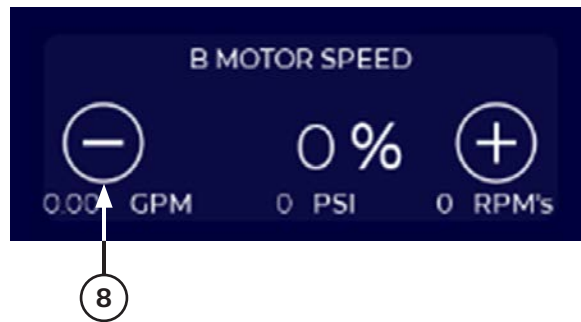
**! WARNING**

Never run gear pumps faster than 5% speed in Exchange Mode when dry. Do not run for more than 10 seconds when dry at this speed. Presence of fluid in the pump is essential to protect bearings and seals.

## EXAMPLE 2—A SIDE MANUAL PURGE

In this example old A-side material is purged through the entire system with new A material. Since the material has become very viscous, the user has decided to heat the material at 100°F during purging.

### STEP 1. SYSTEM MODE

Be sure the system is in "STOP" state as shown.

#### ! WARNING

Fluid in hoses and proportioner may be under high pressure. Follow the pressure relief procedures described in this manual.

### STEP 2. SUPPLY LINES AND HOSE

Make sure that the A-side supply lines, recirculation hoses, and distribution hoses are correctly connected.

### STEP 3. ANALOG PRESSURE GAUGE

Examine the pressure gauge on the A fluid module. If the gauge pressure is over 300 psi (20.4 bar) relieve pressure by opening the recirculation valve in the STOP position.

### STEP 4. FILTER VALVES

Set filter valve (4a) to open position (horizontal). Set the recirculation valve (4b) to spray position (pointed down).

### STEP 5. A SIDE PUMP

Activate the A-side transfer pump.

### STEP 6. HOSE MANIFOLD

Remove the spray gun from the hose manifold. Secure or hold the manifold over a waste container and open the A-side material control valve to catch fluid. Fluid may begin flowing out of the manifold at this point. This is acceptable.

### STEP 7. EXCHANGE MODE

After selecting Exchange Mode from the main menu:

- 7a. Select **Purge** from the "FUNCTION" menu.
- 7b. Select **A-ISO** from the "MATERIAL" menu.
- 7c. Select **Preheat and Hose** from the "HEAT" menu.
- 7d. Select **Manual** from the "METHOD" menu.

#### ! WARNING

Do not activate the heating mode when air or gas is present in the Proportioner or Hoses. This can cause the heater elements to fail and can create a fire hazard.

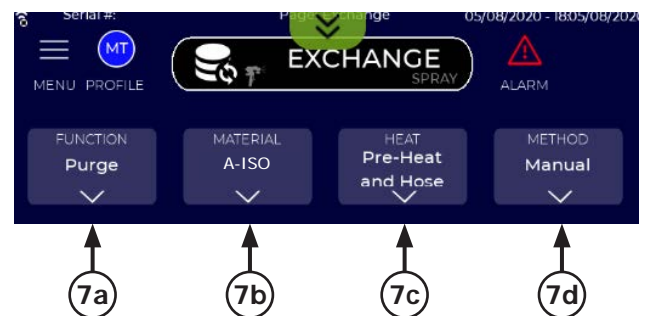
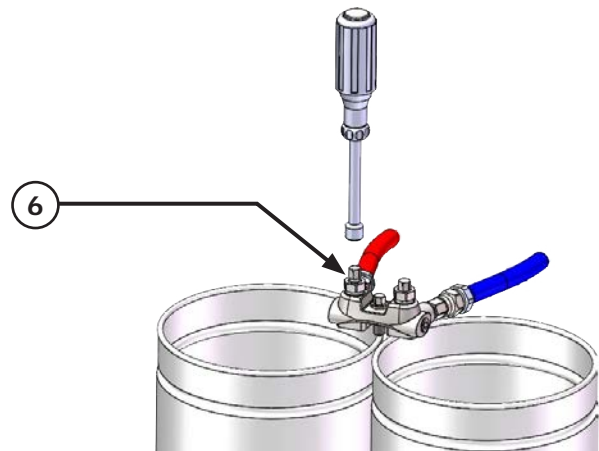
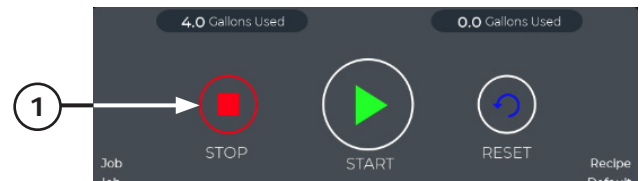

**STEP 8. SET A SIDE TEMPERATURE**

Set the A-side temperature to 100°F. Press the – and + buttons in the Temperature Widget.

**STEP 9. SET B MOTOR SPEED**

Set B motor speed to 0% by pressing the — button in the Motor Speed Widget.

**STEP 10. SYSTEM MODE**

Press the "START" button to begin purging and heating.

**Note, there is no warmup cycle in Exchange Mode.**

If the material needs to be heated before turning pumps on, set motor speed to 0% or run at low speeds until fluid is warmed. Otherwise fluid will be heated during pumping.

**STEP 11. INCREASE B MOTOR SPEED**

Increase motor speed by pressing the + button in the Motor Speed Widget.

As the motor (jog) speed is increased, the pump pressure will rise. While higher speeds reduce the purge time, they can also cause an overpressure situation and/or cause material cavitation in the pump and possible pump damage. Most Exchange functions can be operated at 50% or lower motor speed settings.

The user can adjust motor speed at any time while purging fluid.

- 11a. Real Time Material Flow
- 11b. Real Time Pump Pressure
- 11c. Real Time B Motor Speed

**STEP 12. FLUID FLOW**

When an adequate amount of fluid is purged press the "STOP" button. To restart purging, press the "START" button.

The same steps shown here can be used to bleed the B-side material or to remove any injected air in the A or B-side.

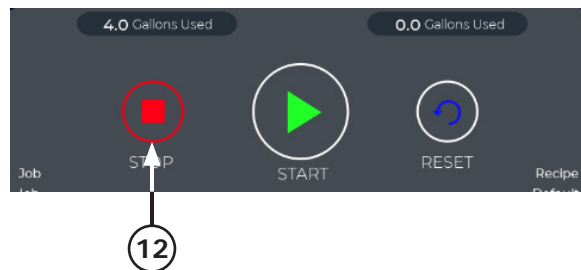
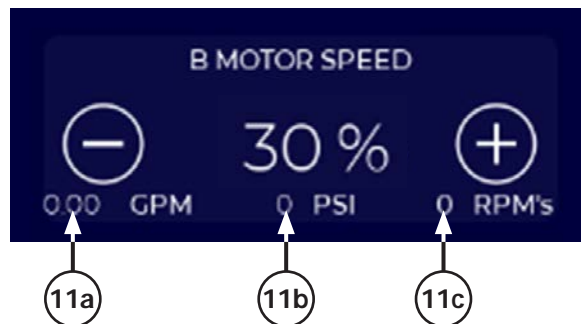
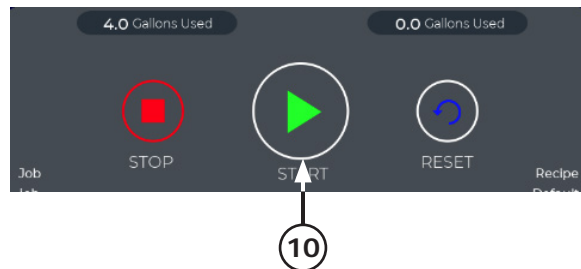
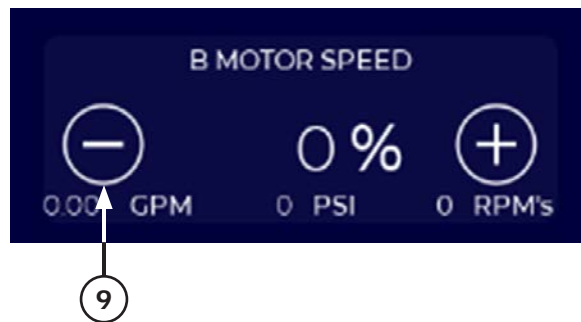

### EXAMPLE 3–B SIDE PURGE AMOUNT

In this example a user wants to purge 3 gallons of B material when doing a change-over from Closed Cell (CC) to Open Cell (OC) resin. The user has decided to operate the hose heaters at 100°F during the purge process.

#### STEP 1. SYSTEM MODE

Be sure the system is in "STOP" state as shown.

### ! WARNING

Fluid in hoses and proportioner may be under high pressure. Follow the pressure relief procedures described in this manual.

#### STEP 2. SUPPLY LINES AND HOSE

Make sure that the B-side supply lines, recirculation hoses, and distribution hoses are correctly connected.

#### STEP 3. ANALOG PRESSURE GAUGE

Verify the pressure gauge on the B fluid module. If the gauge pressure is over 300 psi (20.4 bar) relieve pressure by opening the recirculation valve in the "STOP" position.

#### STEP 4. FILTER VALVES

Set filter valve (4a) to open position (horizontal). Set the recirculation valve (4b) to spray position (pointed down).

#### STEP 5. B SIDE PUMP

Activate the B-side transfer pump.

#### STEP 6. HOSE MANIFOLD

Remove the spray gun from the hose manifold. Secure or hold the manifold over a waste container and open the B-side material control valve to catch fluid. Fluid may begin flowing out of the manifold at this point. This is acceptable.

#### STEP 7. EXCHANGE MODE

After selecting Exchange Mode from the main menu:

7a. Select **Purge** from the "FUNCTION" menu.

7b. Select **B-RES** from the "MATERIAL" menu.

7c. Select **Hose** from the "HEAT" menu.

7d. Select **Amount** from the "METHOD" menu.

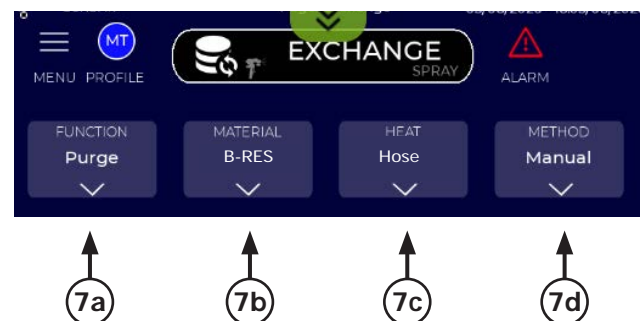
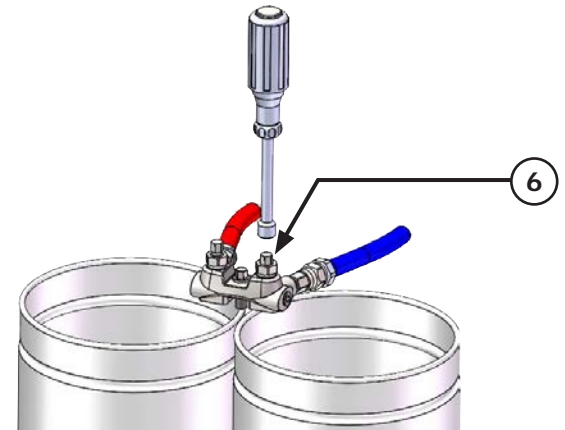
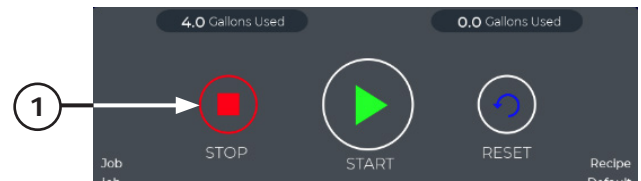



**STEP 8. SET B SIDE TEMPERATURE**

Set the B-side temperature. Press the – (8a) and + (8b) buttons in the Temperature Widget.

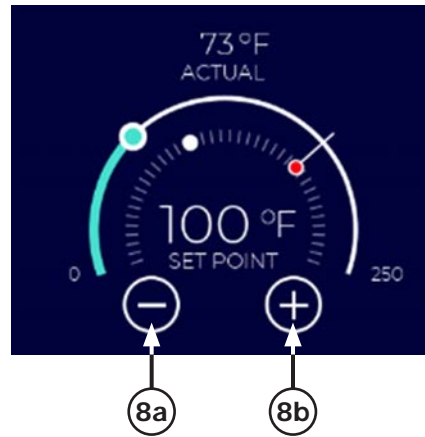

**STEP 9. SET PURGE AMOUNT**

Note that the Target amount to purge now appears next to the B drum icon. Press on the Target window and enter the amount to purge (in this example 3 gallons). While purging, the total amount of material purged will be indicated next to the Target value.

**STEP 10. SET B MOTOR SPEED**

Set B motor speed to 0% by pressing the — button in the Motor Speed Widget.

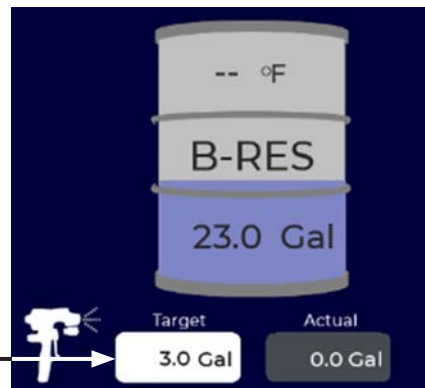

**STEP 11. SYSTEM MODE**

Press the "START" button to begin purging and heating.

**Note, there is no warmup cycle in Exchange Mode.**

If the material needs to be heated before turning pumps on, set motor speed to 0% or run at low speeds until fluid is warmed. Otherwise fluid will be heated during pumping.

**STEP 12. INCREASE B MOTOR SPEED**

Increase motor speed by pressing the + button in the Motor Speed Widget.

As the motor (jog) speed is increased, the pump pressure will rise. While higher speeds reduce the purge time, they can also cause an overpressure situation and/or cause material cavitation in the pump and possible pump damage. Most Exchange functions can be operated at 50% or lower motor speed settings.

The user can adjust motor speed at any time while purging fluid.

- 12a. Real Time Material Flow
- 12b. Real Time Pump Pressure
- 12c. Real Time B Motor Speed
- 12d. Motor Speed Increase

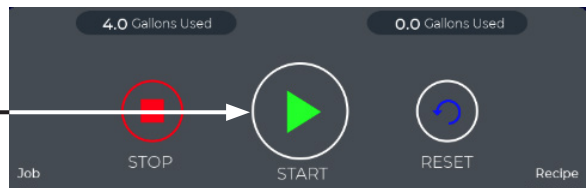
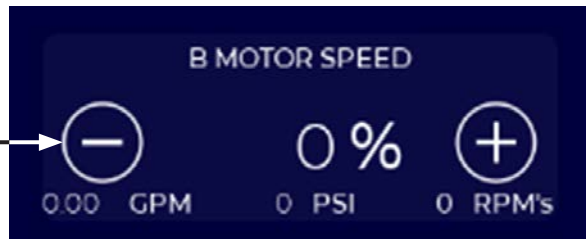

**STEP 13. FLUID FLOW**

When the actual amount of material purged equals the target value the system will automatically go to "STOP" state and fluid purge will stop.

**STEP 14. B SIDE MATERIAL CONTROL**

Close the B-side material control valve on the gun manifold and reattach the gun.

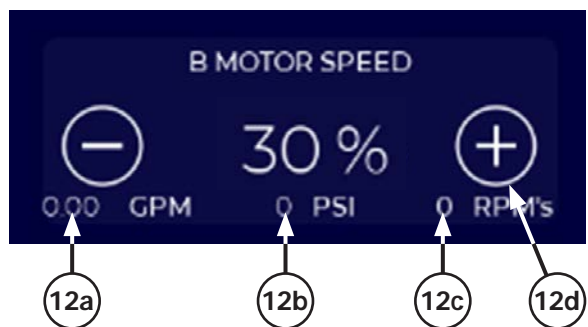



**EXAMPLE 4—PREHEAT B DRUM MATERIAL**

In this example the material in the B (resin) drum will be heated to 90°F before spraying. Once the material reaches the target temperature the IS30 will automatically stop recirculation.

**STEP 1. SYSTEM MODE**

Be sure the system is in "STOP" state as shown.

**STEP 2. SUPPLY LINES AND HOSE**

Make sure that the B-side supply lines, recirculation hoses, and distribution hoses are correctly connected.

**STEP 3. FILTER VALVES**

Open B-side filter valve (3a) and set the recirculation valve (3b) to drum position as shown in the following figure.

**STEP 4. TRANSFER PUMP**

Activate B-side transfer pump. B-side fluid may begin to recirculate to the drum. This is acceptable.

**STEP 5. EXCHANGE MODE**

After selecting Exchange Mode from the main menu:

- 5a. Select **Recirculation** from the "FUNCTION" menu.
- 5b. Select **B-RES** from the "MATERIAL" menu.
- 5c. Select **Preheat** from the "HEAT" menu.
- 5d. Select **Temp** from the "METHOD" menu.

**STEP 6. DRUM FLUID TEMPERATURE**

Enter the target drum fluid temperature of 90°F in the window below the B drum icon. The actual temperature will be displayed both below and on the drum icon when fluid starts to recirculate.

**STEP 7. SET B MOTOR SPEED**

Set B motor speed to 0% by pressing the — button in the Motor Speed Widget.

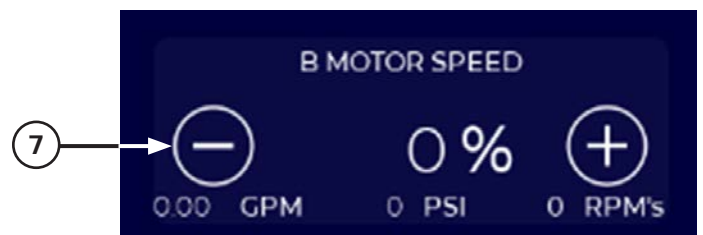
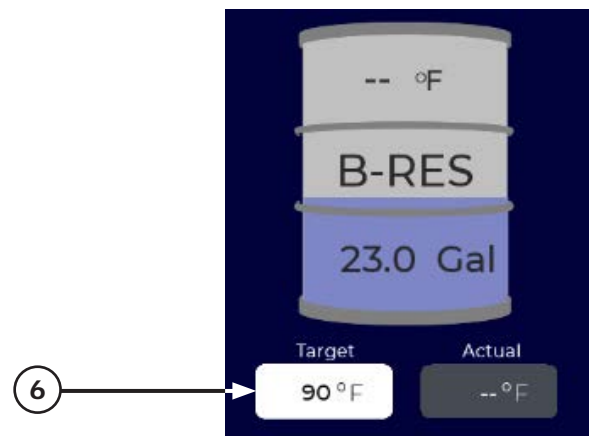
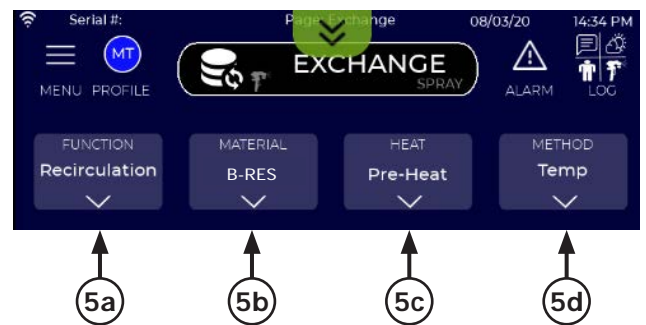
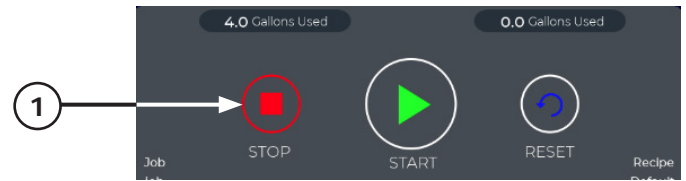

**STEP 8. SYSTEM MODE**

Press the "START" button to begin the recirculation and fluid heating operation.

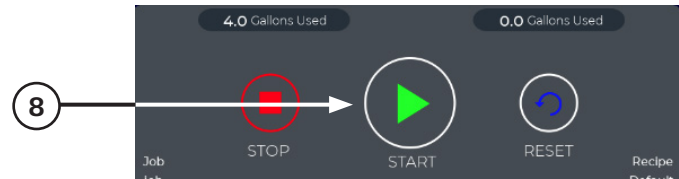
**STEP 9. INCREASE B MOTOR SPEED**

Increase B motor speed by pressing the + button in the Motor Speed Widget. While most Exchange functions can be operated at 50% or lower motor speed settings, in recirculation mode motor speed can be increased to accelerate preheating the fluid in the drum.

**STEP 10. RECIRCULATION AUTO-STOP**

The IS30 will automatically stop recirculation when the actual incoming fluid temperature reaches the user-specified target temperature.

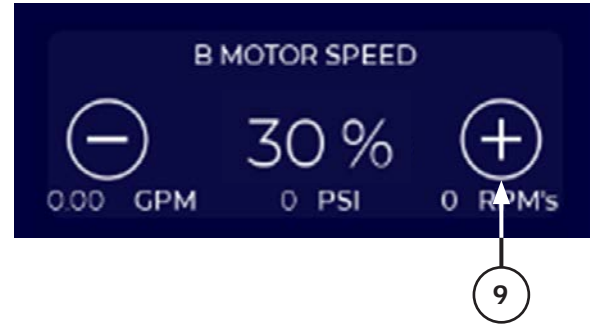

### EXAMPLE 5–SIDE AIR PURGE

When changing B-side materials, minimizing mixing different materials and/or fluid waste may be important. Changing from Open to Closed Cell resins is a good example, as is switching between some Open Cell formations.

Simply pushing through a different B material is acceptable from a hardware standpoint, but it can require “spraying out” or purging a large amount of waste material.

The IntelliSpray Proportioner can use compressed air or inert gas with the Purge function on the B-side. This is referred to as performing an “Air Purge.” Compressed air cannot effectively leak through the proportioner gear pumps and may not spin under air pressure alone.

Operating the B motor at low speed allows Air Purge to push material through the system effectively.

#### ! WARNING

Do not purge the proportioner or hoses with a flammable or oxidizing gas or liquid. An explosion and/or fire can result with significant personal injuries, loss of life, and property damage.

#### ! CAUTION

Air purge must not be used on the A (ISO) side. This will cause the ISO to harden in the system fluid passages and hoses.

To perform an Air Purge, a quick-connect air fitting and check valve (or ball valve) should be installed on the B (Resin) supply line. This will prevent fluid from coming back through the air fitting.

### STEP 1. SYSTEM MODE

Be sure the system is in “STOP” state as shown.

### STEP 2. SUPPLY LINES AND HOSE

Shut off the B-side transfer pump and close the transfer pump outlet valve if so equipped.

### STEP 3. B SIDE TRANSFER PUMP

To minimize cross-contamination remove the B-side transfer pump from the old drum and drain per manufacturer’s recommendations. If some cross-contamination is acceptable this step can be skipped.

### STEP 4. B SIDE RECIRCULATION

Confirm that the B-side recirculation hose is connected to the B drum or directed into a waste container.

### STEP 5. B SIDE FILTER INLET

Verify that the B-side filter inlet and outlet valves are in the open position (turned CW to stop) and set the recirculation valve to the drum position.

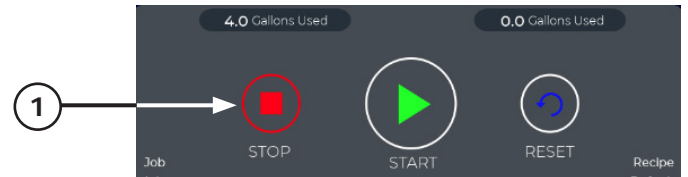

### STEP 6. EXCHANGE MODE

After selecting Exchange Mode from the main menu:

- 6a. Select **Purge** from the "FUNCTION" menu.
- 6b. Select **B-RES** from the "MATERIAL" menu.
- 6c. Select **OFF** from the "HEAT" menu.
- 6d. Select **Manual** from the "METHOD" menu.

### ! WARNING

Do not activate the heat mode during an air purge operation. This can cause the heater elements to fail and can create a fire hazard.

### STEP 7. SET B MOTOR SPEED

Recommended step: Set B motor speed to 0% by pressing the — button in the Motor Speed Widget.

### STEP 8. AIR VALVE

Attach the compressed air line and/or open the air valve to apply air pressure into the supply line. The pump may start to spin from this air pressure. This is acceptable.

Air pressure should be between 70-150 psi. Inlet air pressure above 150 psi can cause pump seal failure.

### STEP 9. LOW PRESSURE ALARM RESET

If the system displays a low pressure alarm, press "RESET". Press the "START" button to begin purging the B fluid and replacing with compressed air.

### STEP 10. INCREASE B MOTOR SPEED

Increase B motor speed by pressing the + button in the Motor Speed Widget. Motor speeds should be limited to 5% or less when performing an Air Purge to avoid damage to the pump bearings and internal surfaces.

Since the recirculation valve is still in the drum position (Step 5), the initial purge will push B-side material from the supply hose, proportioner, and recirculation line back into the drum or waste container.

Continue purging until air is flowing steadily out of the recirculation hose.

### STEP 11. B SIDE MATERIAL CONTROL

Press the "STOP" button when air is flowing steadily out of the recirculation hose.

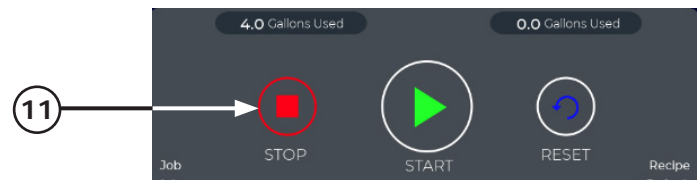
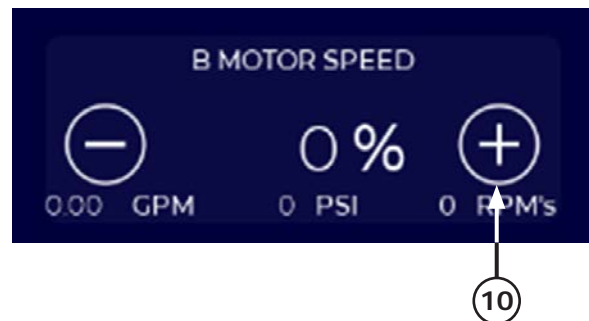
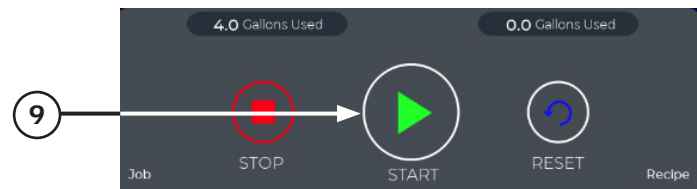
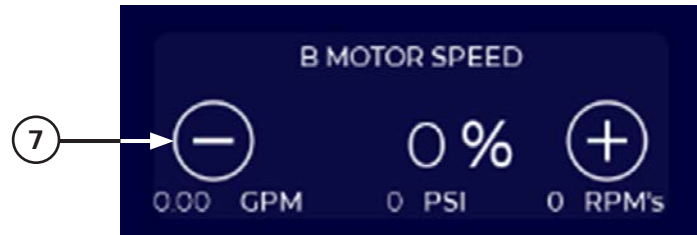
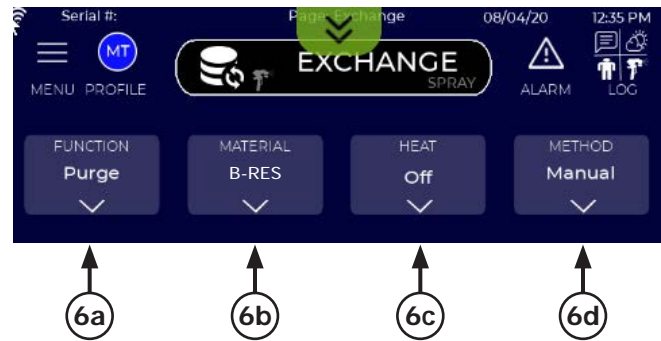

**STEP 12. RECIRCULATION VALVE**

Turn the recirculation valve to spray position as shown in the following figure.

**STEP 13. B SIDE MATERIAL CONTROL**

Remove the spray gun from the hose manifold. Secure or hold the manifold over a waste container and open the B material control valve to catch fluid.

**STEP 14. SET B MOTOR SPEED**

Recommended step: Set B motor speed to 0% by pressing the — button in the Motor Speed Widget.

**STEP 15. SYSTEM MODE**

Press the "START" button to begin purging of the old B fluid and replacing with compressed air.

**STEP 16. INCREASE B MOTOR SPEED**

Increase B motor speed by pressing the + button in the Motor Speed Widget. Motor speeds should be limited to 5% or less when performing an Air Purge to avoid damage to the pump bearings and internal surfaces.

Since the recirculation valve is still in the drum position (Step 12), the initial purge will push B-side material from the supply hose, proportioner, and recirculation line back into the drum or waste container.

Continue purging until air is flowing steadily out of the recirculation hose.

**STEP 17. MANIFOLD AIR FLOW**

Press STOP when air is flowing steady out of the manifold. The Air-Purge cycle is now complete.

**STEP 18. B SIDE MATERIAL CONTROL**

Close the B-side material control valve on the gun manifold.

**STEP 19. AIR VALVE**

Shut off the compressed air valve (or disconnect air line) at the drum pump used for air purging.

**STEP 20. DRUM PUMP**

Insert drum pump in new material drum.

**STEP 21. DRUM PUMP**

Use Exchange mode to refill the B-side with the new material (see Example 1 - Initial System Bleed for reference).

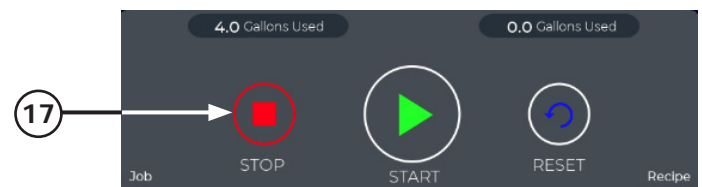
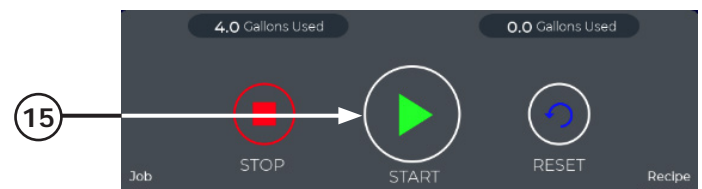
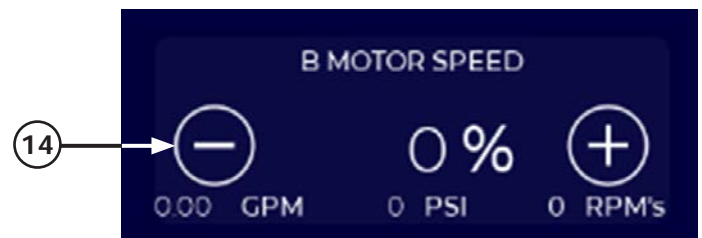
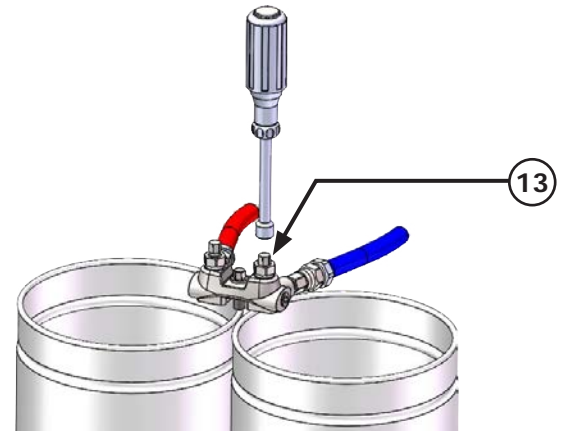

## ALARM SCREEN—OVERVIEW

The IntelliSpray Proportioner displays and categorizes Alarms as either **Errors**, or **Warnings**.

### ERRORS

Errors (1) occur when the proportioner detects a condition that prevents the system from operating in a safe or controlled manner. Errors are intended to prevent personal injury, equipment or property damage, or spraying outside of acceptable process limits.

When an Error occurs, the proportioner automatically enters "STOP" state and turns off power to heaters and motors.

The "ALARM" icon at the top of the active screen will change from white to red and a pop-up note will be displayed that shows error number and description.

When the proportioner has an active Error, the "RESET" button at the bottom of the screen will begin flashing.

The following are examples of conditions that will trigger an error alarm:

- Insufficient material in drum
- Insufficient drum pump pressure
- Excessive drum pump pressure
- Excessive system pressures or temperatures
- Plugged filter (pressure drop across filter too high)
- Pressure difference exceeds limits
- Component or communication failure

If the system is in an error state, the user must eliminate the error condition and press the "RESET" button before restarting the system.

The "RESET" button (2) will flash blue when an error is active. After correcting the error condition press the "RESET" button before restarting the system.

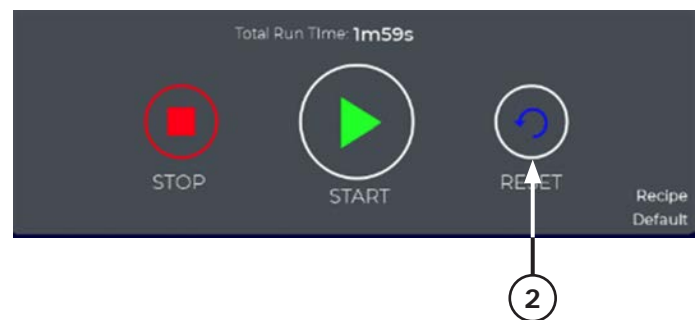



## ALARM SCREEN—USE

If the proportioner is in an "ERROR" state, the "ERROR" icon (1) will change to solid red and a pop-up message will appear showing "ERROR" number and description.

Only the most recent "ERROR" will be displayed.

In most cases the information provided in the message window will be sufficient for the user to address and resolve the error prior to restarting the system.

More information on the active or prior alarms can be obtained by entering the Alarm Screen (2). This can be accessed by pressing on the alarm icon, the alarm message, or from the main menu.

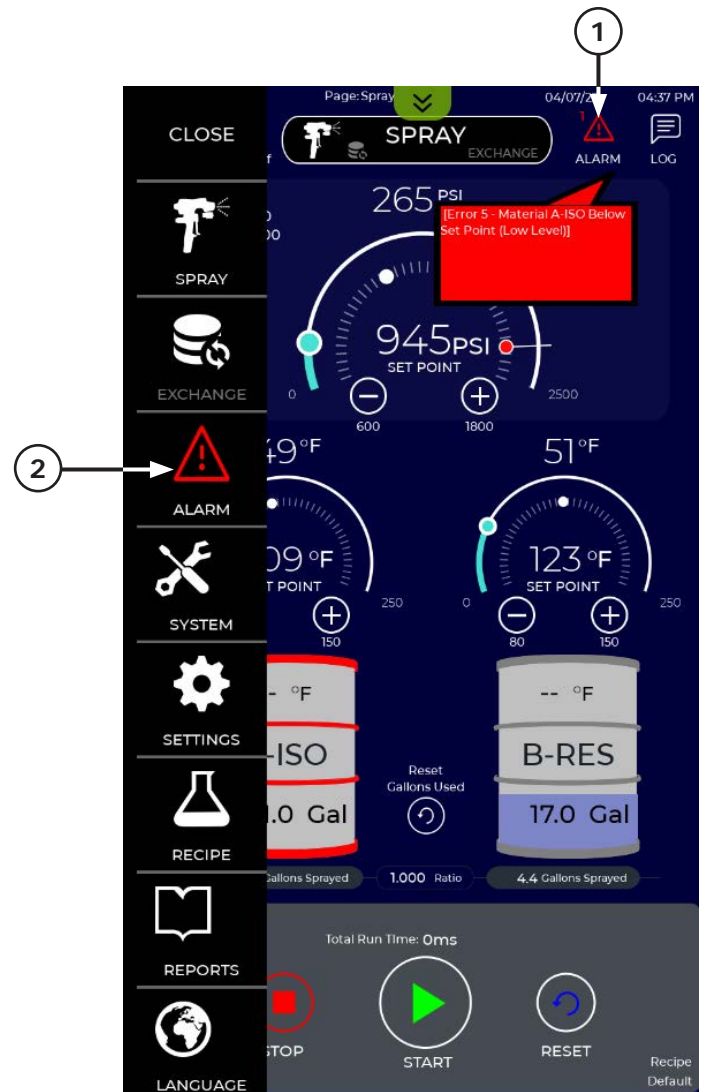

The Alarm Screen contains two tables:

The upper table displays any active errors that prevent the system from operating. Warnings are not displayed in the upper table.

The lower table shows previous Errors and Warnings. When an error is addressed and the reset button is pressed, the active error will clear and be displayed in the lower window with other past Alarms.

Warnings are only displayed in the lower table, as they do not cause the system to stop.

1. Error# and Description
2. Date and Time (when the alarm occurred).
3. Active Error(s)
4. Alarm History (Errors and Warnings)
5. Previous Alarm Screen
6. Next Alarm Screen

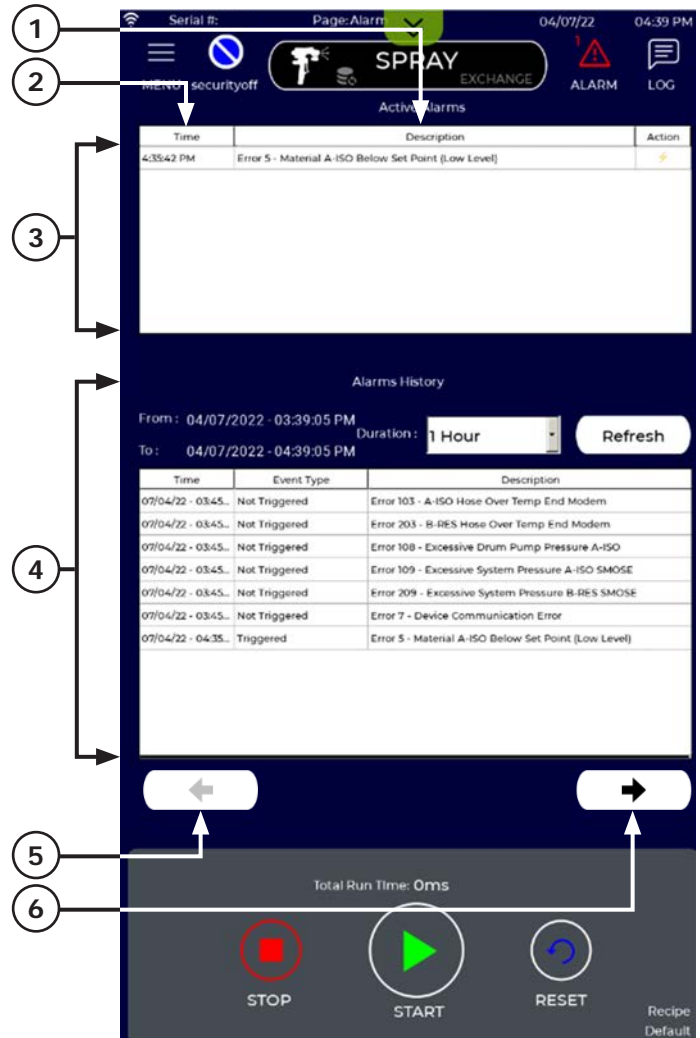

Additional information can be obtained for any active Error by pressing in the Action box (1).

A pop-up window (2) will show more information on the Error Condition and also provide recommended Actions (3) to resolve the Error.

All Errors and Actions are also contained in tables at the end of this manual for reference.

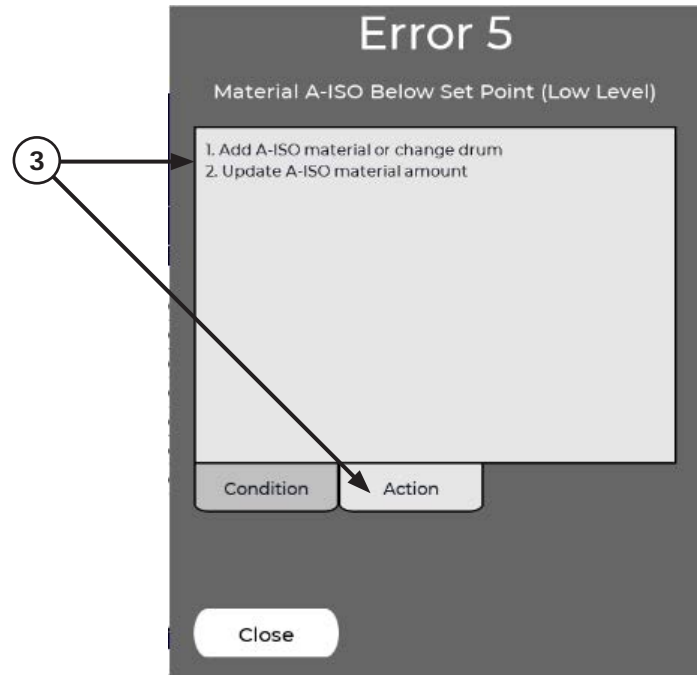
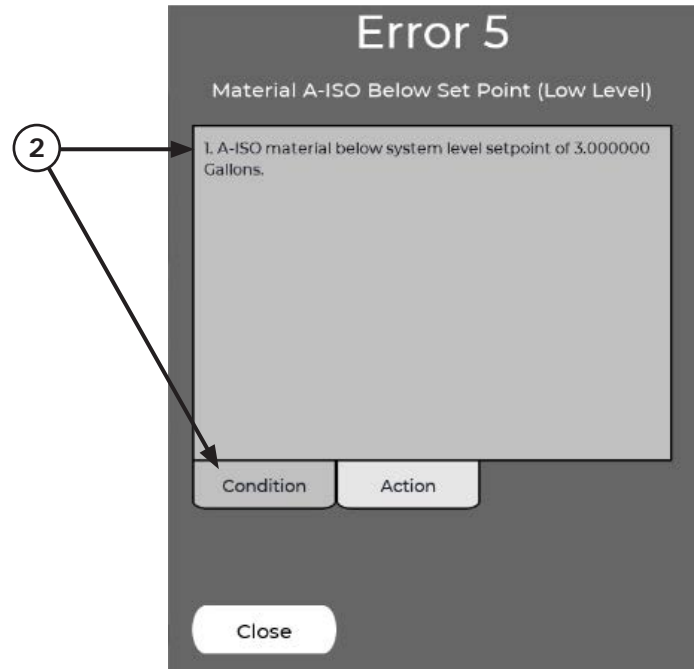
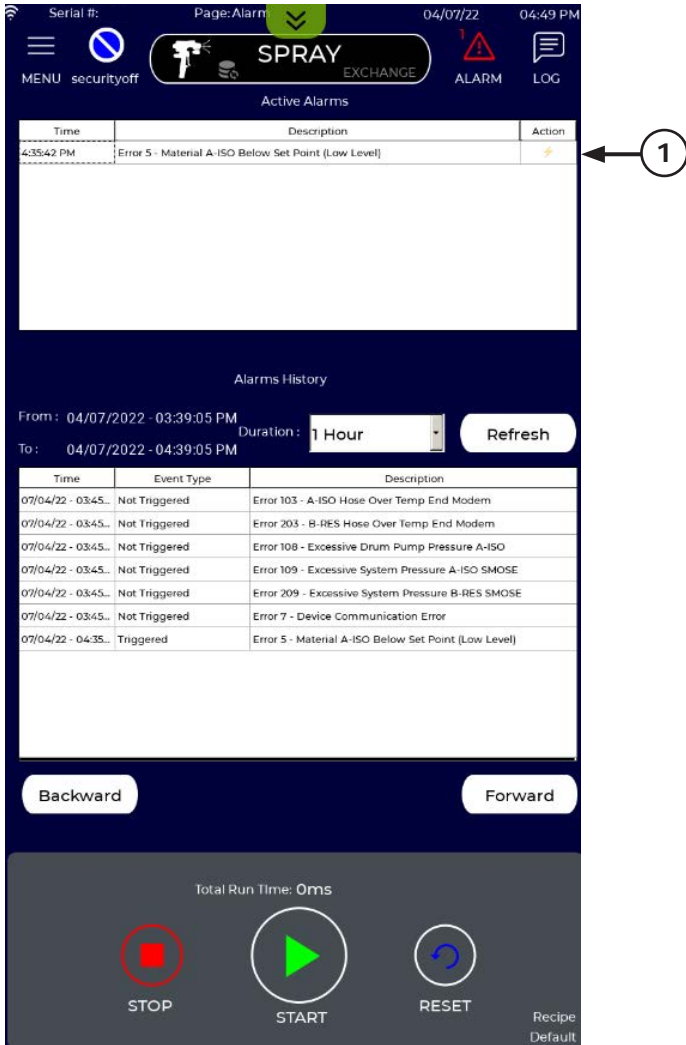

The Alarm History table displays previous Alarms (Errors and Warnings) that have occurred over a selected “look-back” time frame, which can be set from the Duration pull-down menu (1).

Press Refresh (2) to update the Alarm History Window when changing the Duration selection.

Use the Backward (3) and Forward (4) buttons to scroll through the Alarm History table.

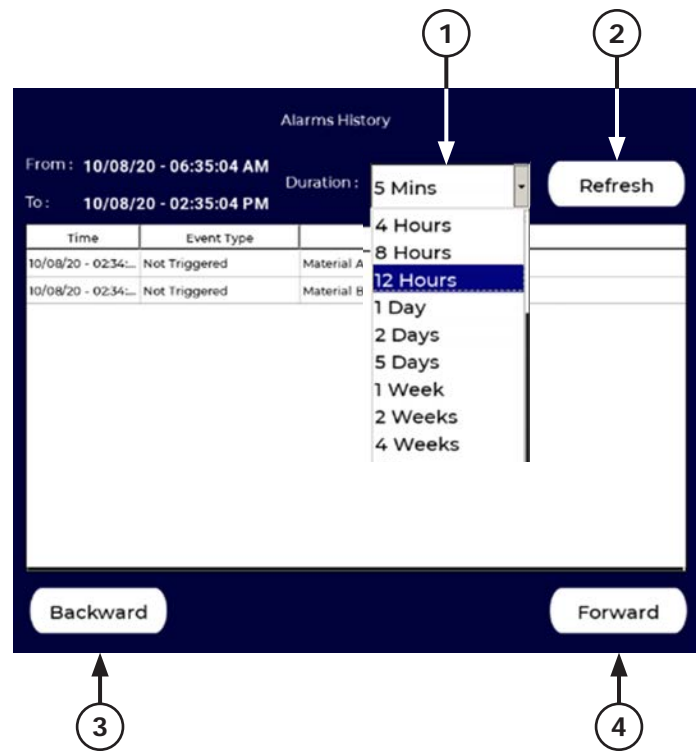

### SYSTEM STATUS SCREENS—OVERVIEW

The System Status Screens can be used for system monitoring and diagnostics.

The IS30 has three System Status Screens that can be selected from the Main Menu as shown below. Each Status Screen is described in detail in the following pages.

**IO PAGES:** Displays real-time sensor and system performance data, and accesses the Sensor Bypass capabilities of the IS30.

**Inlet Health:** Provides high resolution real-time plots of selected inlet pressures.

**Trend:** This is used to plot selected sensor and system performance data.

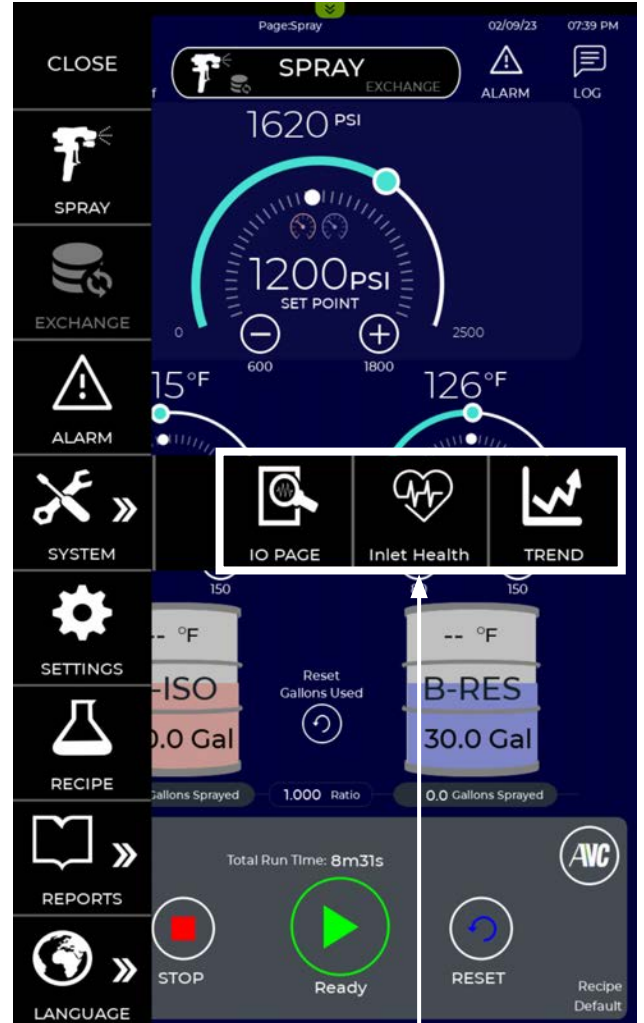
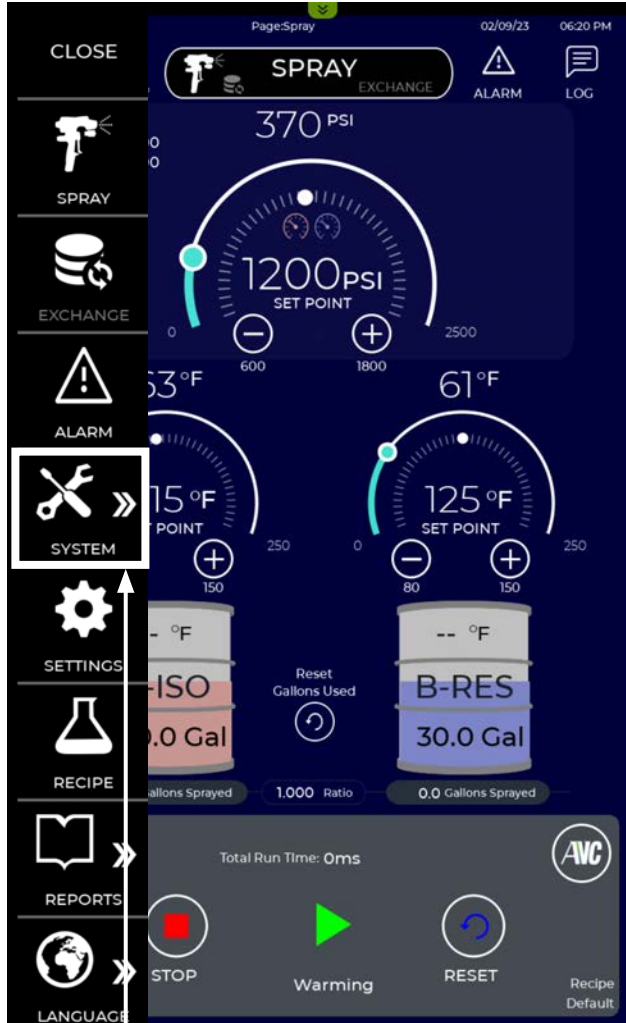

Select SYSTEM from the main menu, then select one of the three System Status screens.

**SYSTEM STATUS SCREENS—IO PAGE 1**

To access the I/O Page 1, select "IO PAGE" (1) from the SYSTEM main menu shown.

The first System Status Screen accesses two pages of I/O (Input/Output) information related to system performance.

The first I/O Page displays real-time temperature and pressure values of all A and B-side sensors in the fluid path from proportioner inlet to the end of the hose.

The A-side values are shown in the left column, and the B-side values are shown in the right column.

Fluid flow direction is from bottom (fluid inlet) to top (hose). Descriptions of all output values are shown in the following figure.

1. IO PAGE
2. Hose Fluid Pressure Drop (pump to hose end).
3. Fluid Flow Rate
4. Hose End A-B fluid Pressure Difference
5. A-B Fluid Pressure Difference Error Setting (set in Recipes).
6. Hose Fluid Temperature Change (inlet to hose end).
7. Hose End Fluid Pressure
8. Hose End Fluid Temperature
9. First Section Hose End Fluid Temperature
10. Post-Pump Fluid Pressure
11. Pre-Pump Fluid Pressure
12. Pre-Heat Output Fluid Temperature
13. Primary Pre-Heat Temperature (if installed, secondary heater temperature would be shown).
14. Inlet Fluid Temperature
15. Post-Filter Fluid Pressure
16. Fluid Pressure Drop Across Filters
17. Pre-Filter Fluid Pressure
18. Pressure Valve Indicator
19. Temperature Value Indicator
20. Sensor Bypass Screen (press to access).
21. IO PAGE 2 (press to access).

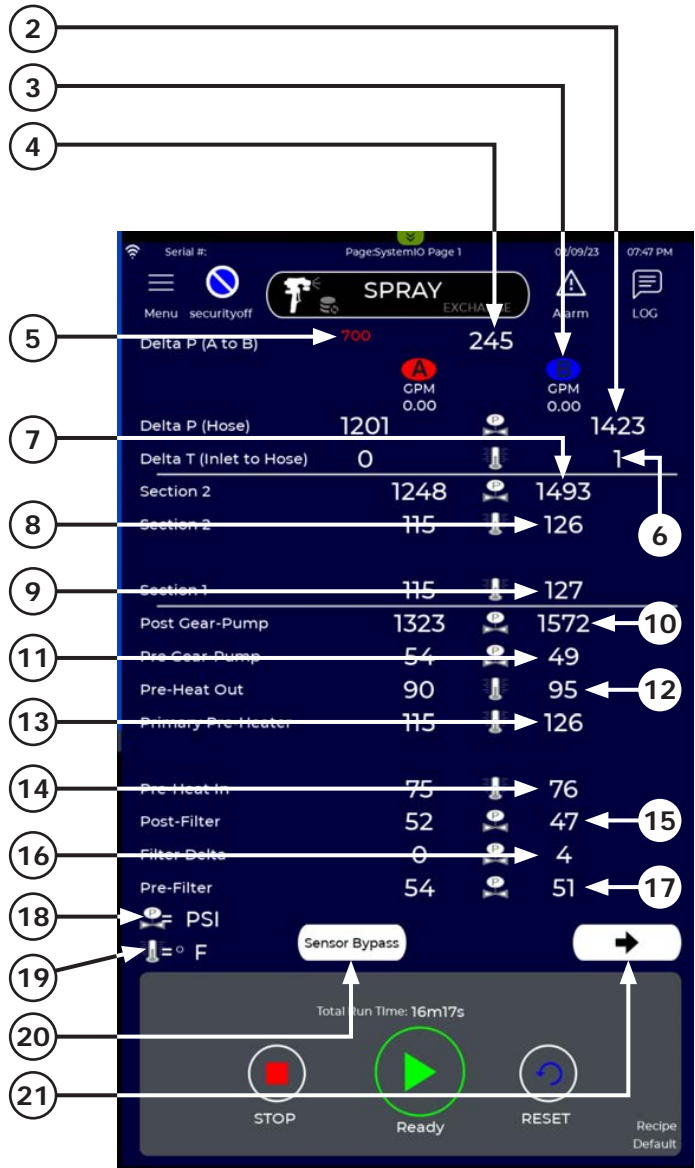



**SYSTEM STATUS SCREENS—IO PAGE 2**

I/O Page 2 of the System Status screens displays real-time machine performance.

The three sections of the screen are shown, and additional details are provided in the following pages.

All Errors and Actions are also contained in tables at the end of this manual for reference.

1. Motor and Pump Efficiency
2. Internal Status
3. Heater Status
4. IO PAGE 1 (press to access).
5. Sensor Bypass Screen (press to access).

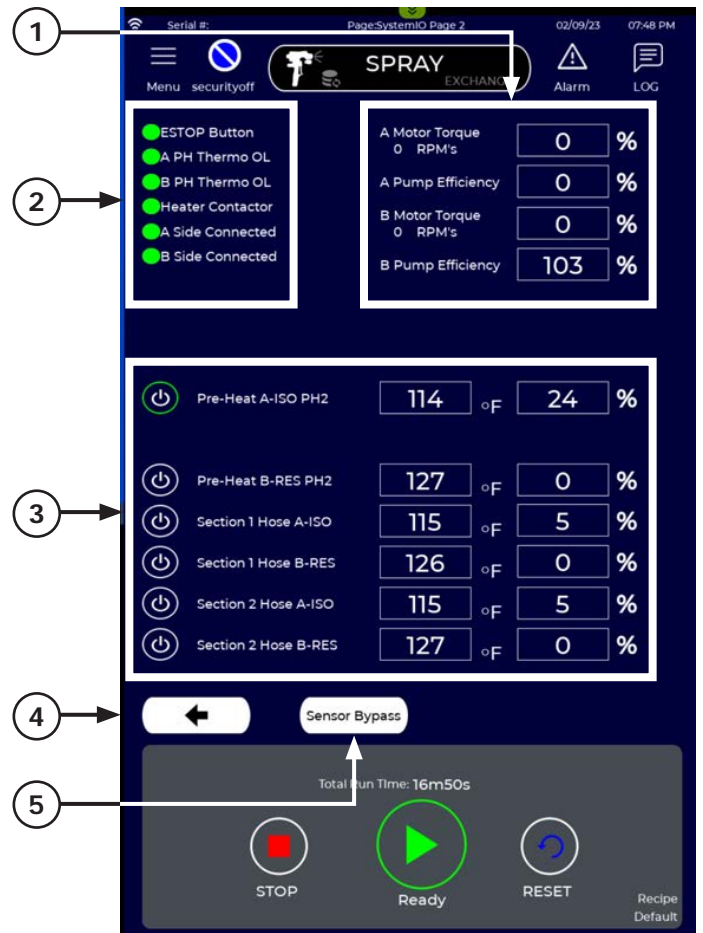

The IS30 monitors connection status of all sub-systems and displays status in the upper left portion of IO PAGE 2 (see previous page).

A red or green status light is displayed to show the connection status of each subsystem.

All lights must be green for the Proportioner to enter the "START" state.

A red light indicates a connection problem that must be addressed by the user or service technician.

1. Emergency Stop Button
2. A-Side Pre-Heat Thermal Overload Fuse
3. B-Side Pre-Heat Thermal Overload Fuse
4. Heater Contactor
5. A-Side Fluid Module (connected)
6. B-Side Fluid Module (connected)

Real-time A and B-side motor and pump performance data (7) is displayed in the upper right section of IO Page 2. This information can be useful for diagnostics, system tuning, and checking motor and pump health.

Motor torque is expressed in the percent (%) of continuous rated torque. The motors can operate indefinitely at 100% of rated torque, but can also handle short-duration peak loads up to 300% before initiating an error.

Higher torques are required when spraying higher viscosity fluids at higher flow rates (e.g. larger gun chamber/tip sizes).

Pump efficiency is the ratio of actual flow rate to theoretical flow rate. The positive displacement gear pumps have inherent slip that reduces efficiency below 100%.

Slip refers to the small amount of fluid that can leak back from the outlet side of the pump to the inlet side (a check valve prevents fluid backflow from the high pressure side of the Proportioner).

The Proportioner continuously measures and compensates for any differential slip between the A and B pumps to assure fluid ratio is maintained.

Pump efficiencies vary during a trigger cycle, with lower efficiency (i.e. higher slip) occurring when the gun is first triggered and with materials of very low viscosity. As pumps age efficiency may drop but the Proportioner will automatically compensate for this.

Pump efficiency warning and error limits can be set in the Recipe Screens. If set, these values are shown to the right of the pump efficiency values.

The upper red number shown in the figure below indicates the efficiency error level (when the system will stop).

The yellow lower number indicates the efficiency warning level (when the system will indicate a warning).

When pump efficiency drops below 50%, pump servicing may be required, or temperatures changed to reduce slip.

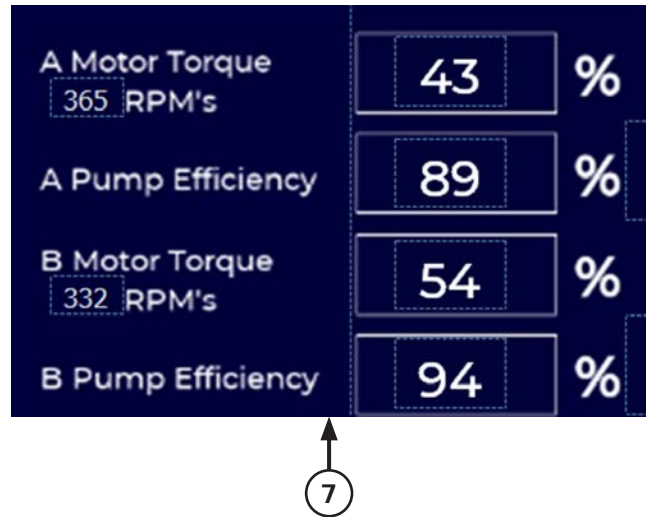
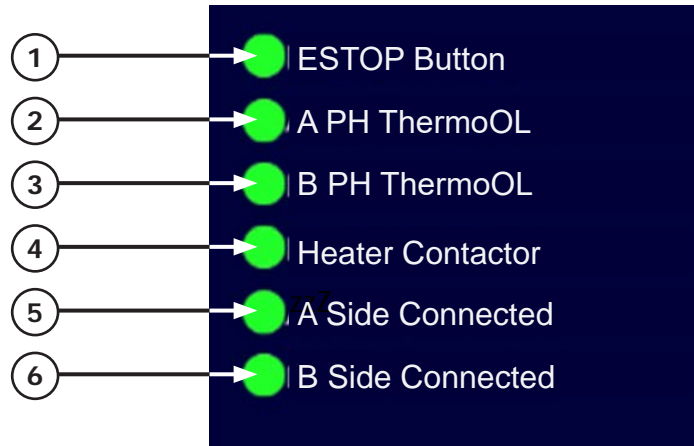

IO Page 2 of the System Status screens also shows a section for monitoring individual heater zone performance.

The temperature and duty cycle for A and B-side heating zones are displayed in the lower part of the screen. The heater duty cycle ranges from 0% (off) to 100% (full on).

With power supplied to the heater zones, their respective

power switch symbol will show a green border.

1. Solid State Relay status is (On)
2. Heater Zone Power Indicators (green border = power on)
3. Heater Zone Temperature
4. Heater Zone Duty Cycle (0% to 100%)

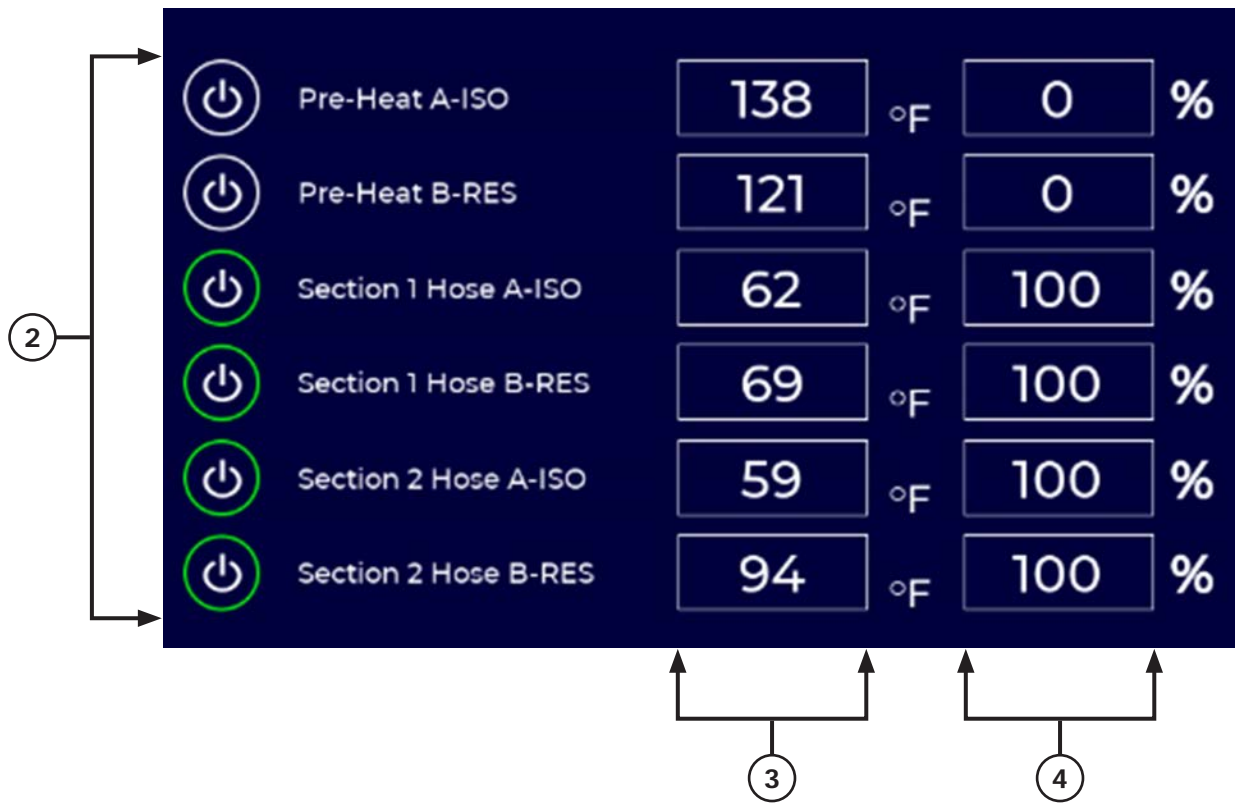
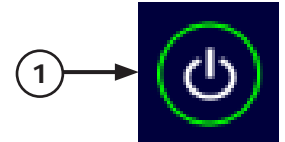

**SYSTEM STATUS SCREENS  
–SENSOR BYPASS**

In the rare event of a temperature and/or pressure sensor failure, the IS30 Sensor Bypass feature allows the user to continue spraying until the failure cause(s) can be resolved.

Activating a Sensor Bypass may cause a minor reduction in temperature and/or pressure consistency, but material ratio will not be affected.

Sensor Bypass is a temporary mode and should only be activated when sensor error(s) cannot be resolved on-site with other actions.

The Sensor Bypass Screen is accessed from I/O Screen 1 or I/O Screen 2, as shown.

1. IO PAGE 1
2. Hose Fluid Pressure Drop (pump to hose end)
3. Fluid Flow Rate
4. Hose End A-B fluid Pressure Difference

NOTICE

Sensor Bypass is a temporary use mode and may result in lower temperature and/or pressure consistency. Ratio will not be affected

I/O Screen 1

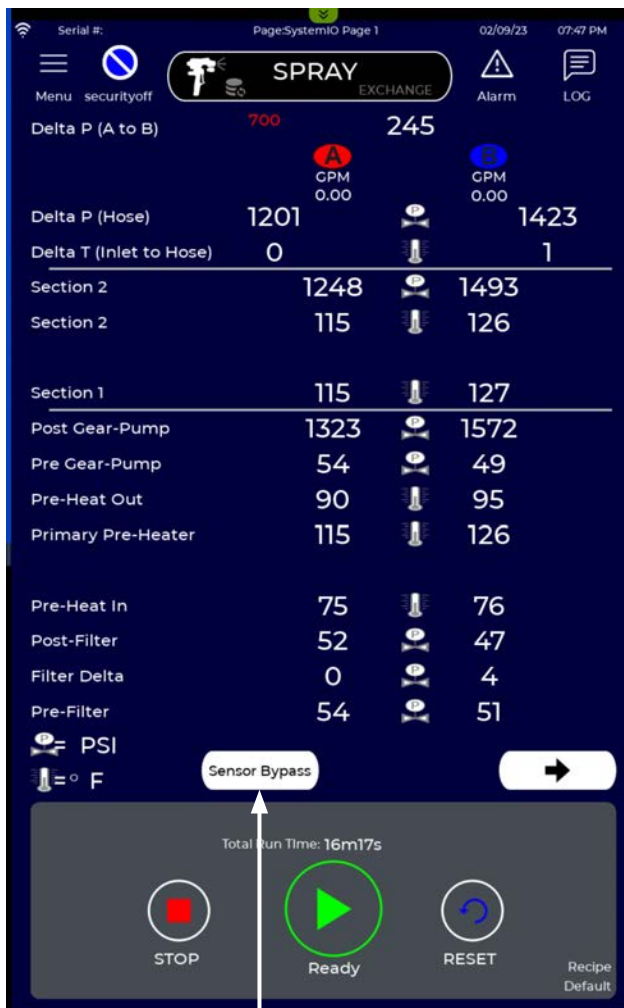

I/O Screen 2

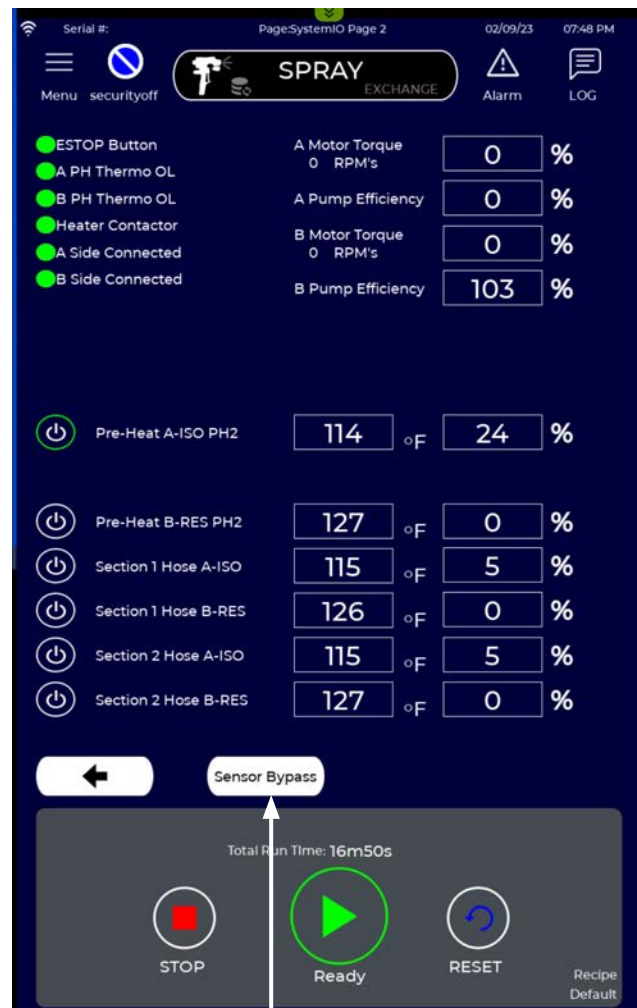

Press to access Sensor Bypass Screen

When a sensor error occurs, it will be logged in the Alarm Screen as an active error (see "ALARM SCREEN-USE").

If the error cannot be corrected, and spraying must continue, press the box next to the sensor or hose section to bypass.

Press the Close button, return to the active Mode Screen (Spray or Exchange), press Reset and Start.

After the system indicates it in Ready State, continue with the spray operation.

1. Used to bypass hose temperature or pressure sensors. This feature only works if a mid hose section is installed.
2. Used to bypass pressure sensors that are internal to the proportioner. User can select up to two pre-pump pressure sensors on A and/or B-sides.
3. Used to bypass temperature sensors that are internal to the proportioner.
4. It is possible to select multiple sensors to bypass, but some combination of selections will be invalid and prevented by the IS30.

Selections are not retained on a power cycle, and must be reselected at startup if the sensor failure has not been resolved.

**Note:** The Spray Screen will display the word "BYPASS" in the upper left corner if a sensor is being bypassed.

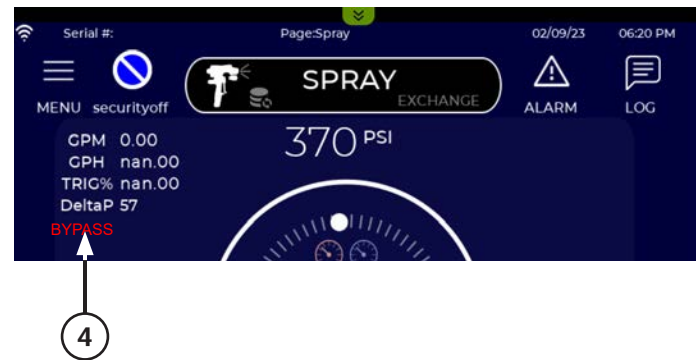
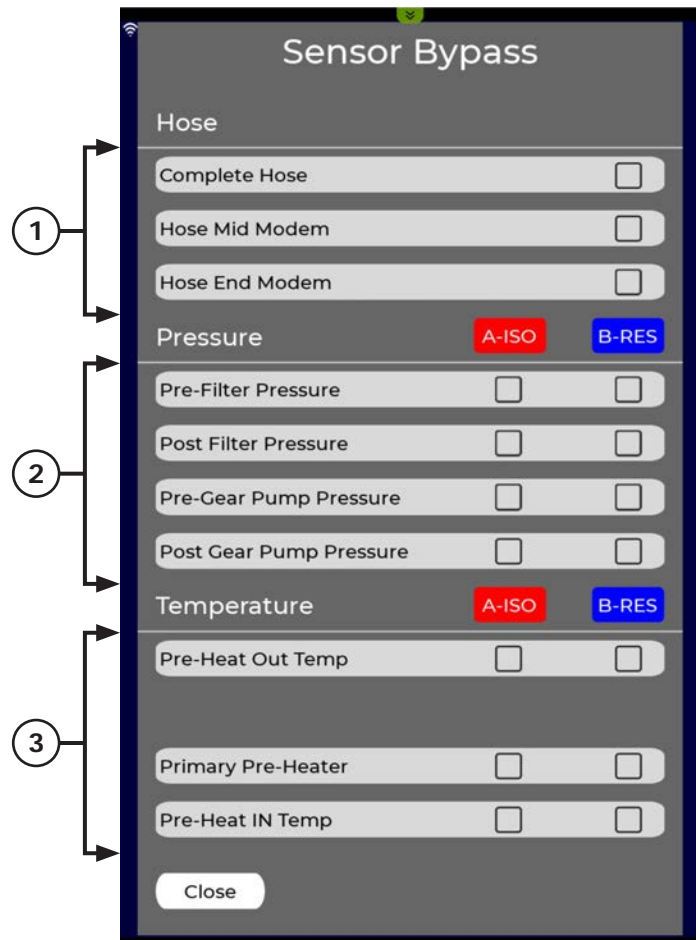

**SYSTEM STATUS SCREENS—INLET HEALTH**

The Inlet Health screen provides high resolution real-time plots of selected inlet pressures.

The data rate is 10X faster than the Trend Plot option, and can help identify and diagnose performance issues with transfer pumps (e.g. seal or check valve leakage, sticking piston, ice build up, etc).

Press the Inlet Health icon under the System menu to access the Inlet Health screen.

All selections and settings are retained, so once defined the same chart will be available any time the Inlet Health screen is opened.

1. Inlet Health Screen (describes details as shown).
2. Selection Tool (selects data to be plotted, and full scale pressure readings).
3. Plot Window (swipe left or right to move plot forward of backward in time).
4. Pressure Axis
5. Time Axis
6. Trend Time (pull-down menu to select trend screen duration in minutes).
7. Refresh Button (press to update screen after trend time changes and pressure selections).
8. Forward button. Press to move plot forward in time.
9. Backward button. Press to move plot backward in time.

**Note:** Also re centers current time to middle of plot.

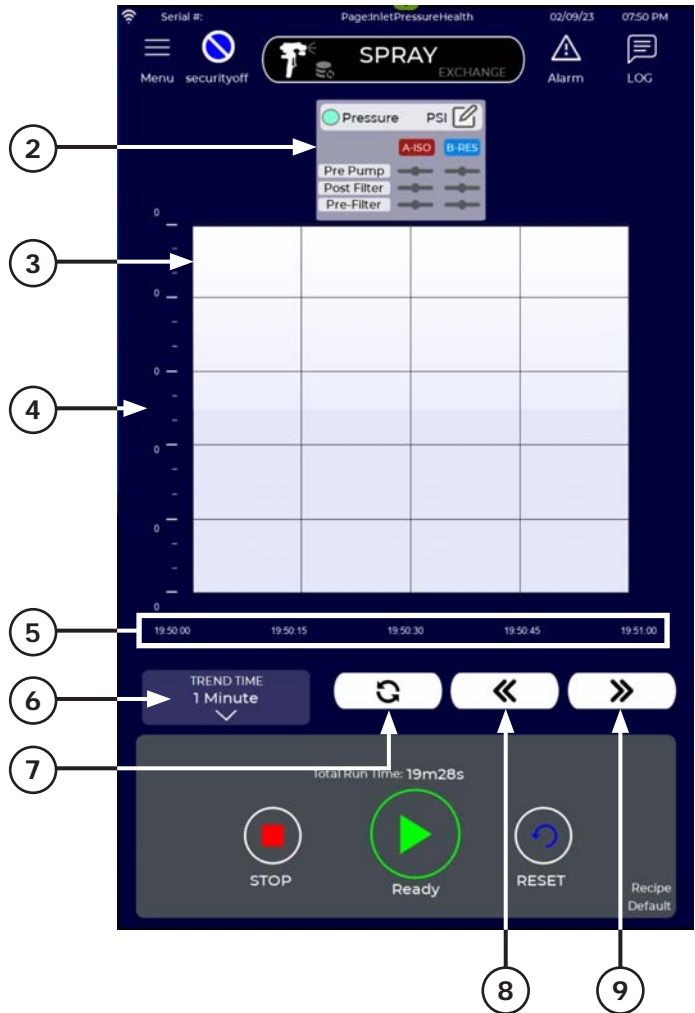



To input or change Inlet Health parameters, press on the selection tool to open the selection menu.

Refer to the following figure to select pressure values to plot and pressure scale range.

1. Selection Menu (press to open).
2. Selection Tool (up to 6 pressure value(s) to plot and indicated by a green check mark).
3. Max Trend Scale (opens menu (4) for input).
4. Enter the maximum psi scale reading on the pressure axis.
5. Selection Menu (press to close).
6. Selection Menu (press to save).

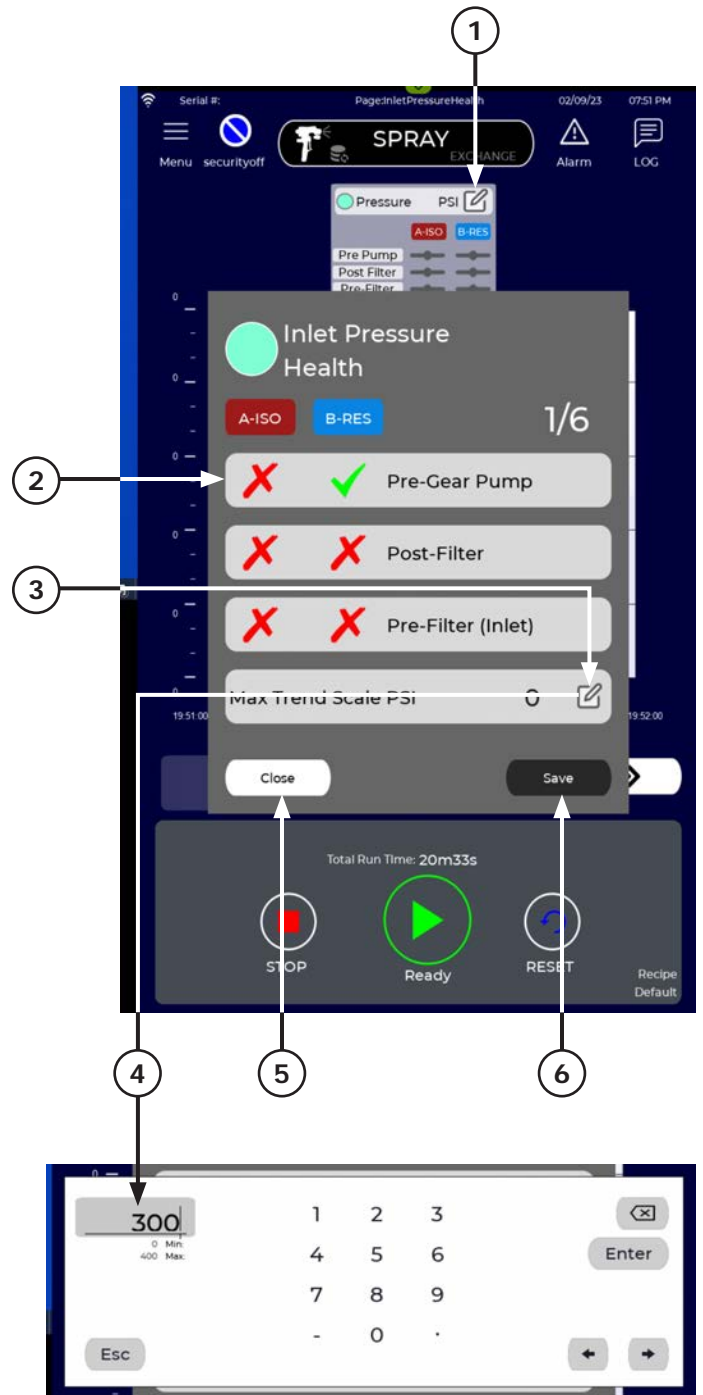

After closing the selection tool, pressure traces will be displayed. The figure shows an example plot of the A-side pre-filter pressure (blue line), and the A-side pressure at the inlet to the gear pump (red line).

The pressure pulsation in the blue line is caused by the cyclic motion of the pneumatic two-ball piston transfer pump.

The pump "wink" at the end of each stroke is seen as a momentary drop in inlet pressure in both the blue and red traces. This drop is caused by the reversal of the transfer pump, when flow stops momentarily. Notice the transfer pump does not produce the same pressure on the downward stroke (higher pressure) vs. the upward stroke (lower pressure). This is caused by the difference in the wetted area of the bottom vs. the top of the transfer piston.

The red trace shows the A-side fluid pressure just prior to entering the proportioner gear pump. It also shows the drop in pressure caused by the transfer pump "wink". The higher frequency pressure fluctuations seen in the red trace are caused by the rotation of the proportioner gear pump. The average pressure difference between the two traces is due to pressure drop through the inlet filter, flow meters, and Preheater.

In the example, the pre-gear pump pressure momentarily drops below 60 psi (4 bar) when the transfer pump reverses direction. When this happens AIC (Automatic Inlet Compensation) will become active (see "SPRAY SCREEN-AUTOMATIC INLET COMPENSATION").

Increasing transfer pump air pressure and/or warming the fluid would alleviate this condition.

1. Pre-Filter Inlet Pressure (blue trace)
2. Pre-Gear Pump Pressure (red trace)
3. Average Pressure Difference (approximate)

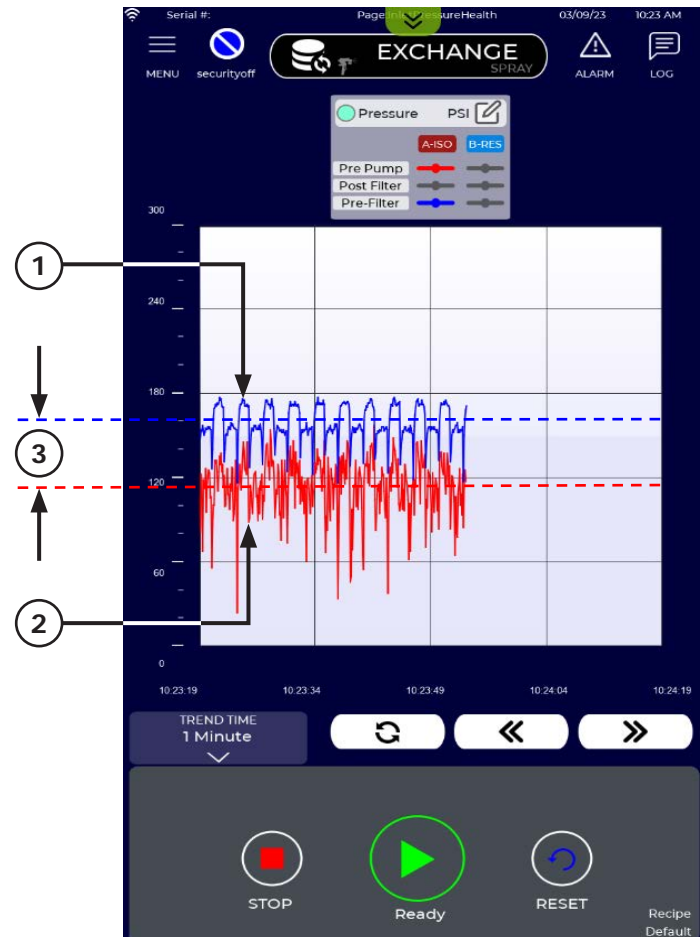

### SYSTEM STATUS SCREENS –TREND CHARTS

The System Status menu provides access to real-time charting of any sensor, set-point, machine state or performance parameter selected by the user.

Trend charts can be helpful for performing system diagnostics or performance optimization. All selections and settings are retained, so once defined the same charts will be available any time the Inlet Health screen is opened.

Selecting the Trend icon opens a screen that allows the user to select the parameters to plot against a user-defined time scale.

1. Trend Chart Screen (four sections to describe the details in the following pages).
2. Temperature Plotting (selection and display).
3. Pressure Plotting (selection and display).
4. Performance Plotting (selection and display).
5. Trend Plot (controls views).

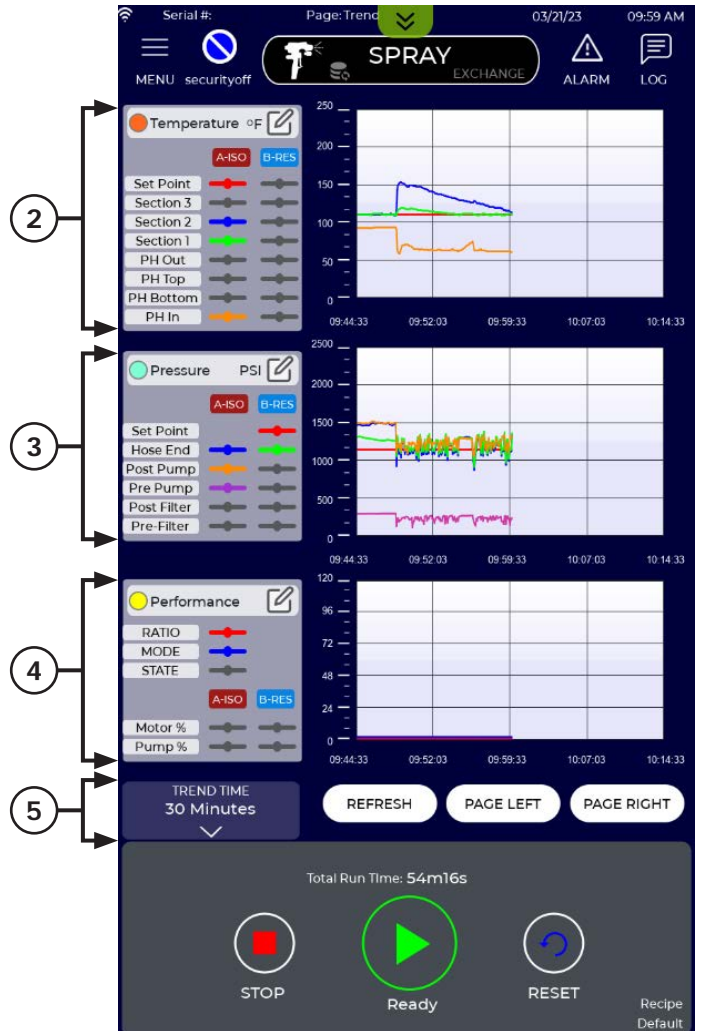

The Trend Chart screen allows the user to select the parameters to be plotted and the timescale to plot against.

The following example demonstrates the features and functions of the Trend screen.

**SELECT PLOT PARAMETERS**

To create a Temperature Trend chart begin by selecting temperatures to plot.

1. Selection Tool (press to open).
2. A-ISO or B-RES Sensors (sensors and trendline markers to show selected choices).
3. Fluid Setpoint Temperature
4. Hose Section 2 Fluid Temperature
5. Hose Section 1 Fluid Temperature
6. Preheater Outlet Fluid Temperature
7. Secondary Preheater Temperature (if installed).
8. Primary Preheater Temperature
9. Preheater Inlet Fluid Temperature

The selection tool allows up to 8 parameters to plot.

A red ✘ (10) indicates a parameter is not selected to be plotted. A green check mark ✓ (11) indicates a parameter is selected to be plotted.

Press on the ✘ or check-mark ✓ to toggle between selected and unselected state. In the example, four temperatures have been selected to plot.

After selecting temperature parameters press the Save button. The selected parameters will now be shown in the temperature legend along with their corresponding trendline markers.

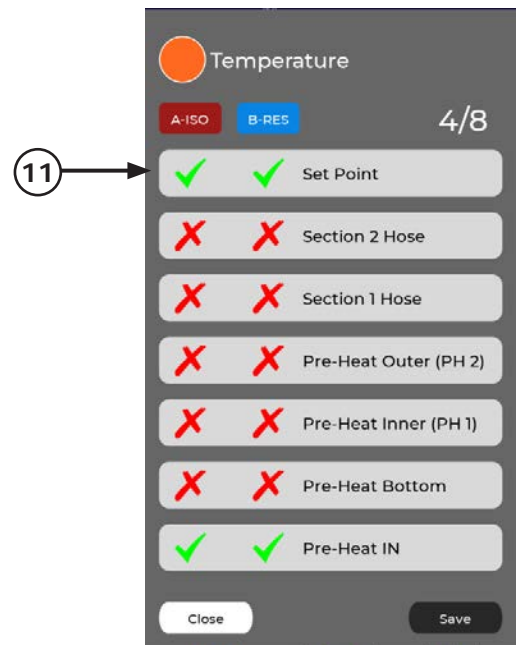
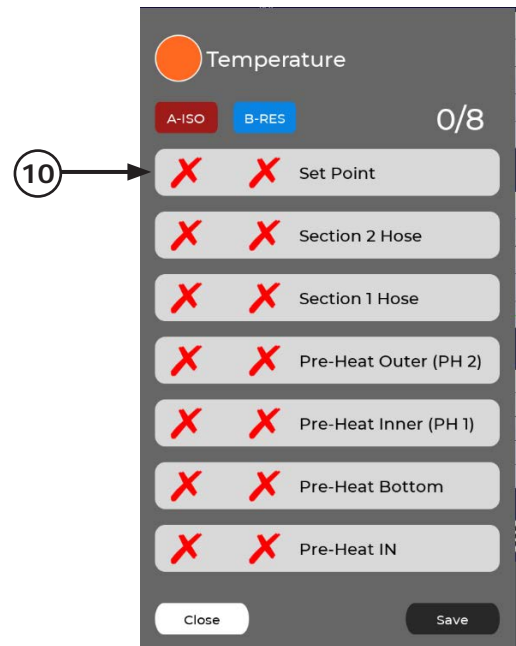
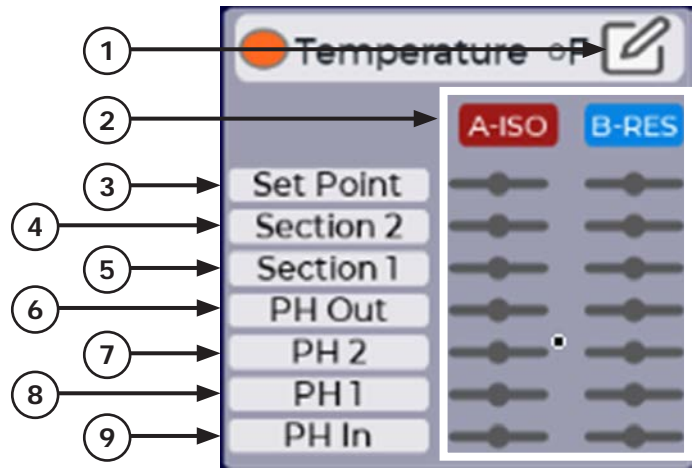

Continue selecting pressure and/or performance parameters to plot using their respective selection tools. Press the Save button when selections are completed.

1. Set Point (fluid pressure at last hose modem).
2. Hose End (fluid pressure at last hose modem).
3. Post Gear Pump (fluid pressure at pump outlet).
4. Pre-Gear Pump (fluid pressure at pump inlet).
5. Post-Filter (fluid pressure at filter outlet).
6. Pret-Filter (fluid pressure at filter inlet).
7. Ratio (fluid A:B)
8. System Mode (Spray or Exchange).
9. System State (Off, Ready)
10. Motor Load (Torque) %
11. Pump Efficiency

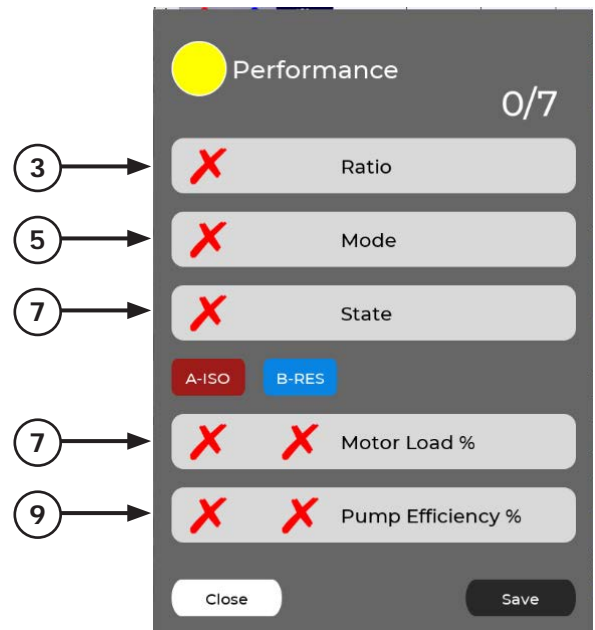
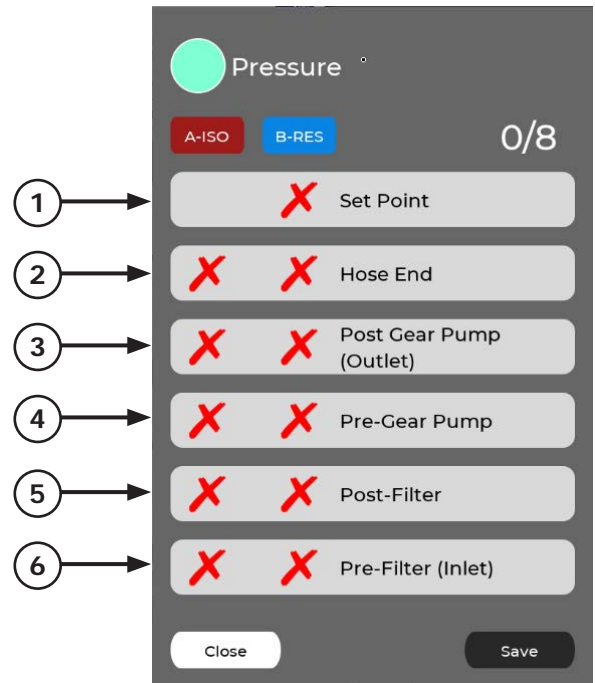

**SELECT TIME SCALE (TREND TIME)**

After selecting the parameters to plot, select the "TREND TIME" from the pull-down menu and press "REFRESH" to update the time-scale. This sets the trend chart horizontal axis.

Pressing "REFRESH" places the current time in the center of the chart.

The chart can be moved backwards or forwards in time by pressing the "PAGE LEFT" or "PAGE RIGHT" button or by swiping the chart to the right or left with a finger.

1. Select "TREND TIME" (displays on time period charts).
2. Press to refresh and center current time on plot.
3. Press to page backward in time.
4. Press to page forward in time.

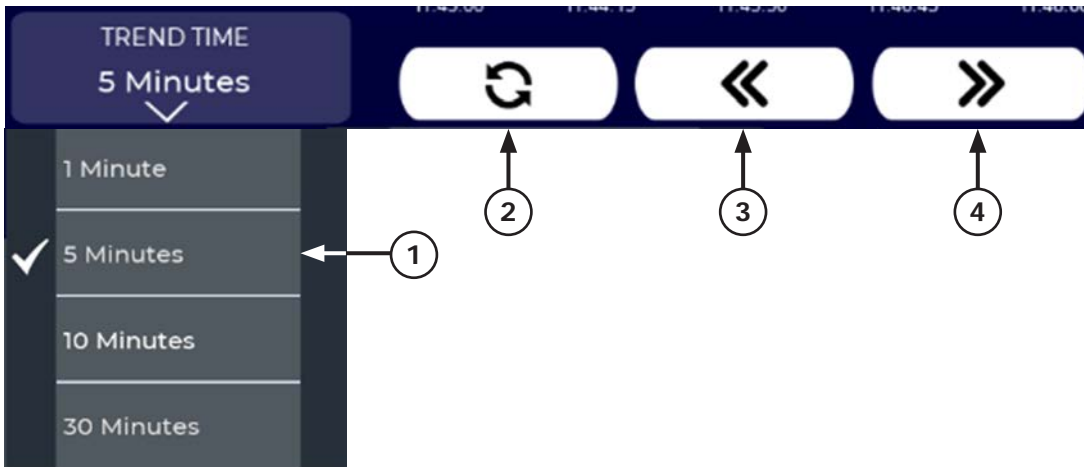

The temperature chart example shown below is displayed at 5-minute trend time (as chosen in the above screen).

To access the Lookback feature, press "PAGE LEFT" and swipe the screen to look back in time.

**Note:** The lookback period for charting is 24 hours of system "ON" time.

5. Temperature Axis
6. Trend Time
7. Selected Parameters
8. Time Axis (HR:MIN:SEC)

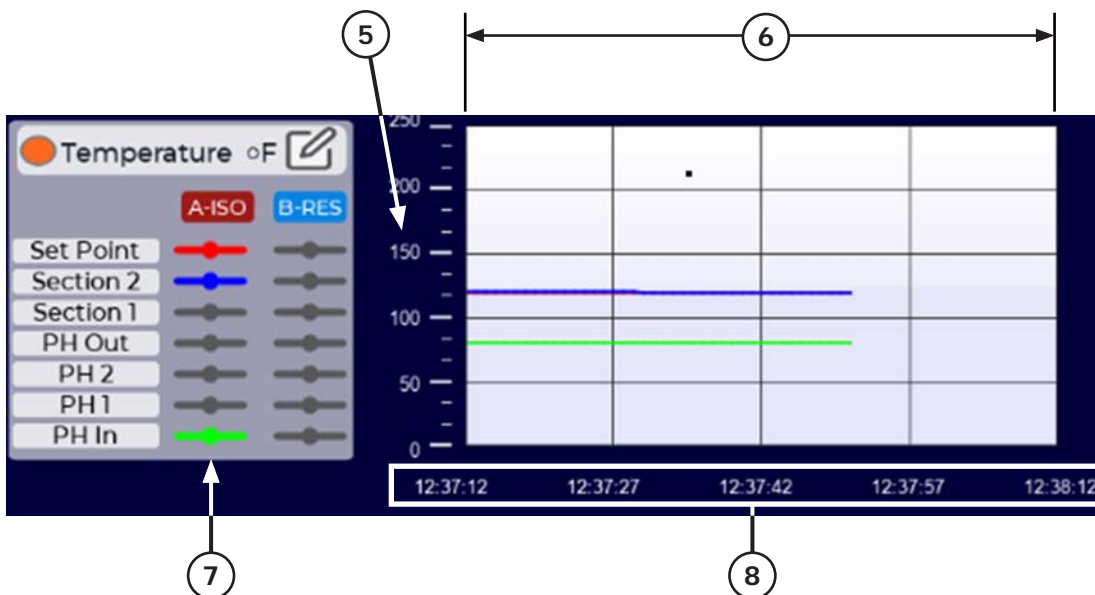



### SETTINGS SCREENS—OVERVIEW

The Settings Menu is used to access and define various systems settings.

These system settings are frequently defined at installation and not usually accessed during normal operation.

The Settings Screen is accessed from the main menu and has five sections described in the following pages.

Users must have Administrative rights to change most parameters in the Settings Screen.

1. Settings (press to open).
2. System Information
3. Configuration Settings
4. Display Settings
5. Material Functions
6. System Settings

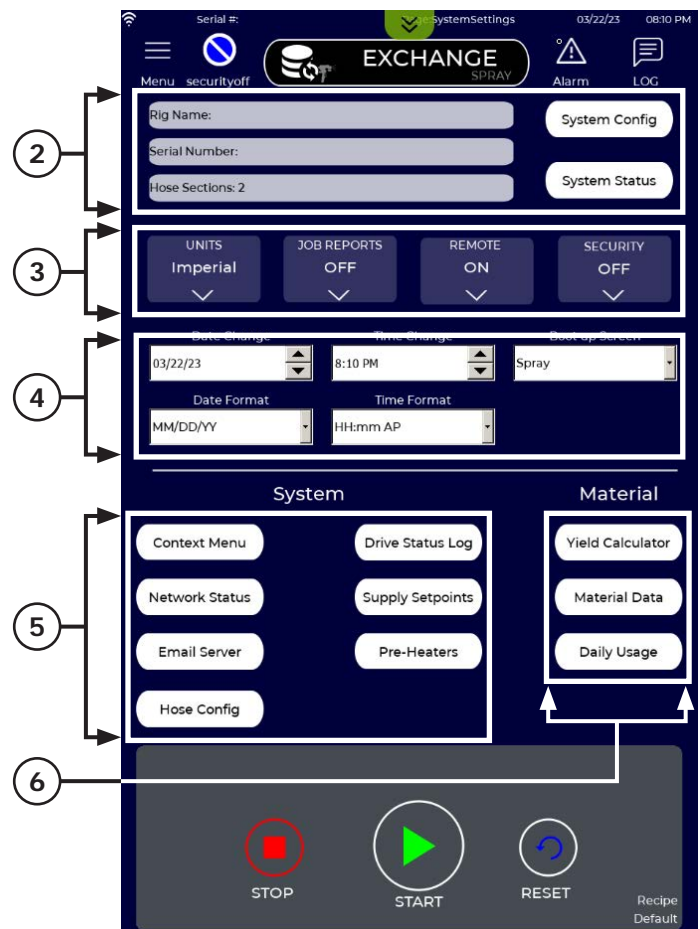

## SETTINGS SCREENS -SYSTEM INFORMATION

The System Information section of the Settings screen displays a user defined Rig Name, the Proportioner Serial Number, and the number of hose sections. The Rig Name is left to the user with administrative privileges to define.

The Serial Number is set at the factory to match the Serial number on the label inside the Control Module but can be changed by Users with Administrative privileges.

The Hose Section information is determined by the IS30 and cannot be changed by the User.

Pressing the System Config button opens a window that allows a user with administrative privileges to change Rig Name, Serial Number, and Unheated Whip Length.

Other pertinent system information (firmware versions, hose lengths, serial numbers) is shown, but cannot be changed.

Use the arrow buttons to move between pages. Firmware can be updated from a USB memory stick using the Firmware Update feature on the second page.

1. SYSTEM CONFIG (press to open).
2. System Information (press to change).
3. Press for next page.
4. Press for previous page.

**Note:** Requires administrator privileges to change settings.

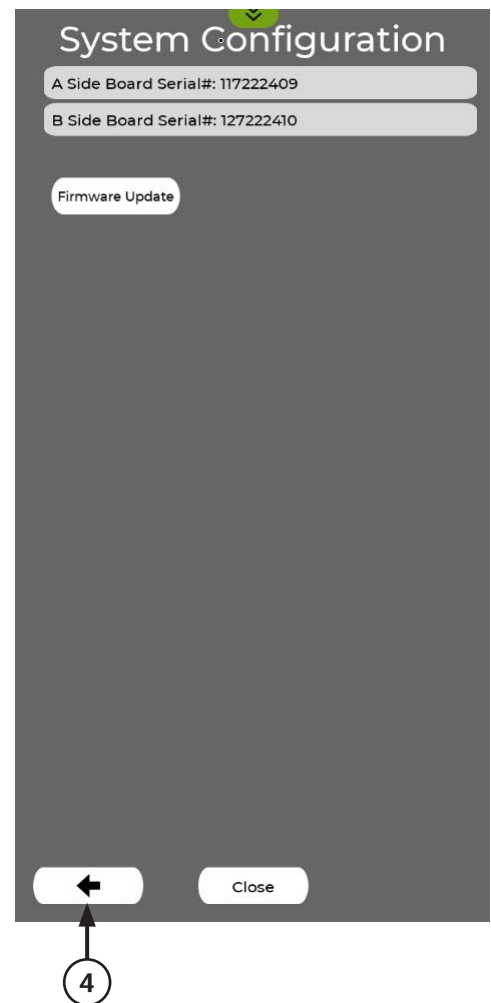
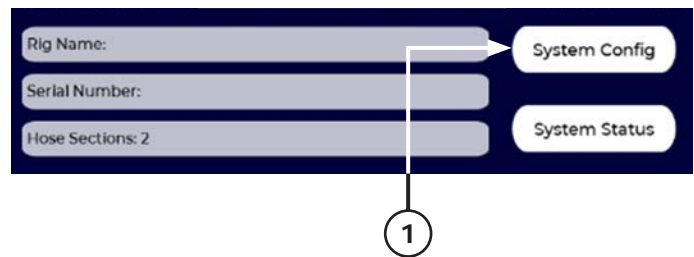

## SETTINGS SCREENS –FIRMWARE UPDATES

From time-to-time, Carlisle Fluid Technologies releases updates to the IS30 and/or QuickHeat Hose Firmware.

These updates add capabilities and fixes for have been reported by users or identified from internal testing.

Firmware updates are provided on USB memory sticks and are available from authorized IntelliSpray Distributors or from Carlisle Fluid Technologies.

Before performing a Firmware update plug the USB memory stick into the port on the side of the Control Module.

Next, select the option from the System Information screen (see "SETTINGS SCREENS-SYSTEM INFORMATION"). The Firmware Manager window will appear.

Press the Install button to begin updating. Firmware updates by USB stick take several minutes. When completed a message will provided indicating the update was successful.

If a USB memory stick with Firmware is not plugged into the external USB port on the side of the Control Module, the following "No USB Detected" dialog box will appear as shown in the figure below:

### Firmware Manager

	Current Version	Target Version	
IS30:	IS30.V401.1.3.B8		
Master Modem:	2602352	2582286	Update
Mid Modem:	2602354	2582288	Update
End Modem:	2602353	2582287	Update
A Fluid Module:			
B Fluid Module:			

Close
No USB Detected

## SETTINGS SCREENS—SYSTEM STATUS

Pressing the System Status displays total System On time and A (Isocyanate) and B (Resin) fluid used over the life of the IS30.

A and B fluid trip counters are also shown.

Available RAM (Random Access Memory) is also shown in Bytes. The IS30 has 8 GB (Gigabytes) of available memory.

The fluid trip counters are independent from the Gallons Sprayed counters shown on the Spray Screen. Fluid Trip counters are helpful for monitoring material usage over any user-defined period (e.g. multiple jobs, yield measurements, local area material usage, etc).

The counters can be reset by pressing and holding the Reset buttons shown.

The screenshot displays the 'System Status' screen with the following data:

System On:	236.0 Hrs	
System Total:	74.9 Gal	
A-ISO Total:	37.5 Gal	
B-RES Total:	37.4 Gal	
A-ISO Trip:	0.0 Gal	Press / Hold to Reset
B-RES Trip:	0.0 Gal	Press / Hold to Reset
Available RAM:	1663729664	

A 'Close' button is located at the bottom of the screen.

## SETTINGS SCREENS –CONFIGURATION SETTINGS

The Configuration section of the Setting Screen allows a user to define units and activate job reporting, remote access, and security controls as shown and defined below.

1. **UNITS:** Select Imperial (factory default) or Metric units for settings and display.
2. **JOB REPORTING:** Job Reporting can be toggled "ON" or "OFF" (factory default).

Refer to "SYSTEM ERRORS AND ACTIONS" for more information on Job Reports.

3. **REMOTE SERVICE:** This allows remote access by authorized persons for monitoring and/or control of the IS30.

This must be "ON" to perform remote service and/or remove control.

See "REMOTE ACCESS" for more information on Remote Service.

4. **SECURITY:** This activates user security controls. When Security is "OFF", any uses can change settings on the proportioner.

When Security is "ON", users must log into the proportioner and access to some actions is restricted to users with administrative privileges.

See "SECURITY" for instructions on managing.

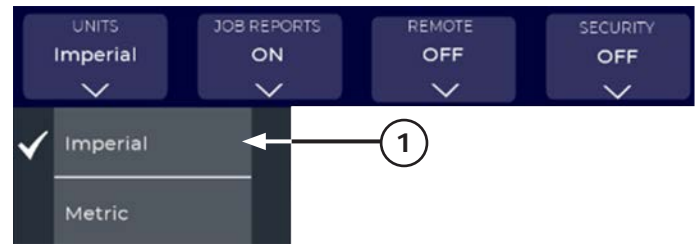

CONFIGURATION SETTINGS		
Unit	Imperial	Metric
Temperature	°F (Fahrenheit)	°C (Centigrade)
Pressure	PSI (Pounds per Square Inch)	Bar
Volume	G (Gallon)	L (Liter)
Flow Rate	GPM (Gallons Per Minute)	LPM (Liters per Minute)

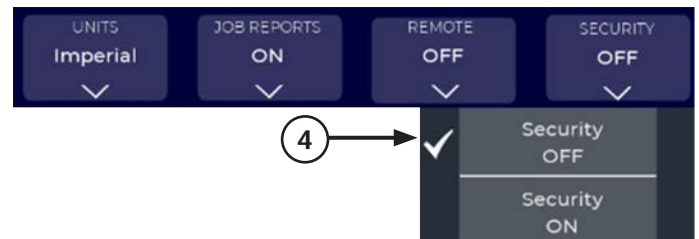
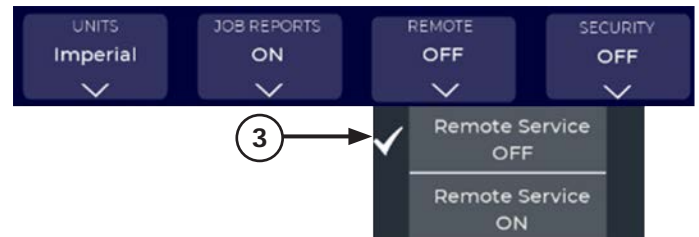

**SETTINGS SCREENS—DISPLAY SETTINGS**

The Display section of the Setting Screen allows a user to set date and time values and format, and default boot-up screen.

The Spray screen is the factory default boot-up screen.

The settings shown below are factory defaults, and time is set per Central Standard Time zone.

1. Change Date (click box or use arrows to enter or change).
2. Change Time (click box or use arrows to enter or change).
3. Boot Screen (pull down to select Spray or Exchange boot up screen).
4. Date Format (pull down to select).
5. Time Format (pull down to select).

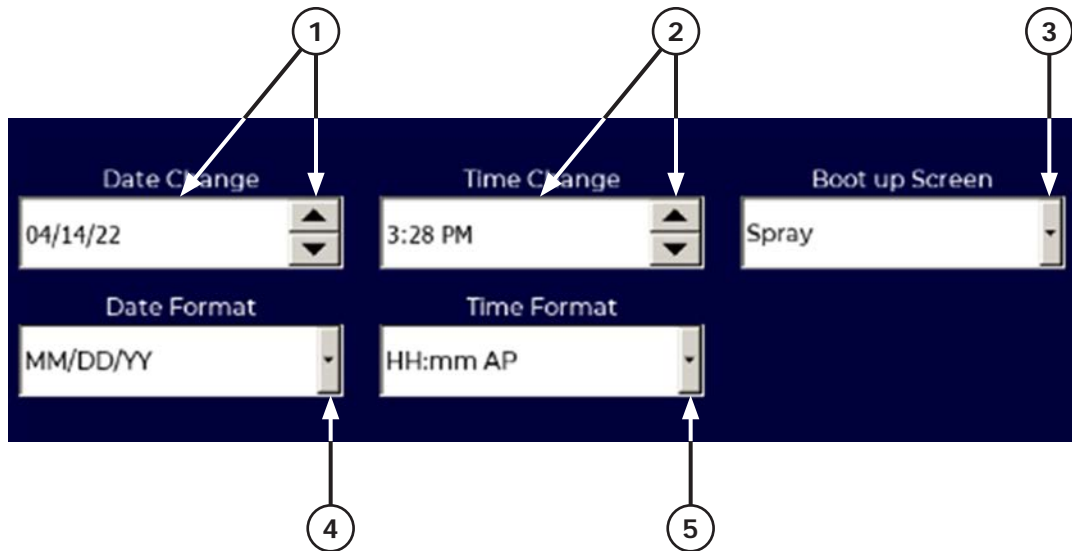



### SETTINGS SCREENS—SYSTEM SETTINGS

System settings are provided to show internal network status and for configuring both internal and external network services. Also included are hose configuration, material supply, and communication settings.

The Context Menu button accesses lower level operating system settings that may be useful in performing diagnostics. **Only trained service personnel should make changes to these settings.**

The Network Status window shows the internal connection status of all subsystems in the Proportioner and Hose. This can be helpful when performing local or remote diagnostics.

The Network Adapter Parameter window provides information on how the proportioner is communicating over wireless or connected networks. These parameters are set at the factory and should not be changed without assistance from trained service personnel.

The Email Server Setup window (shown below) is used to configure the IS30 for emailing Job Reports. Most systems are preconfigured using a generic SMTP email server managed by Carlisle Fluid Technologies. Users can change the parameters to use their own SMTP server.

Email server parameters can be restored to factory defaults by pressing the Factory Default button for 3 or more seconds.

1. Context Menu (press to open).
2. Network Status (press to open).
3. Email Server (press to open).
4. Network Status
5. Factory Default (press to reset).

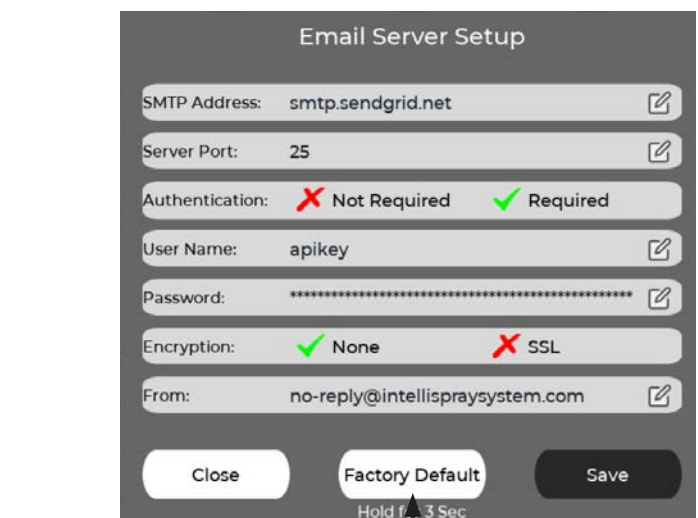
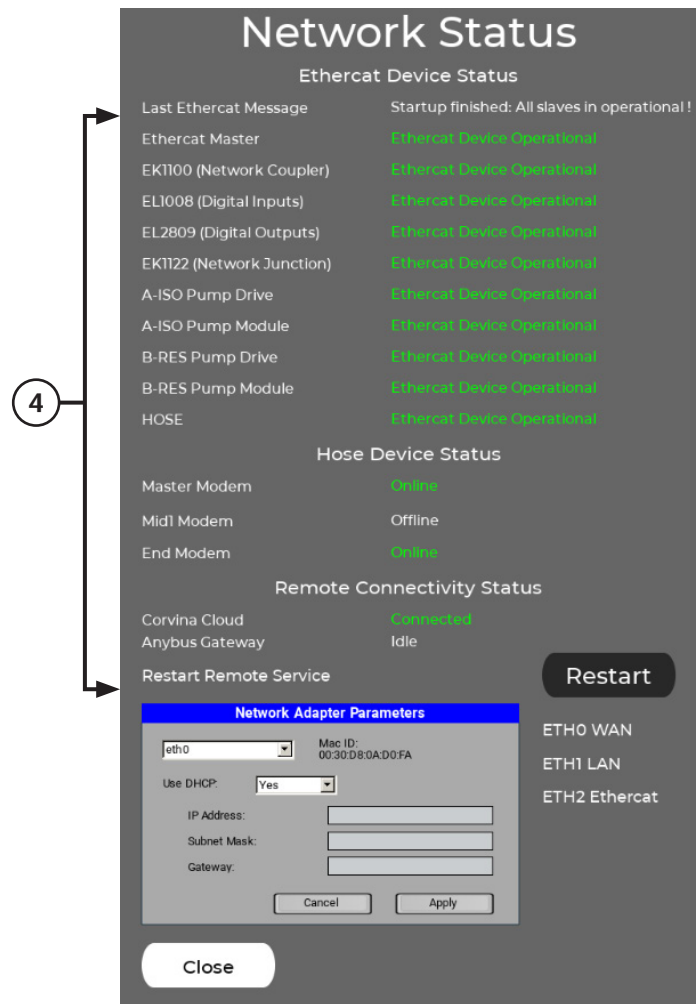
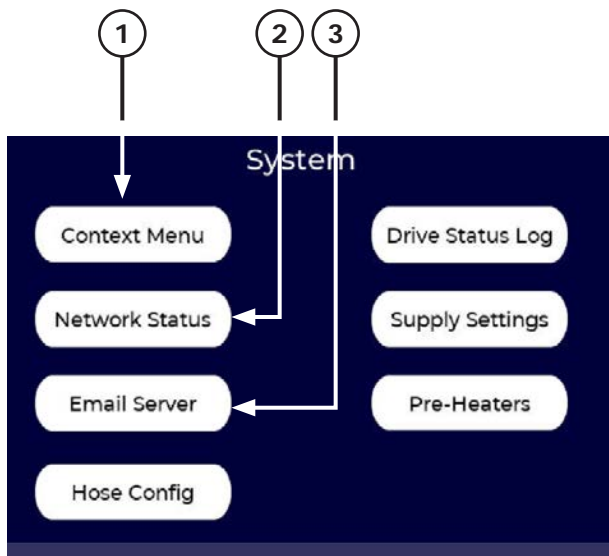

**SETTINGS SCREENS  
–HOSE CONFIGURATION**

Hose Configuration parameters are set at the factory when the Proportioner and Hoses are ordered together but can be changed as required during installation, repair, or operation.

To access Hose Configuration Parameters, press the Hose Config button: Pressing the Hose Config button will open a menu of Configuration setting tools. Press the corresponding button to access each Hose Configuration function. The Frequency button opens the Hose Frequency scan and select function (shown on the following page).

Pressure, sensor, and other signals are transmitted at high frequency between mid, end, and master modems over the hose power and communication layer.

QuickHeat hoses can operate at one of 15 different frequencies to avoid interference with other systems and interference produced in the work area. Think of each Frequency as a radio channel. Some channels may have better reception than others.

The IS30 allows the user to select the best Frequency (channel) for their particular system configuration and environment. A default frequency is set in the factory, but may need to be changed during installation, hose replacement, or if interference is detected while in use.

If a system is detecting poor hose communication an error message is displayed and the IS30 automatically moves to a STOP state. This is to prevent an overpressure or overtemperature hose situation. Any hose communication error begins with "SMOSE—Mx". SMOSE is derived from the term "Smart HOSE", and x indicates which hose modem is reporting the error, e.g. MM—Master Modem, M1 = Middle Modem, ME = End Modem).

Pressing the "RESET" and "START" buttons on the main screen may eliminate the hose error(s), but if they persist a different hose frequency is likely required.

1. Hose Config (press to open).
2. Outer Moisture Resistant Layer
3. Inner Moisture Resistant Layer
4. Inner Core
5. Power and Communication Layer
6. Woven Reinforcement Layer
7. Hose Communication Frequency (press to scan and

select hose communication frequency).

8. Hose Sections (press to specify the number and type of hose sections).
9. Hose Pressure Calibration (press to calibrate sensor).

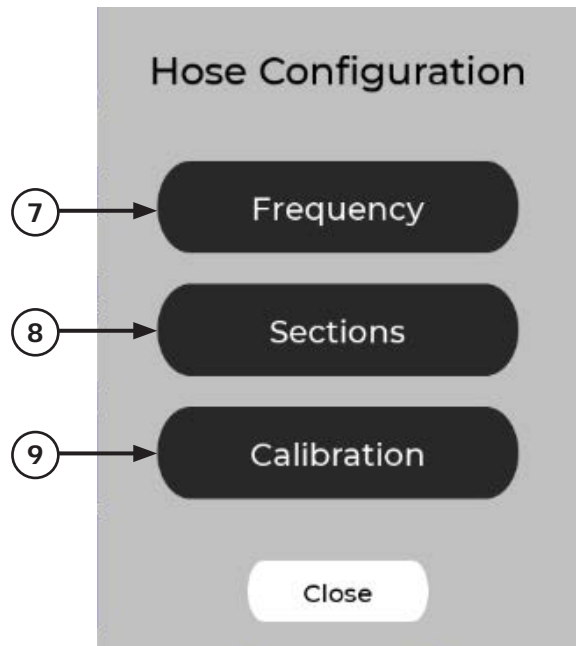
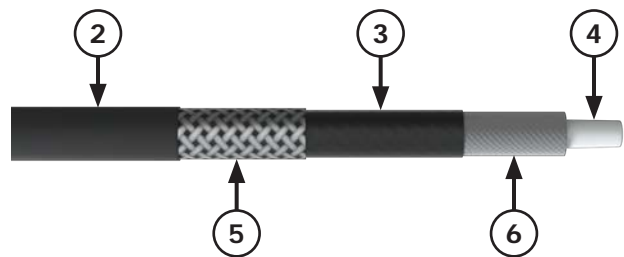
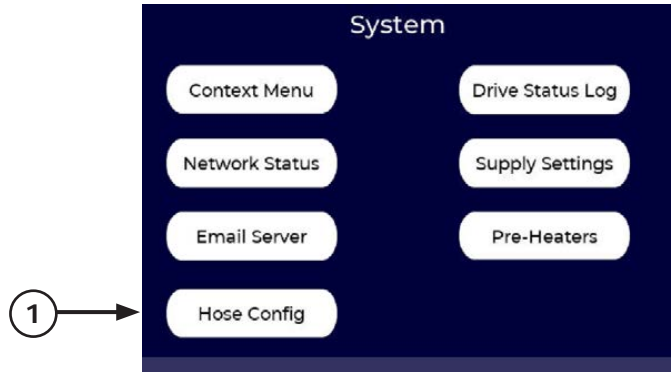

Before changing any Hose Configurations, the system must be in "STOP" state. A warning will appear if changes are attempted when not in "STOP" state.

Pressing the Hose Configuration Frequency button will open the Hose Frequency menu.

To initiate a scan, press the Scan button. Scanning all frequencies takes approximately 45 seconds. As the scan progresses, Advised (good) Frequencies will be indicated by a green checkmark ✓ to the right of the Frequency.

Frequencies with poor communication will be indicated by a red ✗ mark. See the example of the completed scan results in the figure at the right.

To change to a different Advised Frequency, press the Set button next to that Frequency.

Before initiating another scan press Clear, and when finished, press the Close button.

If there are no Advised frequencies, press the help button at the bottom of the screen. This will provide instructions on how to reset the frequency to factory default.

1. Scan Frequencies (press to initiate).
2. Clear Button (press to clear).
3. Selected Hose (indicated with a green checkmark).
4. Factory Default Reset Information
5. Set Button (press to set new frequency).
6. Close Button (press to close).

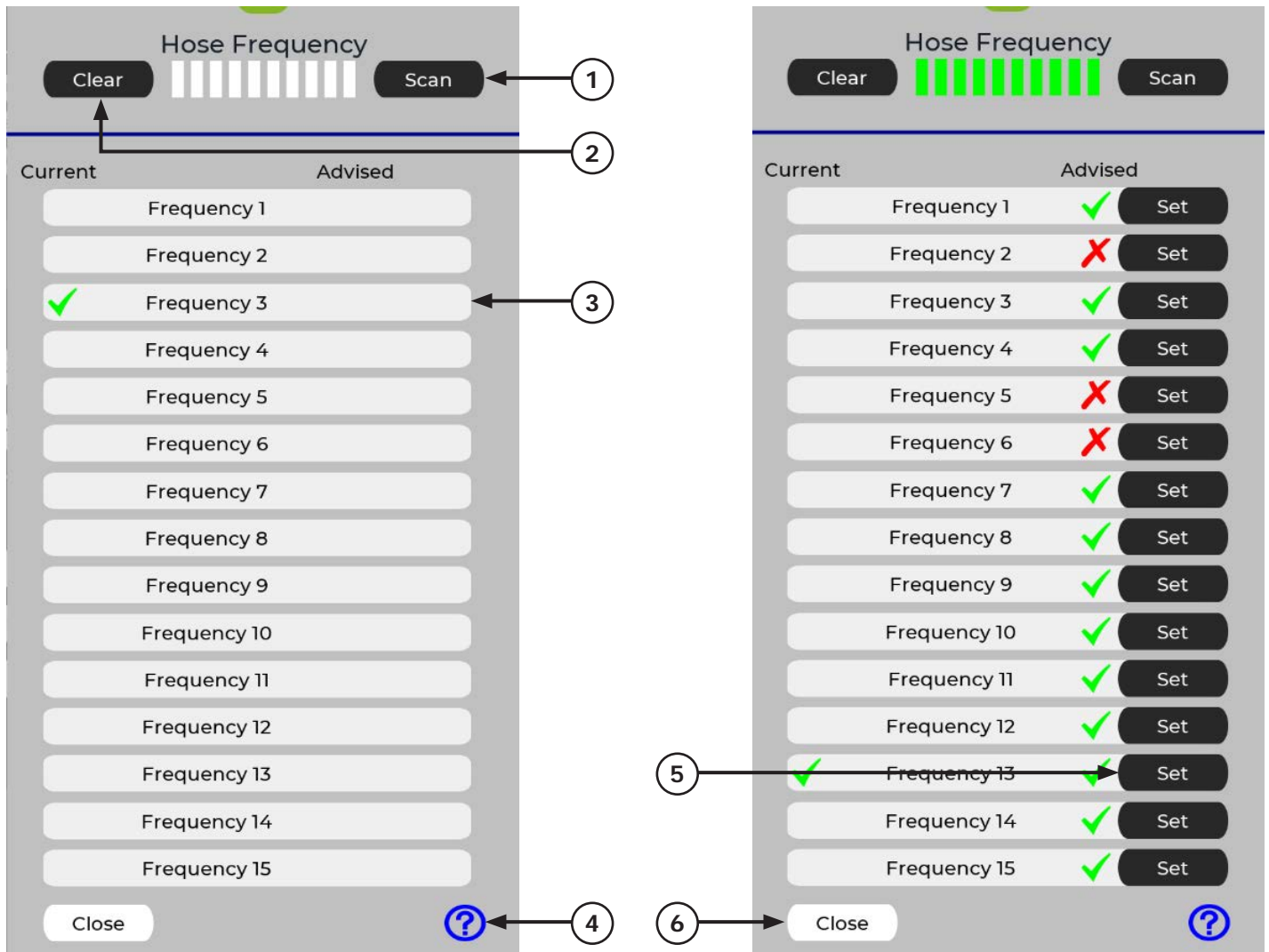

Pressing the Sections button opens a submenu that is used to select the configuration of the hoses connected to the Proportioner.

The hose configuration is set at the factory for Proportioners that are preconfigured with the hose assembly. If an existing hose assembly is changed in the field (e.g. a mid-section added or removed) the corresponding configuration must be set. The current configuration is indicated by a green checkmark as shown in the figure.

Hose configuration terminology:

MM = Master section (nearest the Proportioner)

M1 = First Mid hose section

EM = End section (also known as smart end)

The Hose Configuration menu also contains modem pairing status and pairing and unpairing functions. Pairing of modems is performed at the factory prior to shipping when the Proportioner and hoses are ordered together. If hoses or hose sections are replaced in the field, the modems will need to be paired.

Pairing of the individual hose modems helps avoid cross-talk with other QuickHeat hoses and Proportioners in the area.

Paired modems are indicated by a green checkmark ✓. If a modem is not paired a red ✗ will be shown next to the modem. Pressing the Pair Modems button will initiate the pairing operation. Only pair modems when the system is already communicating on a valid frequency and all other IntelliSpray systems in the area are shut off.

After performing hose pairing, perform a frequency scan to be sure the selected frequency is an Advised frequency.

1. Sections Button (press to open hose configuration).
2. Hose Config (displays selected hose).
3. Hose Config Set (press to set new hose).
4. Unpair Modems (press to unpair).
5. Pairing Status (displays current status).
6. Pair Modems (press to pair modems).

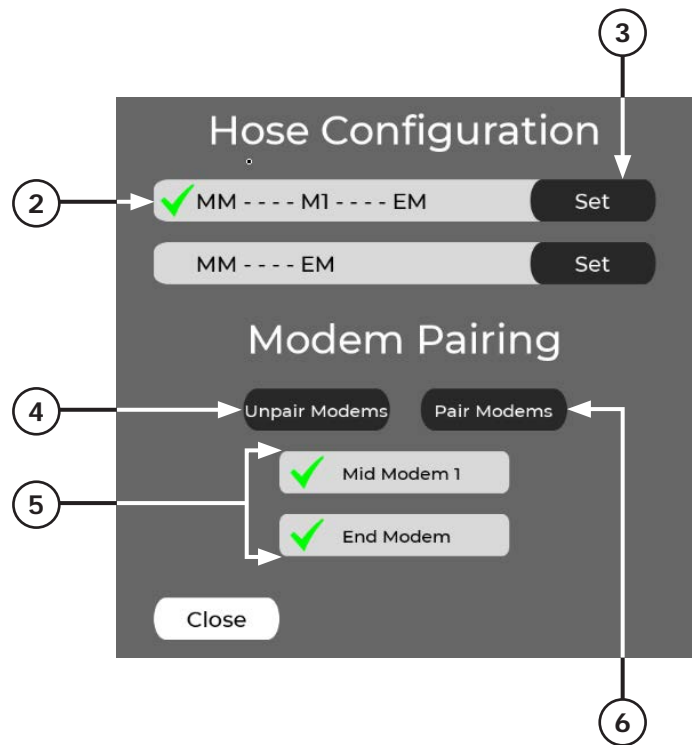
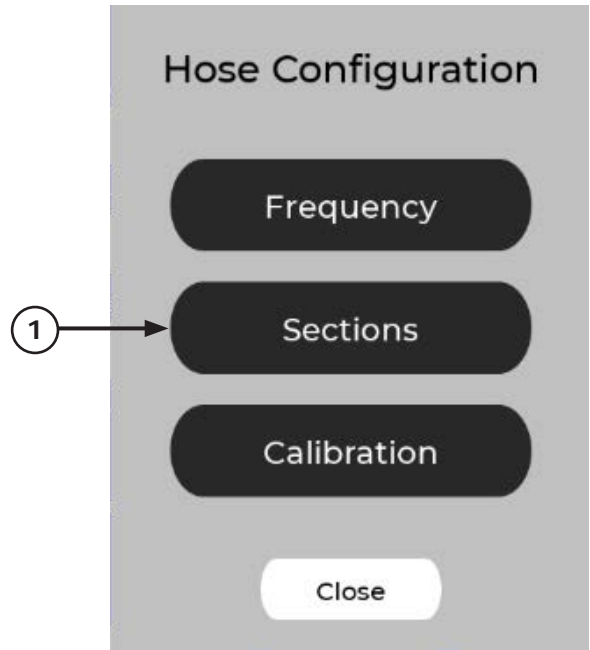

The Hose Configuration Calibration function is used to check and/or calibrate the Hose and Proportioner pressure sensors. This calibration is performed prior to shipment on systems that are ordered together. If a hose Smart End is changed in the field, or if drift is detected between the pressure sensors, they can be recalibrated in the field with this function.

Pressing the Calibration button opens the Hose Calibration tool shown below. The Hose Calibration window shows the measured pressure values at the outlet of the gear pumps (post gear pump) and at the Smart End hose modem (hose end).

The difference (delta) between the two sensors is also shown for A and B materials, respectively. When no fluid is flowing, the difference should be less than +/- 50 psi at pressures above 600 psi.

To perform a recalibration, the post gear pump and hose pressure must be at least 600 psi. In the previous figure this condition has not been satisfied and calibration is prevented. Once pressure is established, and the system is in STOP state, calibration of the A or B-side can be performed by pressing the corresponding Calibration button. After calibration the difference between the sensors will be very close to 0.

1. Calibration Button (press to open calibration).
2. A-ISO Pressure Calibration Pressure Display
3. B-RES Pressure Calibration Pressure Display

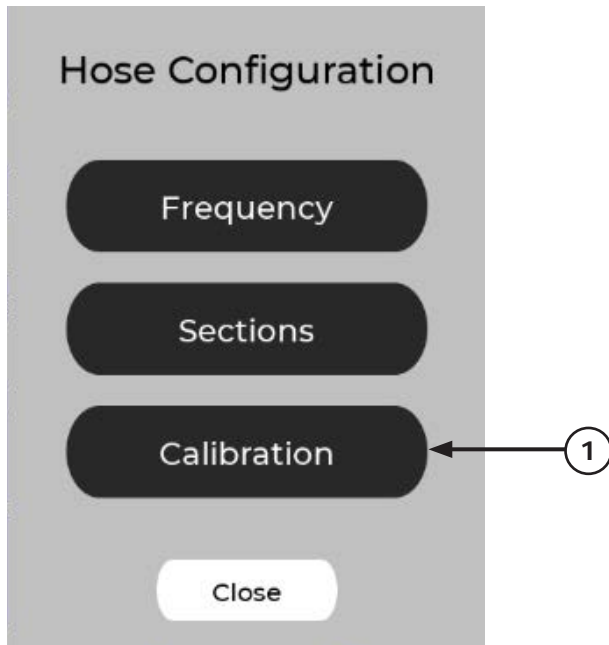

4. A-ISO Pressure Calibration (press to open).
5. B-RES Pressure Calibration (press to open).
6. A-ISO Delta Pressure
7. B-RES Delta Pressure

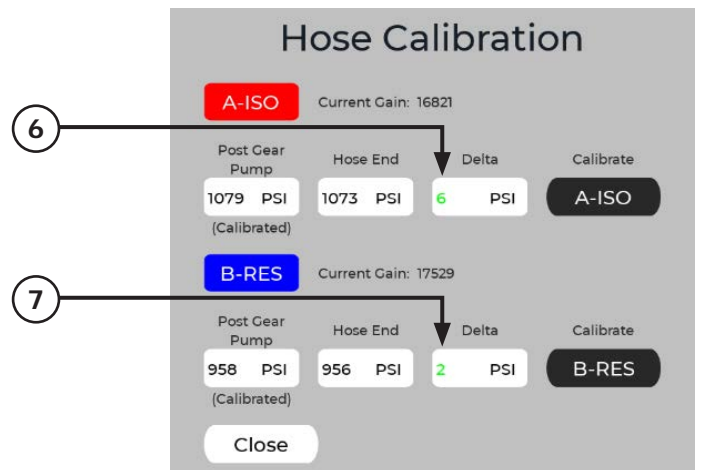
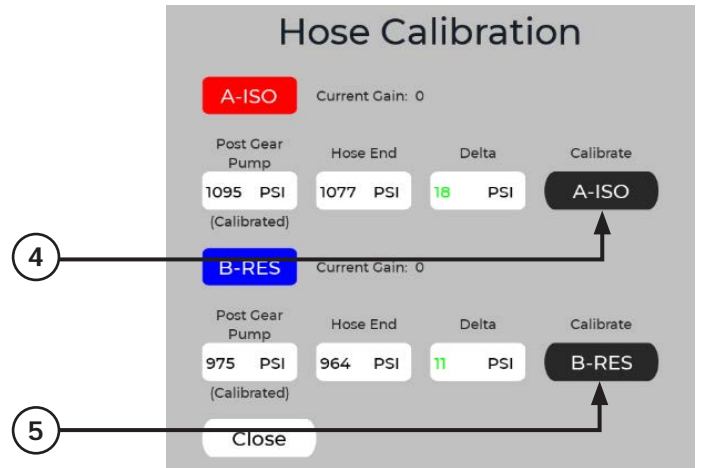
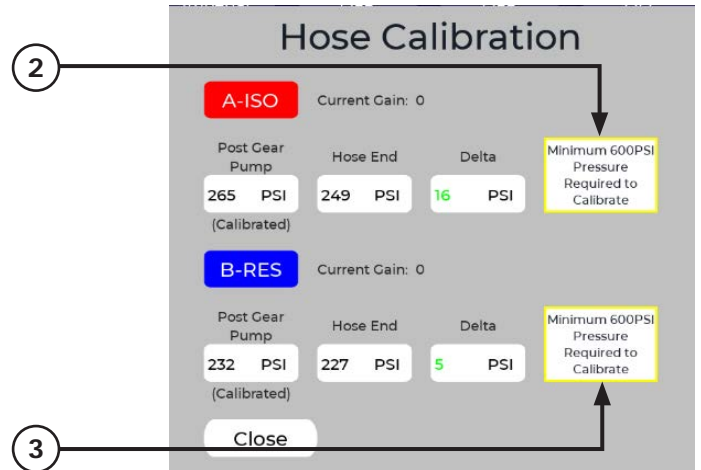



### SETTINGS SCREENS—DRIVE STATUS LOG

The Drive Status Log button provides detailed information about the A or B motor drive controllers. This Log is a history of motor drive states, errors, and actions.

If a driver error occurs, a generic message will be presented to the user on the active screen, and logged in the active errors in the Alarm screen (see "ALARM SCREEN").

The Drive Status Log provides more specific drive codes that can be useful when performing diagnostics.

The Drive Status Log retains up to 100 past log entries. Use the scroll bar, or swipe vertically to move through the entries.

1. Drive Status Log (press to open).
2. A Drive Status Display
3. To B Side Drive Log (press to open).
4. B Drive Status Display
5. To A Side Drive Log (press to open).

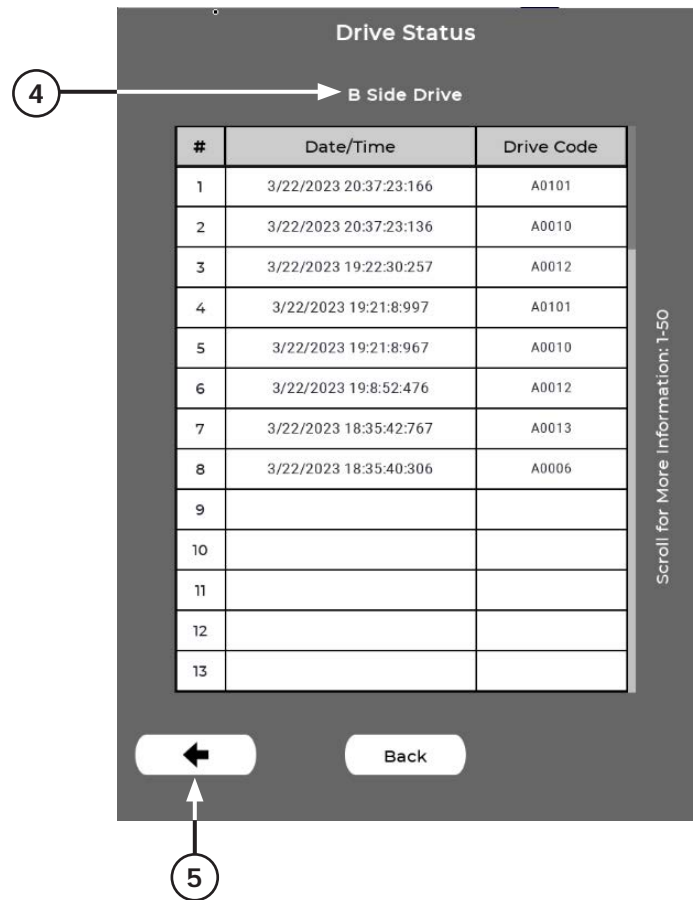
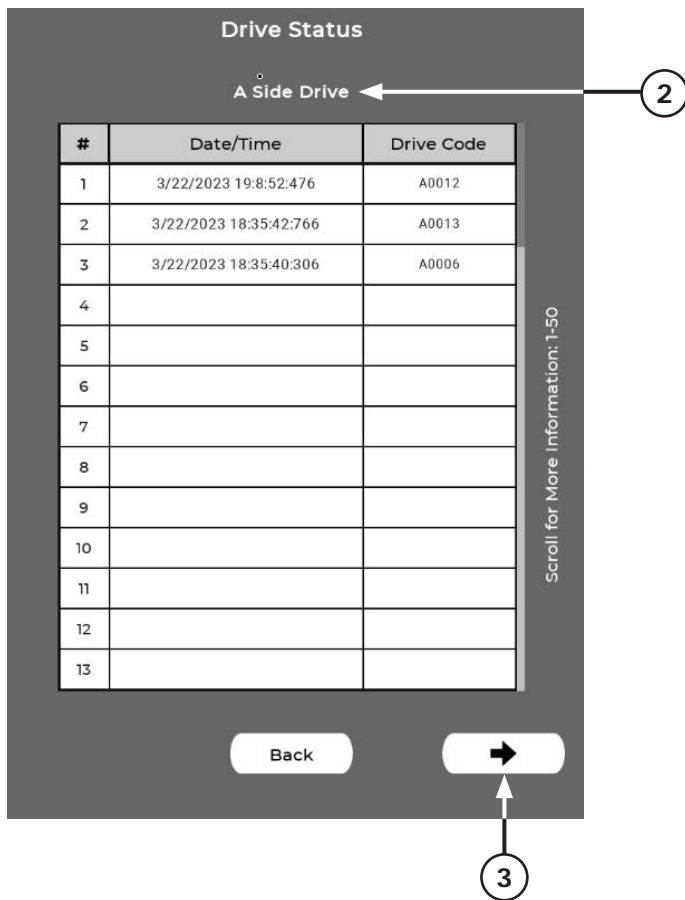
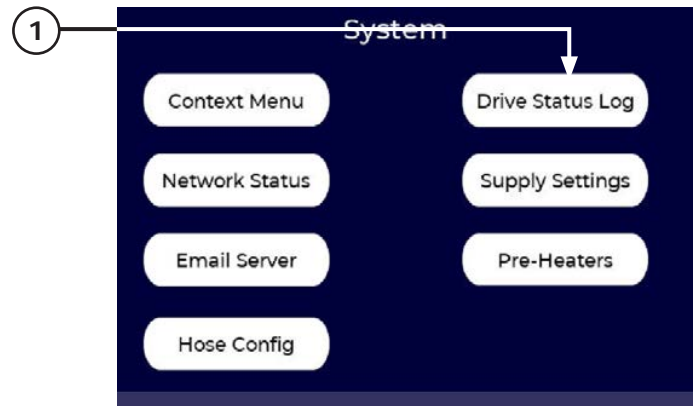



### SETTINGS SCREENS—SUPPLY SETTINGS

The **Supply Settings** function is used to define drum or tote size, as well as A and B-side inlet pressure warning and error limits.

These settings protect the IS30 from situations that could damage the equipment and/or inject air into the proportioner and hoses. Values can be changed from factory default settings using a pop-up keyboard.

Low drum warning level. A and B materials can be set separately. Press to enter value. Drum icon flashes yellow when fluid drops to warning level. Factory setting is 5 gallons. If set to 0 gallons warning is turned off.

Inlet high pressure error limit. Applies to both A and B materials. System generates error message and shuts down if exceeded. Maximum setting is 300 psi (20.4 bar).

Inlet high pressure warning limit. Applies to both A and B materials. System generates warning message if exceeded. Maximum setting is 300 psi (20.4 bar).

Low drum error level. A and B materials can be set separately. Press to enter value. Drum icon flashes red and system shuts down when fluid drops to error level. Factory setting is 3 gallons.

Standard drum size. Press to enter value. This is used for scaling fluid level on drum icons. Factory setting is 55 gallons (208 liters).

Inlet low pressure error limit. Applies to A and B sensors before the gear pumps.

The system generates an error message and stops if pressure drops below setting. The minimum pressure setting is 25 psi (1.7 bar).

Inlet low pressure warning limit. Applies to A and B sensors before the gear pumps. The system generates a warning message if the pressure drops below a setting. The minimum pressure setting is 0 psi (0 bar).

1. Supply Settings (press to open).
2. Low Drum Warning Level
3. Low Drum Error Level
4. Standard Drum Size
5. Inlet High Pressure Error Limit
6. Inlet Low Pressure Error Limit
7. Inlet Low Pressure Warning Limit
8. Inlet High Pressure Warning Limit

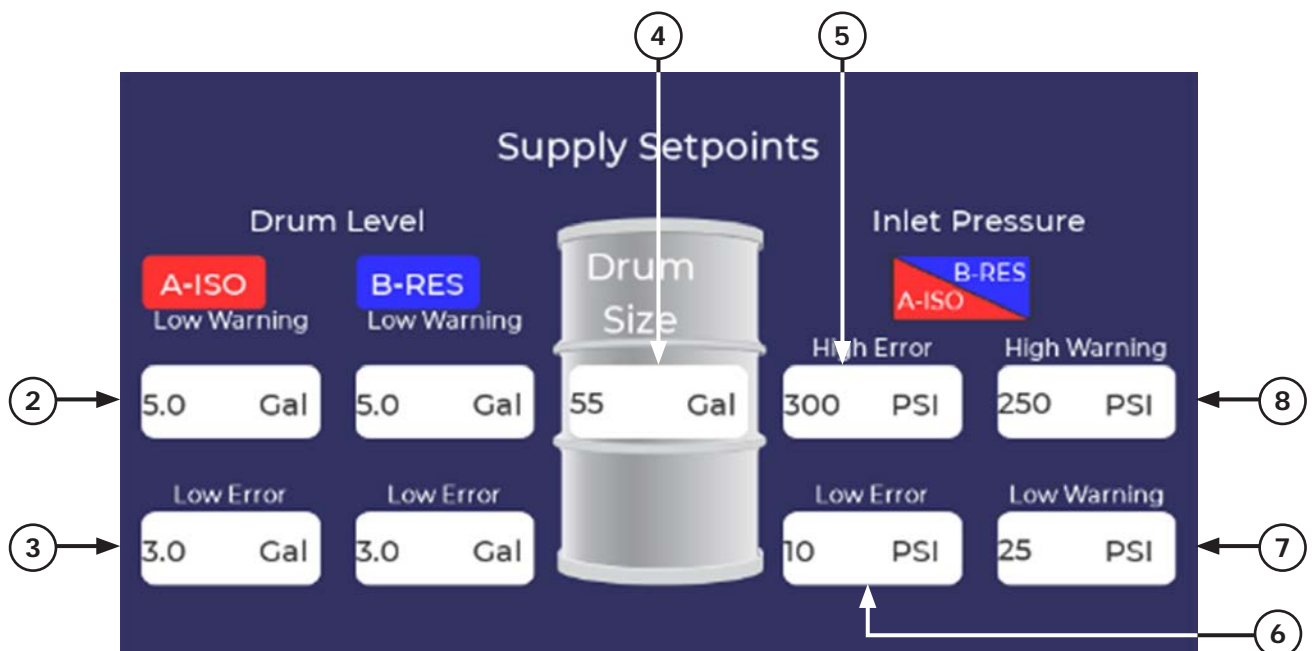
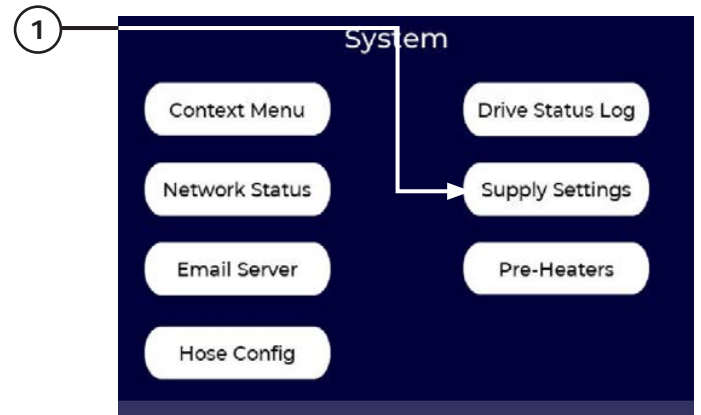

## SETTINGS SCREENS—PRE-HEATERS

The IS30 is shipped with one preheater in each fluid module. The proportioner can be field upgraded from one to two preheaters per fluid module.

Adding a second preheater will increase the heating power and temperature rise through the preheaters, which can reduce drum conditioning times or provide more heating power when operating with a shorter distribution hose.

Contact an authorized IntelliSpray distributor or service provider to learn more about this option.

If a second preheater is installed on the A and/or B fluid modules, the proportioner must be reconfigured to recognize the second preheater via the Pre-Heater button shown.

Pressing the button will open the Pre-Heater Configuration menu. The normal configuration is one (primary) preheater per fluid module. This is indicated by the green checkmark ✓ as shown.

If a secondary preheater has been installed, it must be enabled by pressing on the corresponding red ✗ marks in the Pre-Heater Configuration menu. This will indicate to the Control Module that a secondary preheater has been installed.

After making changes, press the Save button before exiting the menu.

It is also possible to install a secondary preheater on only one fluid module (normally the B-side), or even remove a primary preheater when not required. In that case, only activate the preheater(s) that are installed.

1. Pre-Heater Configuration (press to open).
2. Single Preheater Configuration
3. Two Preheater Configuration

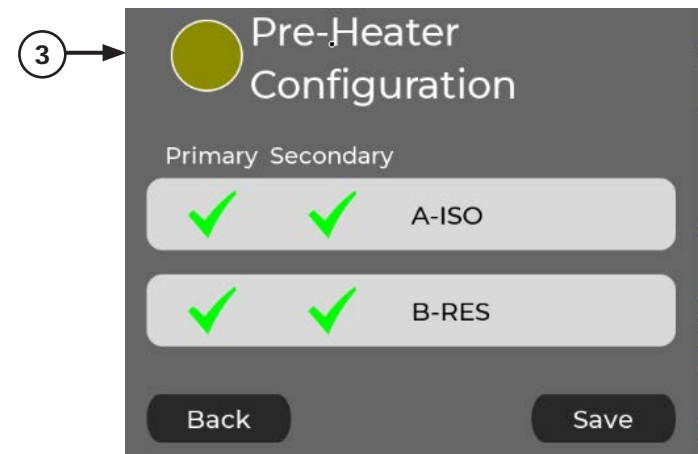
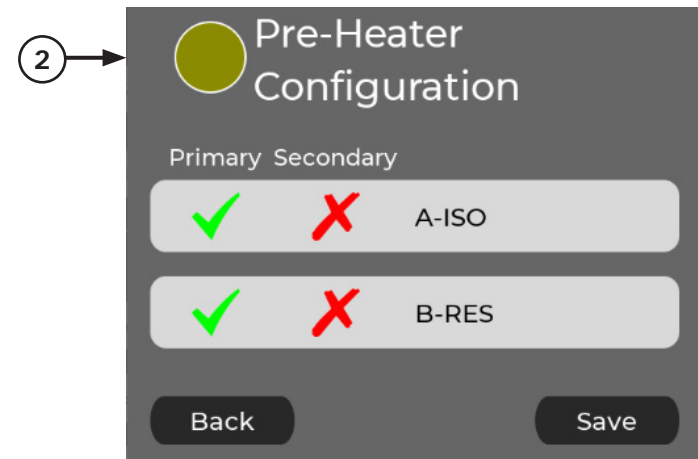
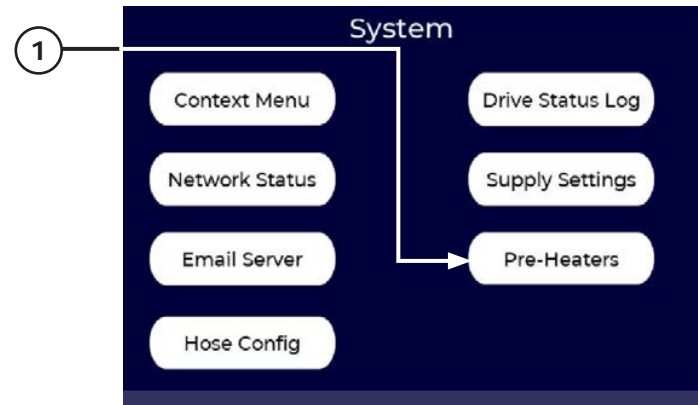

## SETTINGS SCREENS—YIELD CALCULATOR

The Material section of Settings Screen is used to access a Yield Calculator and a Material library for defining, editing, exporting and importing A (ISO) and B (Resin) information.

These optional features can be helpful when preparing comprehensive Job Reports.

The system generates an error message and stops if pressure drops below setting. The minimum pressure setting is 25 psi (1.7 bar).

The Yield Calculator is an application that automates the calculation of material yield and in-place foam density.

The output is included in the currently active Job Report.

To perform a yield calculation the user enters the size of the spray area and the average depth of foam in that area. Material data must also have been previously entered.

**Note:** The next page shows the Yield Calculator User inputs and system outputs.

The recommended procedure for performing a yield calculation is as follows:

1. Make sure the material data information has been entered and saved using the **Material Data** menu (see "SCREEN SETTINGS-MATERIAL DATA").
2. Identify a suitably large test area with regular stud, joist, or rafter spacing and little or no opening or interruptions (e.g. plumbing, electrical services, vents, etc).
3. Open the **Yield Calculator**
4. Select or define the Entry Number in the top cell using the - or + buttons.
5. OPTIONAL: Press the Time entry icon to automatically enter the system time.
6. Select the A-ISO and B-RES materials from the drop down menu (note these are defined in **Material Data** Settings).
7. OPTIONAL: Select Entry Type (Start of Job, Yield Check, End of Day, End of Job). Yield Check is the most common selection.
8. Enter Area Square Footage for the yield calculation, or use the square footage calculator (accessed by clicking the question mark icon).
9. Enter Average Foam Depth for the yield calculation or use the Foam Depth calculator

(accessed by clicking the question mark icon).

10. The total spray volume in Board Feet will be automatically calculated.
11. OPTIONAL: Skip steps 8-10 and directly enter the spray volume in Board Feet.
12. For a new yield calculation, press the Reset button (in the Gallon Counter menu section) to clear the gallon counters if non-zero.  
If continuing with a previous yield test proceed to step 11.  
If spraying of the test area is interrupted, press SAVE to store the current gallon counter values.
13. Press the "START" button and spray the test area.
14. When spraying of the test area is completed, check the total square footage and average foam depth and re-enter if it is different than the initial entry (steps 8 and 9).
15. Press the Calculate button to complete the Yield Calculation and store it in the Job Report (if Jobs function is activated).

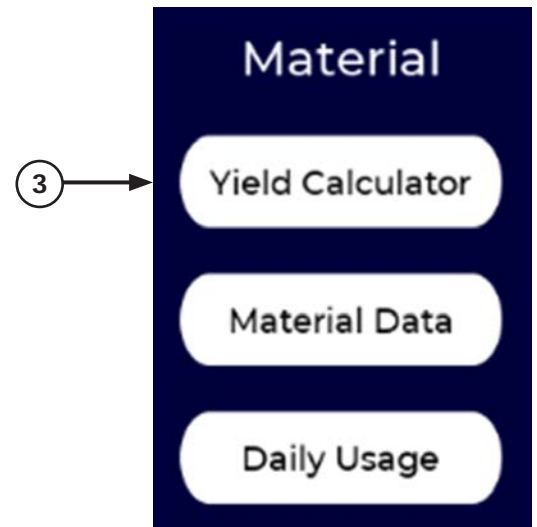

**Note:** Green items must be entered to perform a yield calculation, other input fields are optional.

**User Inputs**

1. Entry Number (press - and + buttons to select the entry number).
2. Time (press to apply the optional date and time-stamp test entry).
3. A-ISO Material (press to select).
4. B-RES Material (press to select).
5. Entry Type (press to select this option).
6. Area Square Footage (enter test area).
7. Average Foam Depth (enter average foam depth)
8. Calculated Board Feet (directly enter test area volume option).
9. START (press to initiate Gallons counters).
10. RESET (press to zero counters).
11. SAVE (press to retain counters if test is not continued in one test session).
12. Calculate (press to calculate the outputs).

**Outputs**

13. Area Calculator (press to open).
14. Depth Calculator (press to open next page).
15. A-ISO Sprayed (gal).
16. B-RES Sprayed (gal).
17. Total Gallons.
18. A:B Ratio Sprayed
19. Total Volume/Set (gal/set).
20. A Density (Lb/Gal).
21. B Density (Lb/Gal).
22. Installed Foam (Lb).
23. Yield (Bdft/Set).
24. Yield (Bdft/Gal).
25. Density (Lb/cuft).

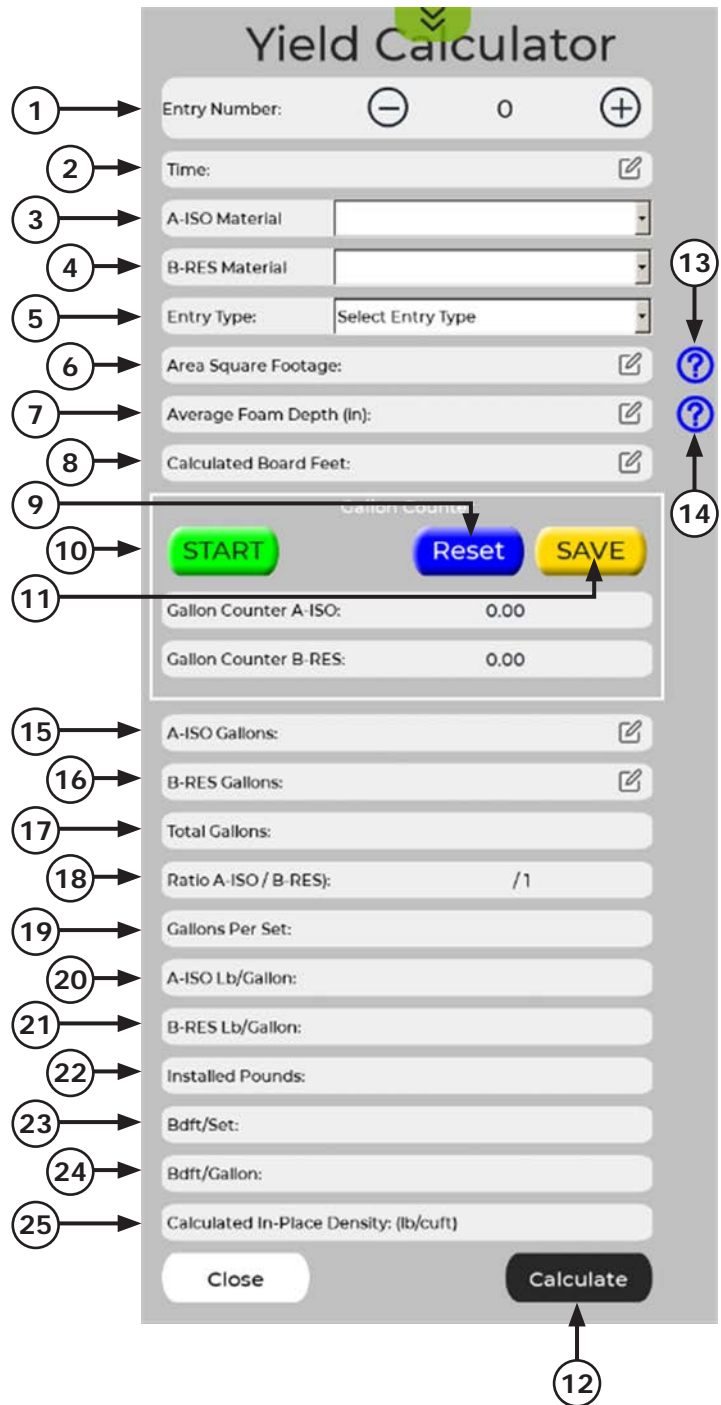

For user convenience, the Yield Calculator includes embedded calculators for determining test area and average foam thickness. This can eliminate guesswork and/or use of external hand calculators.

To access these embedded calculators press the associated question mark icon next to the respective entry.

The area calculator allows the user to enter the width and length of up to 5 separate areas (e.g. stud bays).

Press on each cell to enter the numeric values of width and length (using consistent units).

Press Clear to clear all cells.

Press Save to complete the calculation and Close to return to the Yield Calculator and automatically populate the Area value.

The Average Depth calculator allows the user to enter up to 28 depth measurements taken within the test area.

Press on each cell to enter the depth values.

Press Clear to clear all cells.

Press Save to complete the calculation.

Close to return to the Yield Calculator and automatically populate the average depth value.

1. Area Calculator (press to open).
2. Depth Calculator (press to open next page).
3. Area Dimension Cells (enter numeric values).
4. Clear (press to clear).
5. Close (press to close)
6. Save (press to save).
7. Average Depth Cells (enter numeric values).
8. Clear (press to clear).
9. Close (press to close).
10. Save (press to save).

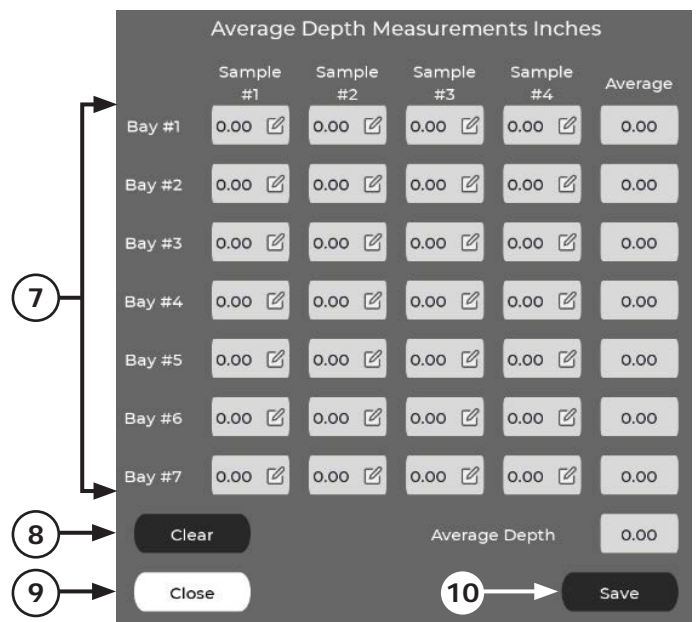
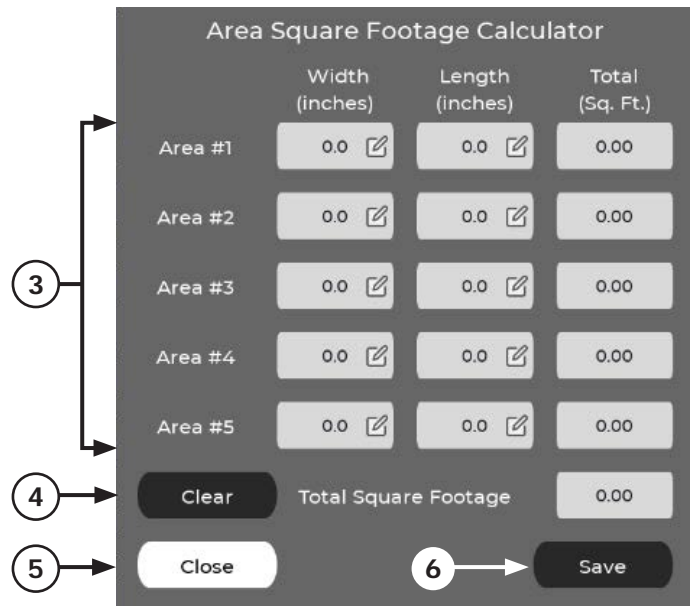
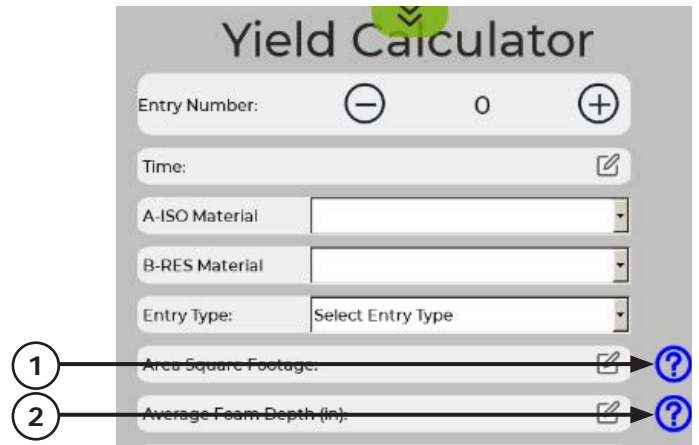



**SETTINGS SCREENS—MATERIAL DATA**

An optional Material library is also accessed via the Settings Screen. This feature allows users to define, edit, save, and delete information and properties for both A and B materials. This information is used in performing yield calculations and also simplifies information entry for Job Reporting.

To access the Material Library select **Material Data** from the Material Settings men, then select either A-ISO or B-RES material.

After selection of **A-ISO** or **B-RES** material, the user can then select the desired operation—Add a new material, Edit information about an existing material, Delete a material, and Import or Export material information via a USB storage device.

To add a new material, select **Add Material** and use the popup keypad to enter information in the fields shown below. This data can be obtained from the drum label, Product Data Sheet, or Material Data Sheet.

To edit an existing material select **Edit Material**, select the material to edit from the drop-down menu, and enter new values as required.

1. Material Data (press to open).
2. A/B Material Selection (press to select).
3. Add Material (press to open).
4. Field Selection Menu (press each to open).
5. Edit Material (press to open).
6. Material Menu (press to open menu).
7. Field Selection Menu (press each to open).

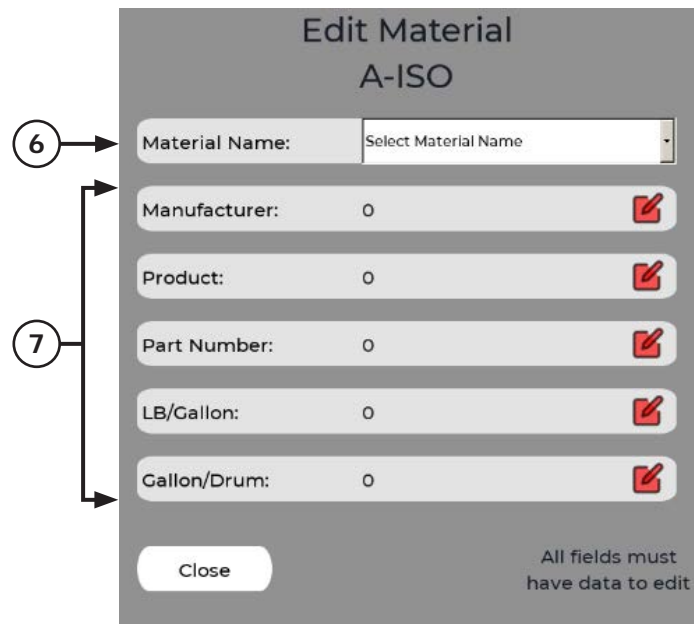
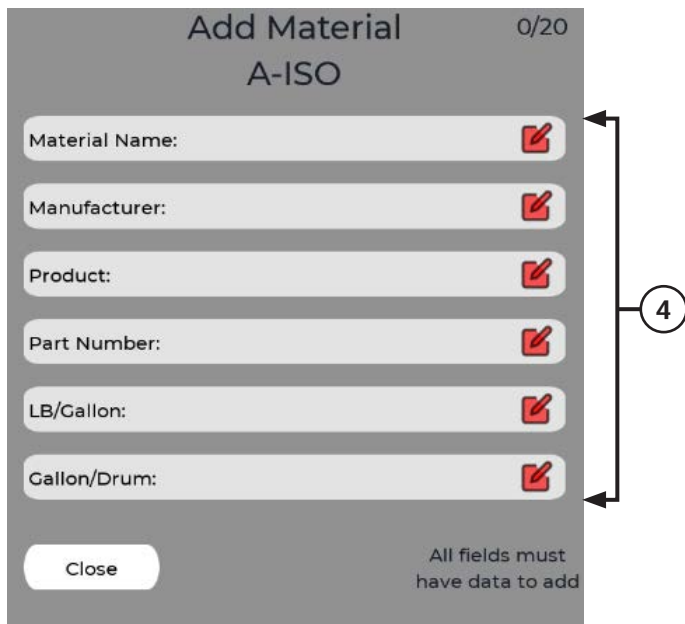
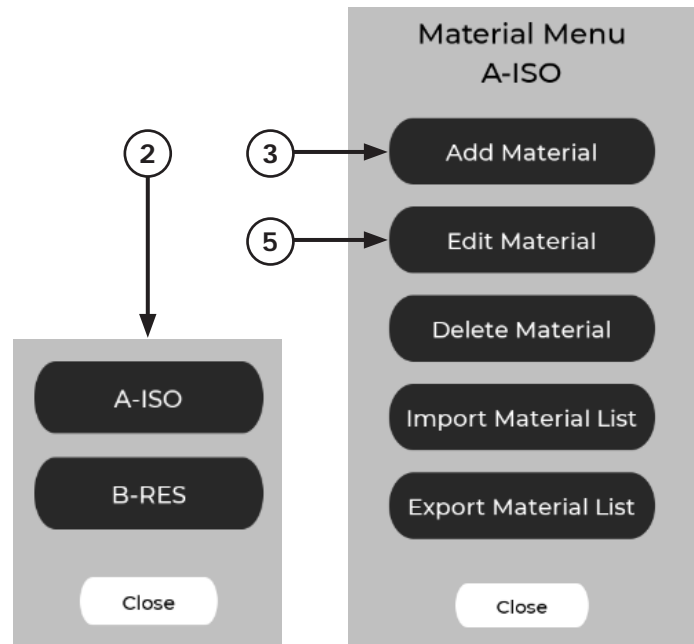
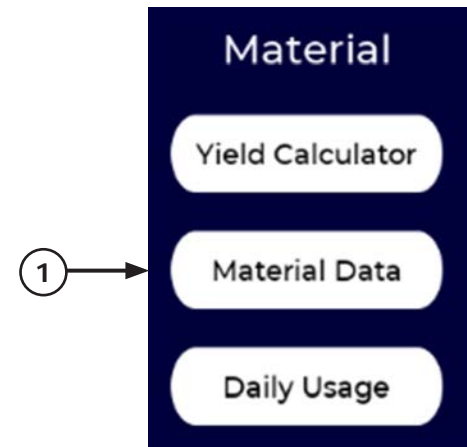



Select **Delete Material** and select from the drop-down menu to delete a material.

Select **Import Material List** to import a material or materials from a USB device attached to the unit.

Select **Export Material List** to export all materials in the material library to a USB device attached to the proportioner. This feature allows sharing information between systems.

Material Lists are in standard .csv format and can be edited remotely on the users computer. Many users create a "master" .csv file of all materials they commonly use and keep it stored on a PC for importing to their IntelliSpray Proportioner(s).

When materials have been previously defined, and Job Reporting is "ON", a user can select a material from a drop-down menu on the drum icon instead of manually entering the information.

8. Delete Material (press to delete).
9. Material Menu (press to open menu).
10. Import Material List (press to import list).
11. Import Material List Display
12. Export Material List (press to export list).
13. Export Material List Display

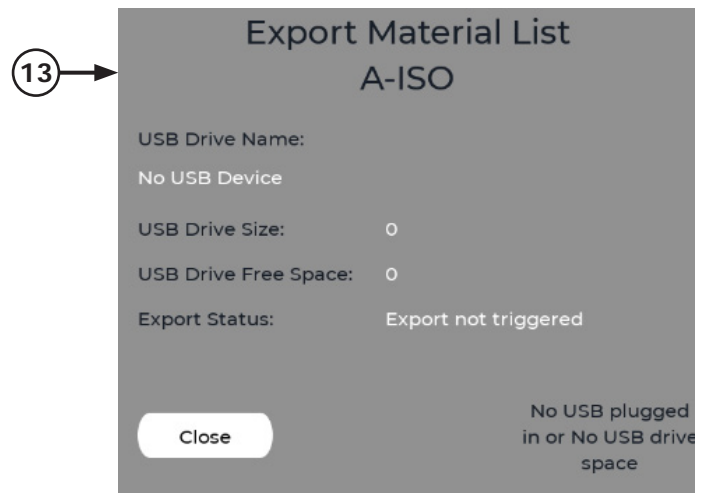
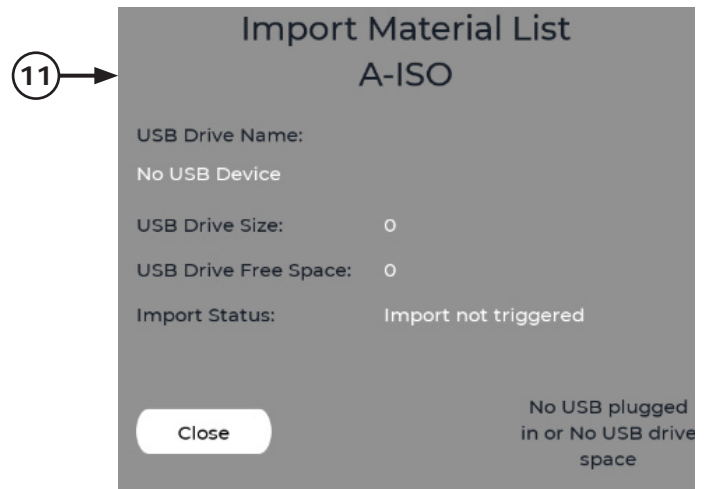
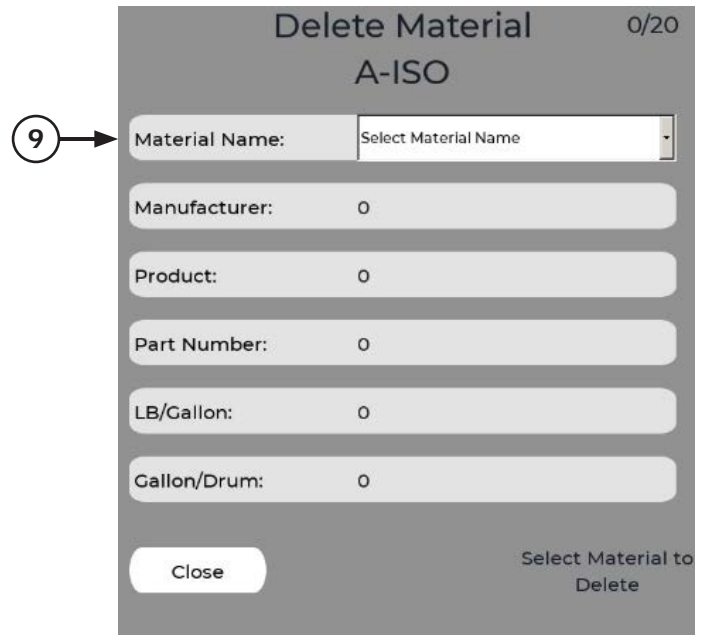
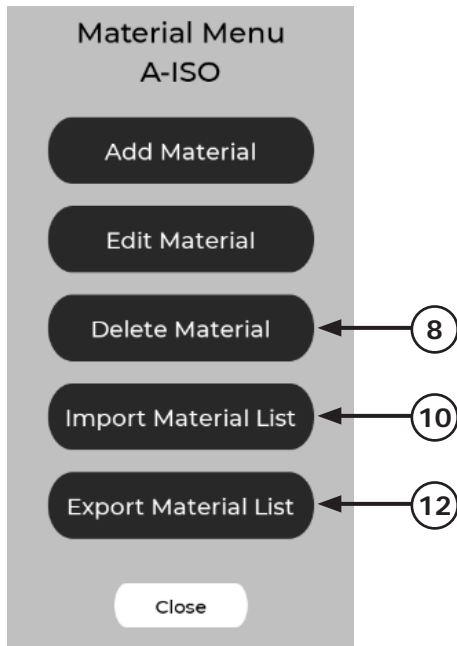

**SECURITY**

When **Security** is enabled ("ON") in the Setting Screen user access and permissions will be controlled.

Security is enabled or disabled in the **Settings Screen** as shown. Only users with administration permissions can change the setting and/or create, edit, or delete users.

When Security is "OFF" the User Icon in the upper left portion of the Proportioner screen will indicate "security off" and the User Icon will display a slash mark. When Security is enabled the User Icon will contain the initials of the currently logged on User, and the User's role will be shown below the User Icon.

When Security is "ON", the Proportioner will require the user to log-in at system start-up or after a period of inactivity, if defined.

To turn Security "ON" the user must log in under an administrative user name. All systems have three factory default users as shown in the following figure and described below.

**User Name: Admin.** Password = admin (all lower case). This predefined "Admin" user can be edited or deleted by an end-user with administrative privileges.

**User Name: CFT.** Password is hidden.

Used only by CFT service staff for performing remote diagnostics if/when required. It cannot be edited or deleted.

**User Name: SecurityOFF.** Password is hidden.

This is the default user for logging purposes when Security is turned off. It cannot be edited or deleted.

When Security is "ON", press the User Icon to access the User Management menu as shown.

1. Security Setting (press to open menu).
2. Security OFF
3. Security ON
4. User Name (press to open menu and select choice).
5. Management Menu (press to open).

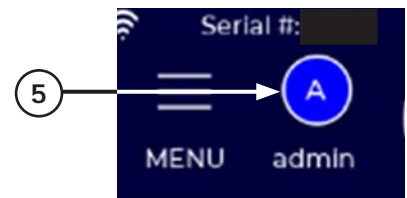
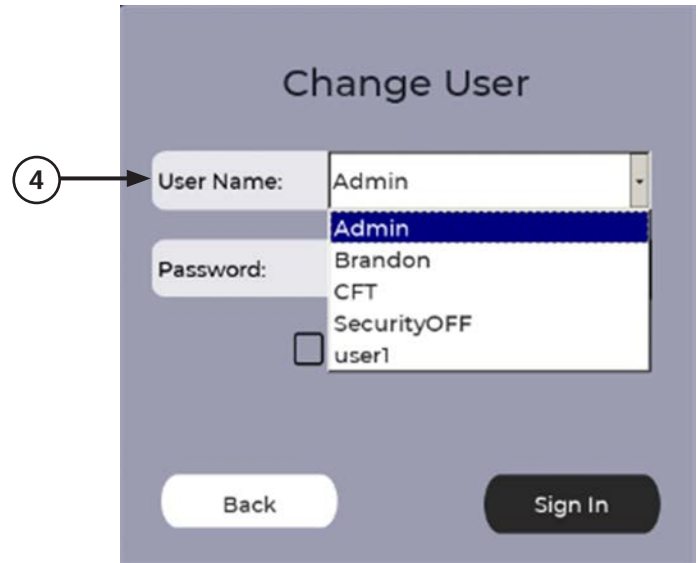
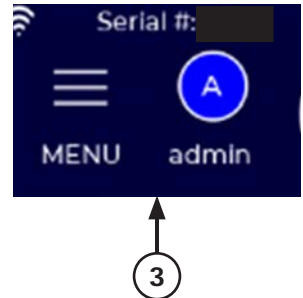
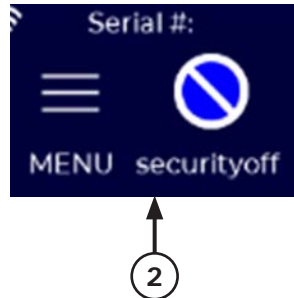
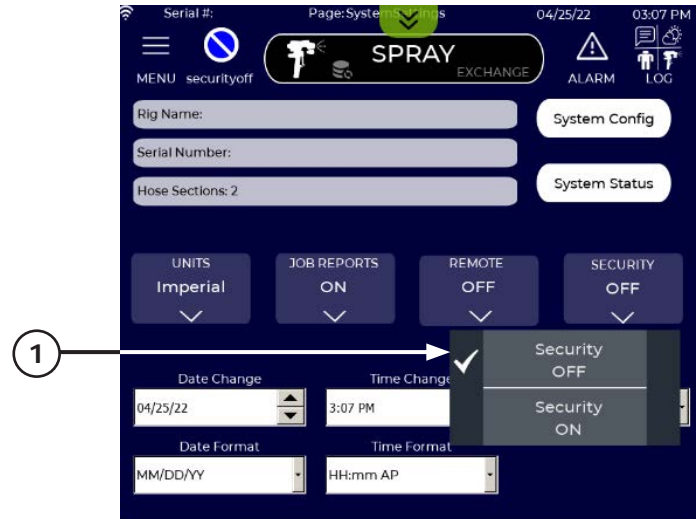

Pressing the User Icon will open the **User Management** menu.

A user with an Administrative role can switch users, change passwords, and add, edit, or delete users.

A user with a Sprayer role will only have the ability to switch user or change their own password. Other functions will be highlighted to indicate they are not accessible.

To change users, select Switch User from the menu, then select the new user to login under from the drop-down menu.

To Change a password select the new user from the drop-down menu and enter password (this will require dual entry for authentication) then press Sign In.

1. Administrator-Only Functions (press each to open).
2. Sprayer-Accessible Functions (press to open menu).
3. Sprayer-Inaccessible Functions
4. User Name (press to open menu and select choice).
5. Password (enter user or new password).
6. Sign In (press to open).

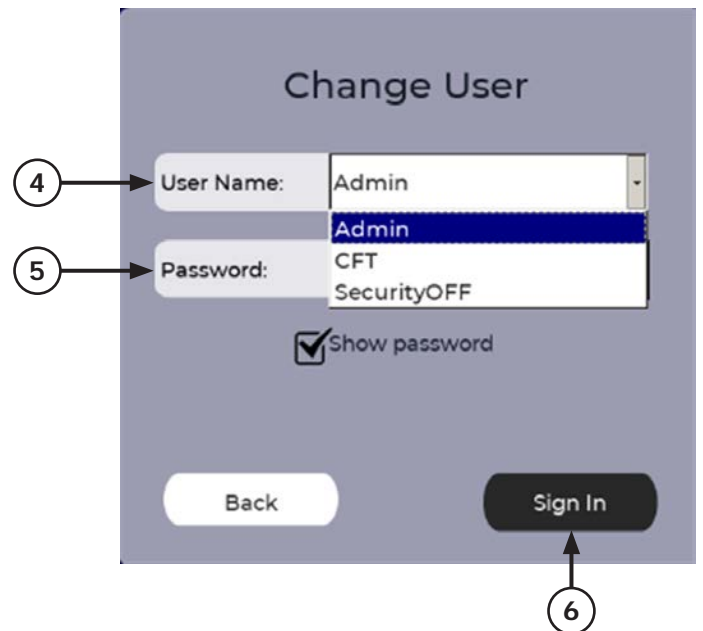
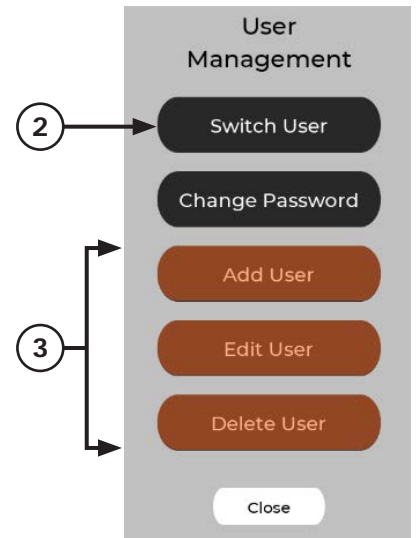
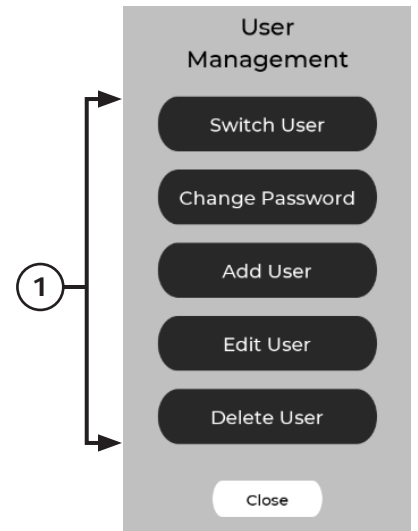

To Add or Edit a user, select the corresponding item from the menu and complete the sections (shown below).

After entering the User name and password, select the Group the User is assigned to. Groups are either Administrators or Sprayers.

Administrators have access to change all system settings, recipes, and material data. Administrators can also add, delete, and edit users.

Sprayers are able to access common operating settings and a reduced set of system, recipe and material settings.

Parameters and settings that are inaccessible to Sprayers are highlighted in orange on all screens, as shown below and on the following page.

1. User Name (press to open menu and select choice).
2. Group (select from menu).
3. Password is case sensitive, alphanumeric characters and normal special characters allowed (press to open menu and select choice).
4. Comment (optional free-form).
5. Mandatory First-Time Login Password Change (optional check box).
6. Inactivity Logout Time (enter optional timeout in minutes).
7. Sprayer-Inaccessible (examples are highlighted in orange).

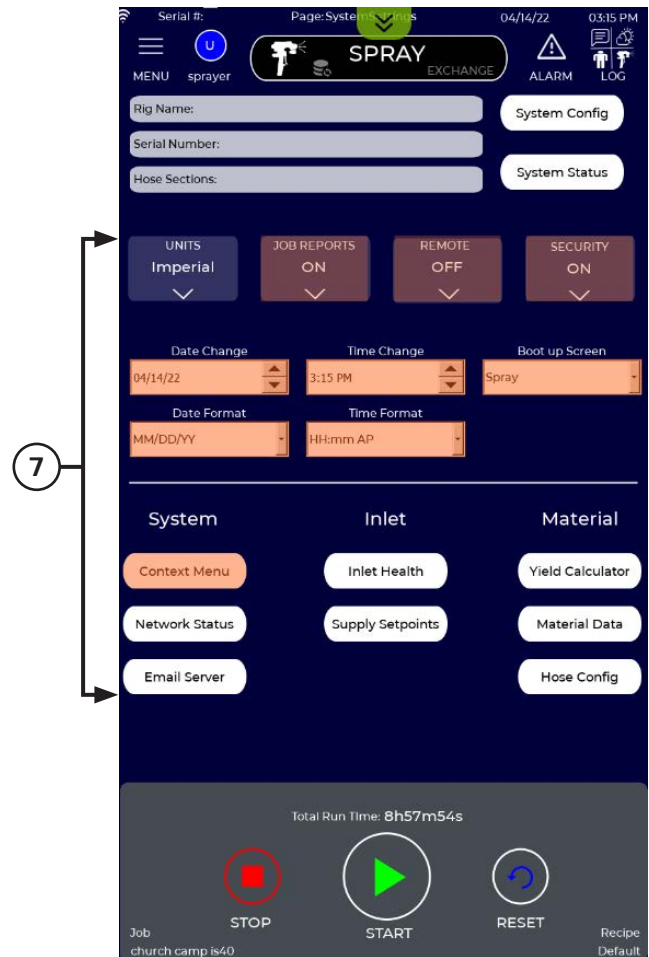
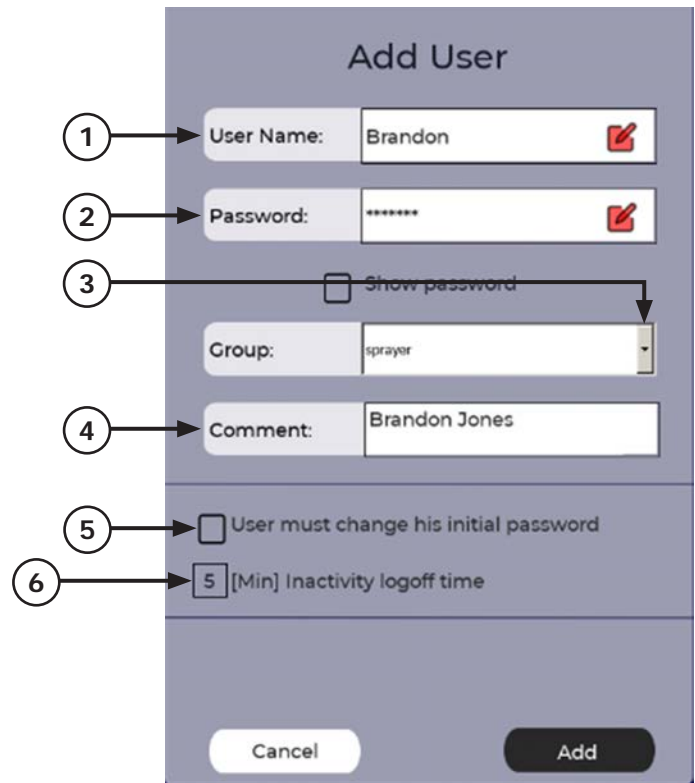

Serial #: [redacted] Page: Recipe [dropdown] 04/14/22 03:16 PM

MENU sprayer SPRAY EXCHANGE ALARM LOG

Parameter	Value	Unit
High Error	180	°F
High Warning		
Setpoint Max	150	
Setpoint	100	
Setpoint Min	80	
Low Warning		
Low Error		
Low Drum Temp Warning		
Low Drum Temp Error		
Recirc Max Temp	105	
PreHeat Offset	0	
Display Max	250	
Display Min	0	

Previous Next

RECIPE Default COPY NEW LOAD DELETE

Total Run Time: 8h57m54s

STOP START RESET

Job church camp is40 Recipe Default

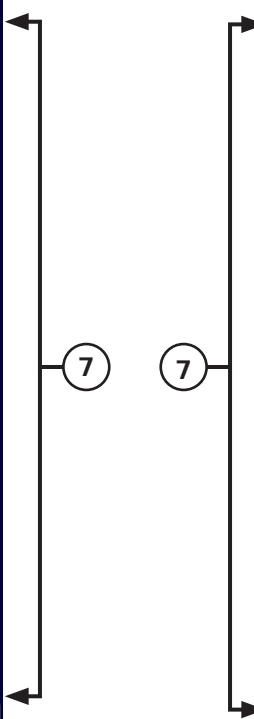

Serial #: [redacted] Page: Recipe [dropdown] 04/14/22 03:16 PM

MENU sprayer SPRAY EXCHANGE ALARM LOG

Parameter	Value	Unit
High Error	180	°F
High Warning		
Setpoint Max	150	
Setpoint	100	
Setpoint Min	80	
Low Warning		
Low Error		
Low Drum Temp Warning		
Low Drum Temp Error		
Recirc Max Temp	105	
PreHeat Offset	0	
Display Max	250	
Display Min	0	

Previous Next

RECIPE Default COPY NEW LOAD DELETE

Total Run Time: 8h57m54s

STOP START RESET

Job church camp is40 Recipe Default

Ratio

- License Key
- Ratio Control
- Parts A-ISO
- Parts B-RES
- Effective Ratio: 1.00 : 1
- Ratio Error

AVC °F

- Max Temp A-Side: 155
- Min Temp A-Side: 95
- Max Temp B-Side: 155
- Min Temp B-Side: 95

### RECIPE SCREENS—OVERVIEW

Recipes are collections of system parameter settings that can be created, saved, copied, edited, loaded, and deleted by the user.

Recipes allow users to quickly configure the system for different materials, job conditions, or user preferences.

Recipe capability is an optional feature and not required to operate the system.

The Recipe screen is accessed from the Main Menu and contains several sections as shown below and described in the following pages.

Recipe parameters are displayed and edited using five parameter tables.

1. Recipe Help
2. Parameters Tables (5)
3. Show Next Table (press to open).
4. Recipe Tables
5. Show Next Table (press to open).

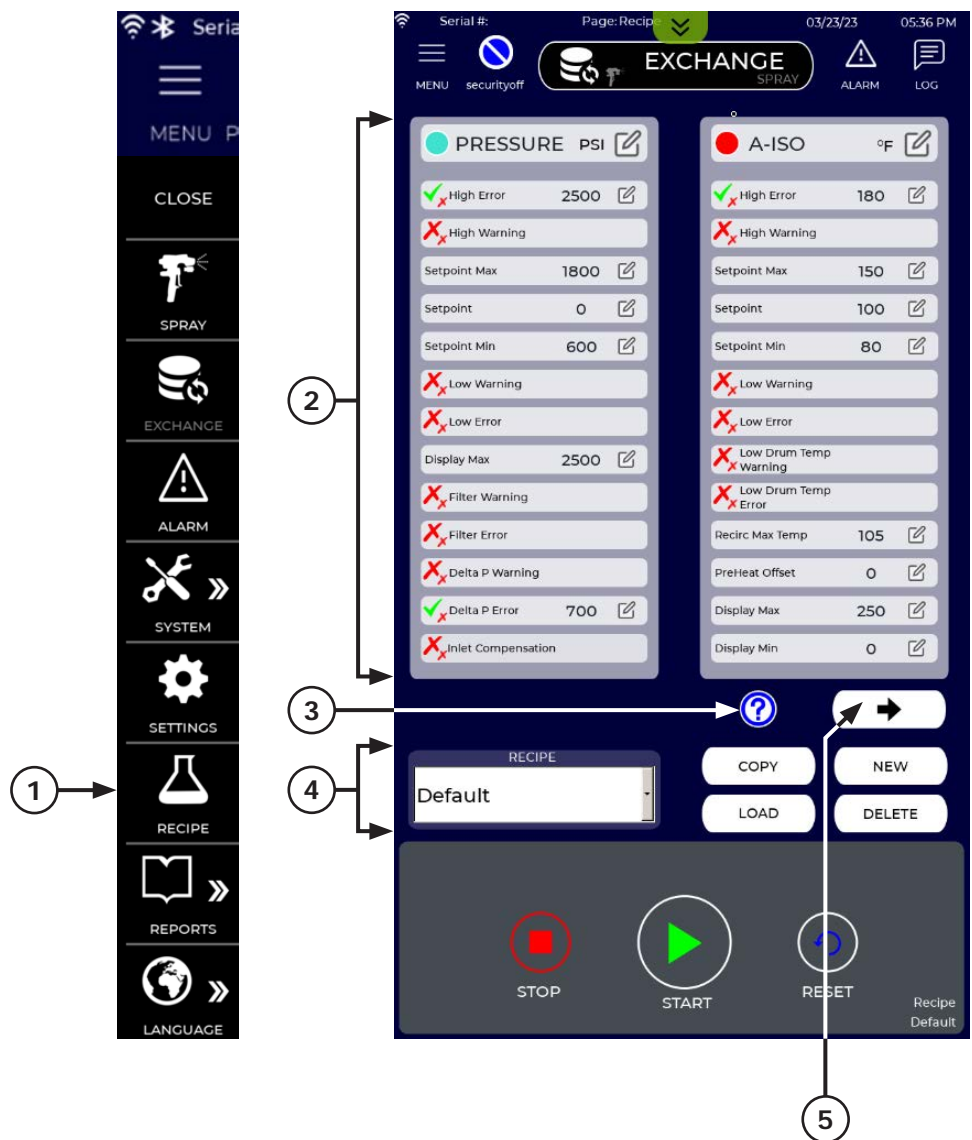



Each Recipe is defined by five tables. These tables are used to enable or disable parameters, set their respective values, and toggle parameter display markers on or off. While this may seem excessive, having full access to all parameters allows users to tailor their IS30 to their specific needs.

Two parameter tables are shown at any time on the Recipe screen. To move between tables press the arrow buttons on the Recipe screen shown in the following figure. The parameter tables make use of icons and labels to indicate parameter status. A legend of these icons is shown below. Parameters are categorized in Pressure, Temperature, Ratio, AVC™, and Miscellaneous tables.

Each table indicates which parameters are enabled, what their value is, and if they are graphically displayed on the Spray Screen (or elsewhere). Further descriptions of parameter tables are provided in the following pages.

1. Show Previous Parameter Table (press to open).
2. Show Next Parameter Table (press open menu).



PARAMETER TABLE LEGEND	
Enable	Enable or Disable Parameter
View	View or Hide Parameter Screen Icon
	Parameter is always on
	Parameter is on
	Parameter is off
	Select or change setting or value
	Parameter is enabled but not viewed
	Parameter is disabled and not viewed

**● PRESSURE** PSI

High Error 2250

High Warning

Setpoint Max 1800

Setpoint 0

Setpoint Min 600

Low Warning

Low Error

Display Max 2500

Filter Warning

Filter Error

Delta P Warning

Delta P Error 700

Inlet Compensation

**● A-ISO** °F

High Error 180

High Warning

Setpoint Max 150

Setpoint 100

Setpoint Min 80

Low Warning

Low Error

Low Drum Temp Warning

Low Drum Temp Error

Recirc Max Temp 105

PreHeat Offset 0

Display Max 250

Display Min 0

**● B-RES** °F

High Error 180

High Warning

Setpoint Max 150

Setpoint 100

Setpoint Min 80

Low Warning

Low Error

Low Drum Temp Warning

Low Drum Temp Error

Recirc Max Temp 105

PreHeat Offset 0

Display Max 250

Display Min 0

**● Ratio**

License Key

Ratio Control

Parts A-ISO

Parts B-RES

Effective Ratio 1.00 : 1

Ratio Error

---

**● AVC** °F

Max Temp A-Side 155

Min Temp A-Side 95

Max Temp B-Side 155

Min Temp B-Side 95

**● Misc....**

Pump A % Warning

Pump A % Error

Pump B % Warning

Pump B % Error

The Recipe Screen has one table for setting both A and B pressure parameters. Further description of each table parameter field is shown below. Factory default settings are shown in the figure.

1. Press to toggle parameter enable/view settings.
2. Displays error and stops system if this fluid pressure value is exceeded anywhere in the system Is always enabled. Max value is 2500 psi (172 bar).
3. Displays warning if this fluid pressure value is exceeded anywhere in the system.
4. Fluid pressure setpoint maximum. Always enabled and viewed.
5. Fluid pressure setpoint. Always enabled and viewed.
6. Fluid pressure setpoint minimum, Always enabled and viewed.
7. Displays warning if fluid pressure drops below this value at the end hose end sensor.
8. Displays error and stops the systems if fluid pressure drops below this value at the end hose end sensor
9. Maximum fluid pressure dial value (for dial scaling purposes only).
10. Displays error and stops system if inlet filter pressure drop exceeds value. Used to indicate plugged inlet filter.
11. Displays warning if inlet filter pressure drops.
12. Displays error and stops system if pressure difference at end of hose exceeds value.
13. Displays warning if pressure difference at end of hose exceeds value.
14. Enables Low Inlet Pressure Compensation (useful when transfer pumps cannot keep up with Proportioner).

See "SPRAY SCREEN-AUTOMATIC INLET COMPENSATION" for more information on Inlet Compensation.



The Recipe Screen has identical but separate tables for A and B Temperature parameters.

Further description of each Temperature table parameter field is shown below.

Factory default settings are shown in the figure.

1. Press to toggle parameter enable/view settings.
2. Displays error and stops system if fluid temperature exceeds value anywhere in the system. Parameter is always enabled.
3. Displays warning if fluid temperature exceeds value anywhere in the system.
4. Setpoint maximum. Always enabled and viewed.
5. Setpoint. Always enabled and viewed.
6. Setpoint minimum, Always enabled and viewed.
7. Displays warning if fluid temperature drops below value at the end hose sensor.
8. Displays error and stops system if fluid temperature drops below value at the end hose sensor.
9. Displays warning if incoming fluid temperature drops below value.
10. Displays error and stops system if incoming fluid temperature drops below value.
11. Maximum recirculation temperature in Exchange Mode
12. Preheat offset (positive or negative). May be required with low viscosity B-side materials. See "SPRAY SCREENS-OTHER FUNCTIONS".
13. Maximum temperature displayed on temperature gauge widget.
14. Minimum temperature displayed on temperature gauge widget.



The Recipe Screen also contains tables for Ratio, AVC™ (Automatic Viscosity Control) and Miscellaneous parameter settings. Further description of reach table and their respective parameter fields is shown below.

1. Press to toggle parameter enable/view settings.
2. Press to enable License Key.
3. Ratio control is always enabled and displayed on the Spray Screen.
4. Reserved for future use. User cannot change.
5. Reserved for future use. User cannot change.
6. Ratio setting is 1:1 and not adjustable by the user.
7. Warning is displayed if ratio error exceeds +/- value. Error is displayed and system shuts down if is ratio error exceeds +/- value.
8. Press to toggle parameter enable/view settings.
9. Maximum A AVC™ offset from setpoint.
10. Minimum A AVC™ offset from setpoint.
11. Maximum B AVC™ offset from setpoint.
10. Minimum B AVC™ offset from setpoint.
12. Convergence pressure difference between A and B when AVC™ is enabled.
13. Press to toggle parameter enable/view settings.
14. Warning is displayed and system shuts down if A pump efficiency drops below value.
15. Error is displayed if A pump efficiency drops below value.
16. Warning is displayed and system shuts down if B pump efficiency drops below value.
17. Error is displayed if B pump efficiency drops.

The screenshot displays three sections of the Recipe Screen:

- Ratio Section (1-7):**
  - 1: Ratio header (yellow circle icon)
  - 2: License Key (checked checkbox)
  - 3: Ratio Control (checked green checkbox)
  - 4: Parts A-ISO: 1.00
  - 5: Parts B-RES: 1.00
  - 6: Effective Ratio: 1.00 : 1
  - 7: Ratio Error: 5 %
- AVC Section (8-12):**
  - 8: AVC header (orange circle icon, °F)
  - 9: Max Temp A-Side: 155
  - 10: Min Temp A-Side: 95
  - 11: Max Temp B-Side: 155
  - 12: Min Temp B-Side: 95
- Misc... Section (13-17):**
  - 13: Misc... header (purple circle icon)
  - 14: Pump A % Warning (red X icon)
  - 15: Pump A % Error (red X icon)
  - 16: Pump B % Warning (red X icon)
  - 17: Pump B % Error (red X icon)

## RECIPE SCREENS—RECIPE MANAGEMENT

**Load a recipe:** The current Recipe selection is shown at the bottom right corner of each screen. If no Recipes have been defined the Proportioner selects and displays the Default Recipe. The Default Recipe can be modified, but never deleted.

Within the Recipe Screen, use the drop-down menu to select an existing Recipe.

**NOTE:** Selecting a Recipe does not activate it.

The parameters associated with the selected Recipe will now be shown in the Recipe tables and the selected Recipe name will be shown at the bottom of each screen. To activate the selected Recipe press the "LOAD" button, then press the Apply button.

1. Currently Selected Recipe
2. Recipe Menu (press to open menu and select choice).
3. Recipe Load (press "LOAD" to activate the selection for use).

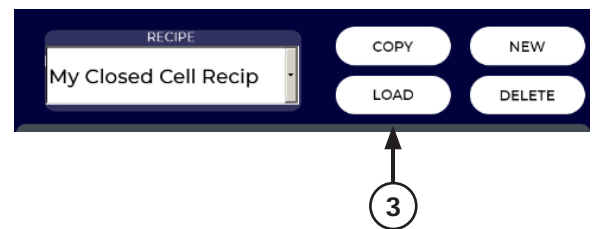
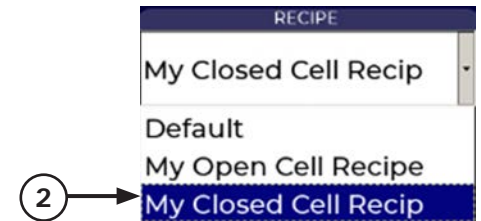
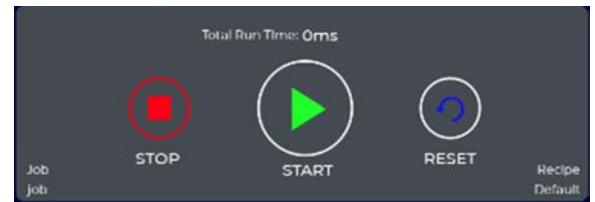



**Copy a recipe:** Press the "COPY" button, then select the Recipe to copy from, enter a new Recipe name, and press the Apply button.

The new Recipe will be displayed in the Recipe selection window. The Recipe tables can be edited as needed (per next pages) and the new Recipe activated by pressing the "LOAD" button.

1. Currently Selected Recipe
2. Recipe Menu (press to open menu and select choice).
3. Recipe Copy (press "COPY" to duplicate the selection).
4. Apply Button (press to save the duplicated selection).
5. Recipe Load (press "LOAD" to activate the new selection for use).



1



2

3

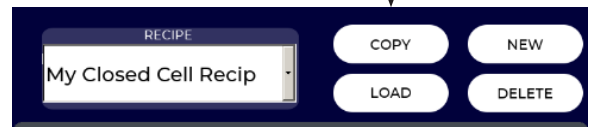

4

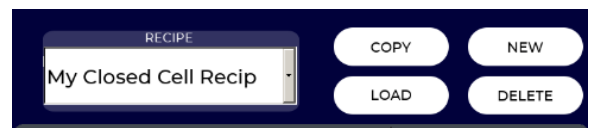

5



**Make a new recipe:** The new Recipe will be displayed in the Recipe selection window. The Recipe tables can be edited as needed (per next pages) and the new Recipe activated by pressing the "LOAD" button.

Use the "NEW" button to create a new Recipe. Enter the new Recipe name and press Apply. The new Recipe will be displayed in the Recipe selection window. The Recipe tables can be edited as needed (per next pages) and the new Recipe activated by pressing the "LOAD" button.

1. Currently Selected Recipe
2. Recipe Menu (press to open menu and select choice).
3. Recipe New (press "NEW" to make a new selection).
4. Apply Button (press to save the new selection).
5. Recipe Load (press "LOAD" to activate the new selection for use).



1

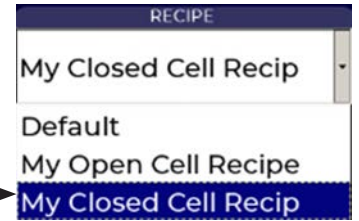

2

3



4

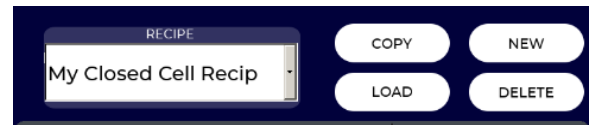

5

**Delete a recipe:** To delete the Recipe, first select it then press the "DELETE" button and then confirm the action by pressing the Apply button.

1. Currently Selected Recipe
2. Recipe Menu (press to open menu and select the recipe to be deleted).
3. Recipe Delete (press Delete the selected recipe).
4. Apply Button (press to confirm deletion).

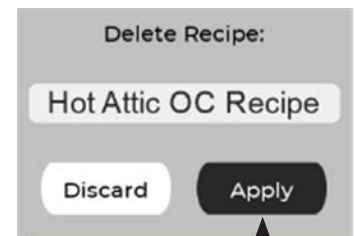
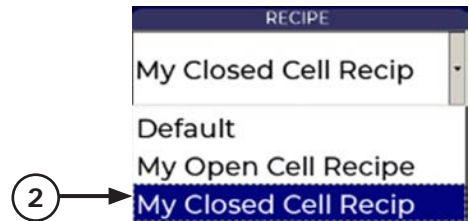
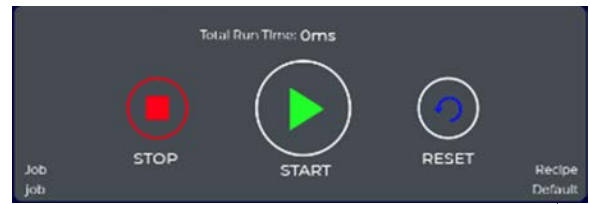

### RECIPE SCREENS—EDITING

Parameters in the Recipe Tables can be enabled or disabled, viewed or hidden, and values changed using icons and popup keyboards. Parameter status is indicated by icons as shown in the following legend.

To enable, disable, view, or hide parameters, press anywhere in the header section of the Parameter Table. Press the notepad icon to edit values of enabled parameters.

Pressing the header of a table opens the parameter control window. This allows the user to enable or disable and view or hide parameters.

The examples show the enabling the Low Error parameter and making it viewable on the Spray Screen.

Pressing the header of the Pressure Parameter table opens the control window. Pressing the Enable column in the Low Error row toggles the parameter on/off. Pressing the View column in the same row toggles parameter viewing on/off.

The Recipe Pressure table now shows the Low Pressure Error parameter as being both enabled and viewable. To assign a value for the Low Pressure Error parameter press the notepad icon and enter the desired value (in this case 500 psi).

After entering these changes, the Pressure Parameter Table for the selected Recipe will show the new value of 500 psi. To activate this change, the press the "LOAD" button.

1. Pressure (press to change, enable, or view settings).
2. Press to change value.
3. Press to toggle setting.
4. Press to save and exit.
5. Low Pressure Error
6. Pressure Value
7. Press "LOAD" to activate changes to Recipe.

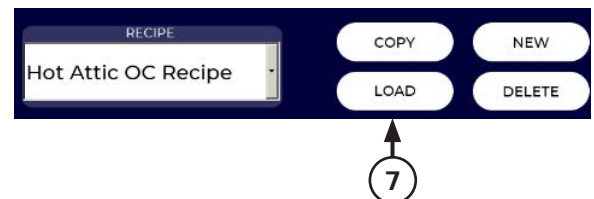
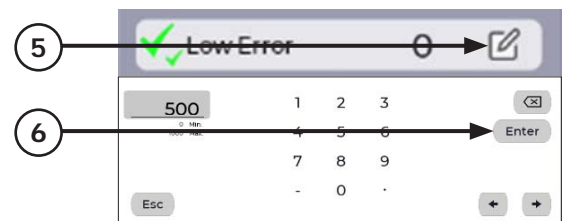
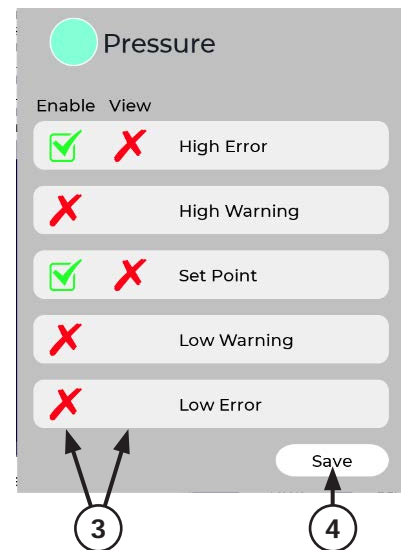
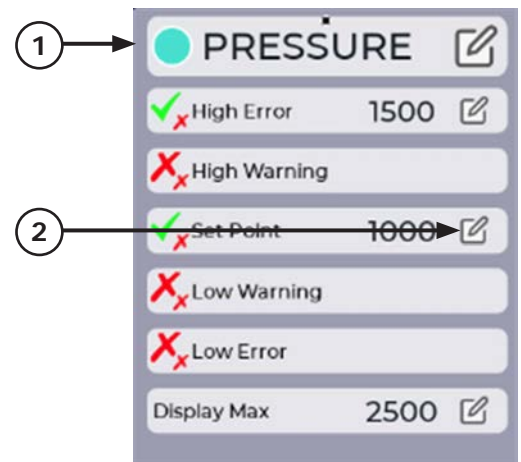

PARAMETER TABLE LEGEND	
Enable	Enable or Disable Parameter
View	View or Hide Parameter Screen Icon
	Parameter is always on
	Parameter is on
	Parameter is off
	Select or change setting or value
	Parameter is enabled but not viewed
	Parameter is disabled and not viewed

The following figure shows the pressure gauge in its most basic form as displayed on the Spray Screen.

High and low alarm parameters are enabled in this example but are not indicated on the gauge. The current Recipe table is shown below.

To enable viewing the high and low pressure alarm limits on the pressure gauge (both warning and error indicators). The user would toggle their respective view settings to on (green checkmark ✓) as shown below.

After pressing the "LOAD" button (to activate the Recipe changes) the alarm limit indicators are now shown as red (error) and yellow (warning) symbols on the pressure gauge.

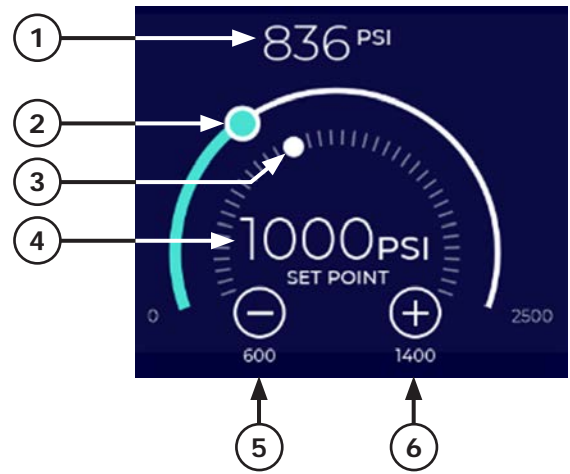

1. Actual Value (always shown).
2. Actual Value Marker (always shown).
3. Setpoint Marker (always shown).
4. Setpoint Value (always shown).
5. Minimum Setpoints (always shown).
6. Maximum Setpoints (always shown).
7. High/Low Alarm Parameters (example).
8. High/Low Alarm Limits (example).
9. High Pressure Warning Symbol
10. Low Pressure Warning Symbol
11. Low Pressure Error Symbol
12. High Pressure Error Symbol

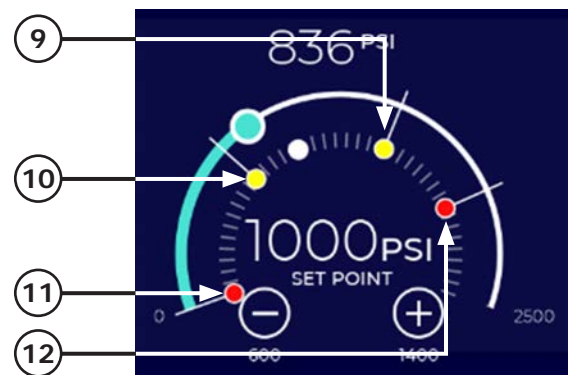
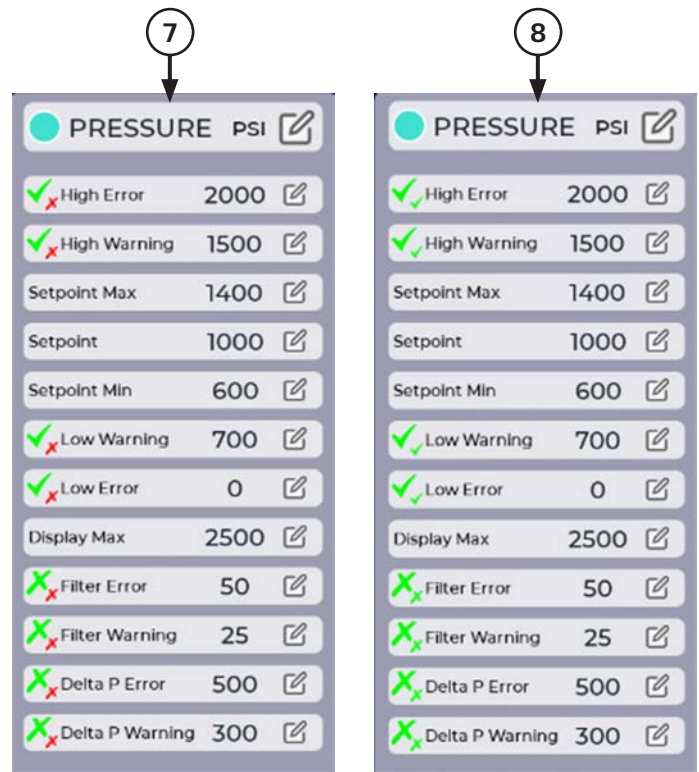

## REPORTS—OVERVIEW

The IS30 Proportioner has extensive reporting capabilities. These capabilities are divided into two areas: Job Reports and Audit Reports.

Job Reporting capabilities can be turned on or off in the Settings Screen (see "SETTINGS SCREENS"). The factory default setting for Job Reports is OFF.

Job Reports are described in "JOB REPORTS-OVERVIEW".

Audit Reports are always enabled, even when Job Reporting is disabled.

Audit Reports contain a record of user interactions with the IS30 screens, system alarms, and any Log Notes entered by the user.

Reports are accessed from the Main Menu. Select Reports and the specific Report Screen of interest.

The figure below shows the Job Reports Screen is grayed out. This indicates that Job Reporting is not currently enabled.

1. Report Screens (press to access and select).
2. Report (press to select desired report).

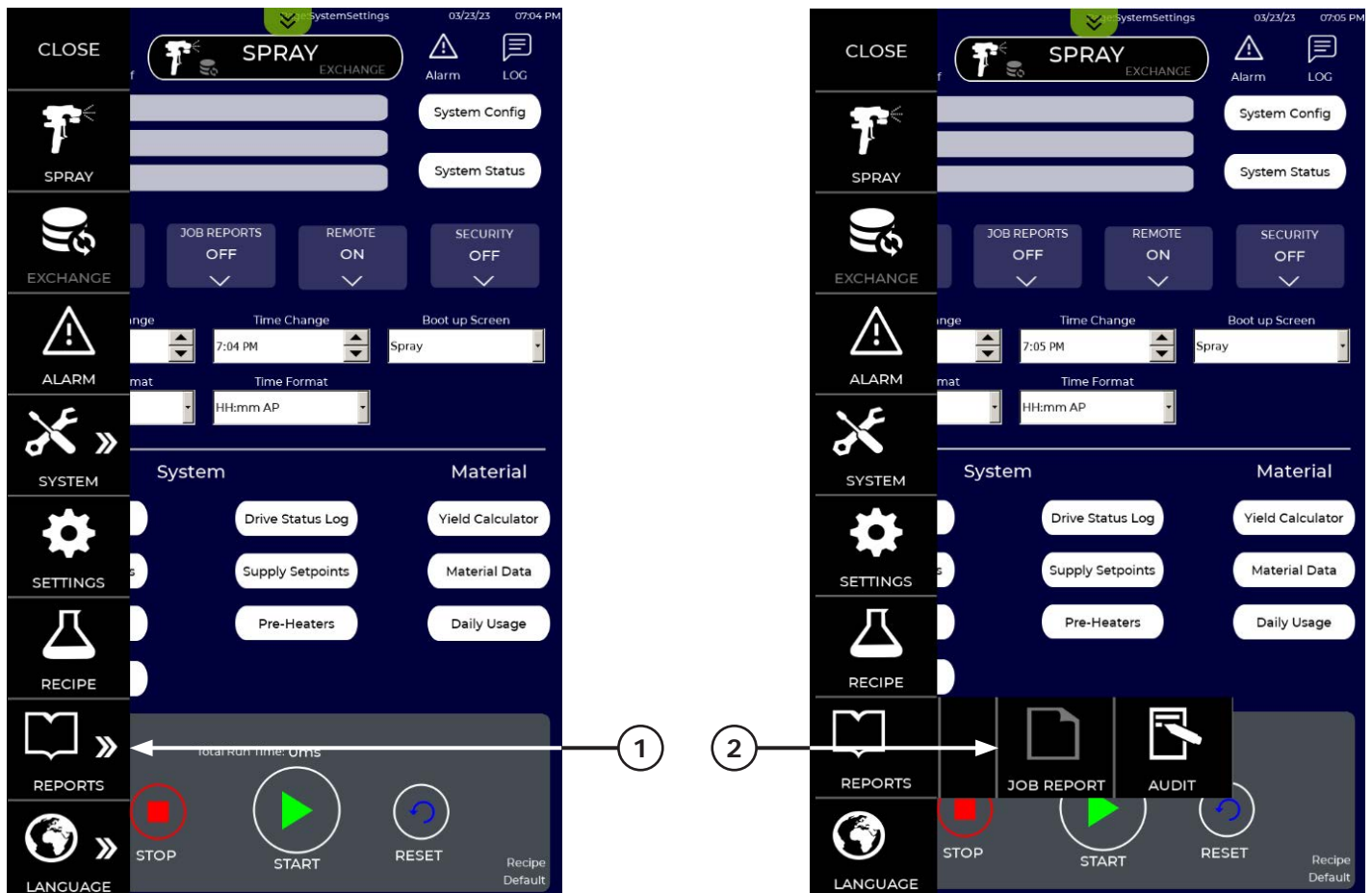

**REPORTS–AUDIT REPORT**

The Audit Report screen shows a time-stamped event table containing user interactions with the IS30 screens, system alarms, and any notes entered by the user.

Events are shown in descending time (most recent at the top).

The table can be navigated using the slider at the right of the table or by pressing the Forward and Backward buttons below the table.

The Proportioner retains up to 63,999 events before deleting the oldest events.

When Job Reporting is turned on the Audit table is included in the Job Report.

1. Refresh (press to update Audit table).
2. Duration (press to select lookback duration).
3. Slider (moves forward or backward in time).
4. Recorded ID (sequentially numbered events as they occur).
5. Timestamp (events are time-stamped).
6. User Name (active user logged with the event).
7. Operation (event type).
8. Information (of event).
9. Scrolling (swipe anywhere to move the table forward or backward in time).
10. Previous Events (press to see earlier entries).
11. Later Events (press to see later entries).

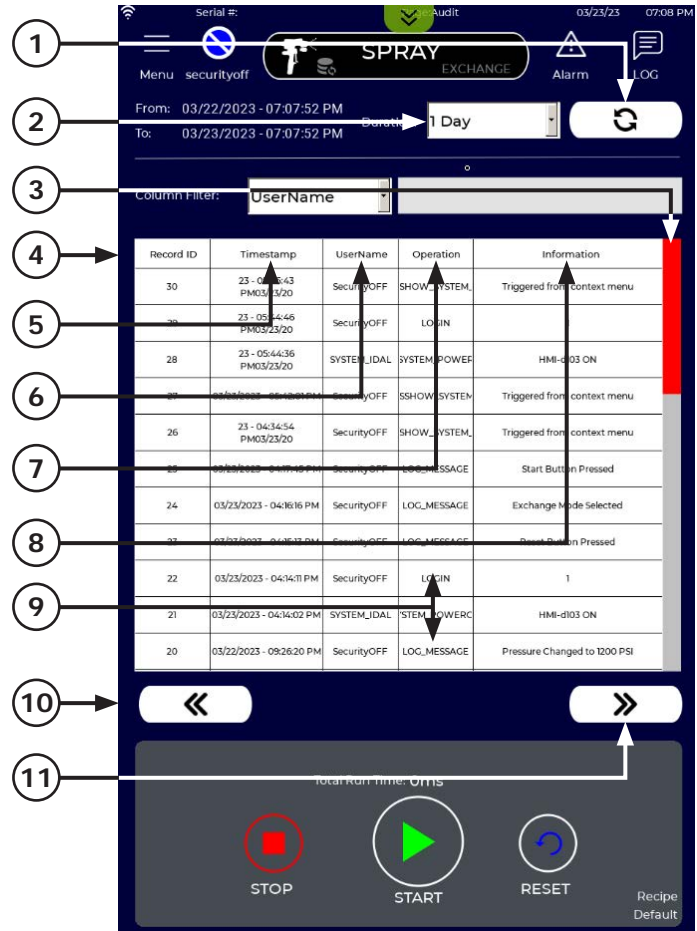



The Audit table can be very large, making it difficult to search for specific events of interest.

To make searching easier, the following functions are provided on the Audit Report screen.

**Select Duration**

The user can select a “look-back” duration using the Duration drop down menu. After selecting a different duration, press the Refresh button to update the Audit table to shown events that occurred only within the specified time frame.

**Filter Audit Events**

Audit events can be filtered using the Column Filter section of the Audit screen.

To use this feature, select the column to be filtered using the drop-down menu, then enter a filter value in the adjacent window.

Press the Refresh button and only those entries that match the Filter parameters will be shown in the table.

In the following example, we will find any pump related events in the Audit table that have occurred in the last 24 hours.

First, select “1 Day” from the Duration drop-down window.

Then select the Information column using the Column Filter drop-down window.

Press the target window to open the keypad. Type in “pump” (without quotation marks) and press the Enter key.

Only those Audit events showing the word “pump” in the Information column will now be shown.

Delete the Filter target word to clear the filter and show all entries.

1. Duration (press to select lookback duration).
2. Refresh (press to update Audit table).
3. Duration (press to select lookback duration).
4. Column Filter (event audit drop-down menu).
5. Target (press to open keyboard).
6. Type Window (enter "pump").
7. Audit Events (shows all events of "pump" operation).
8. Delete Filter Target (shows all entries).

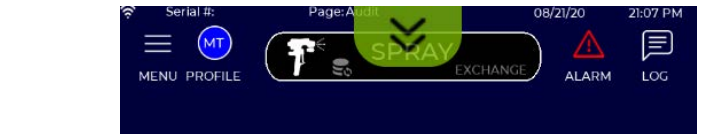

Record ID	Timestamp	UserName	Operation	Information
411	08/21/20 - 17:47:21	admin	LOG_MESSAGE	Alarm - Insufficient Drum Pump Pressure A
409	08/21/20 - 17:47:21	admin	LOG_MESSAGE	Stop Button Pressed
408	08/21/20 - 17:19:46	admin	LOG_MESSAGE	Stop Button Pressed
407	08/21/20 - 17:19:44	admin	LOG_MESSAGE	Start Button Pressed

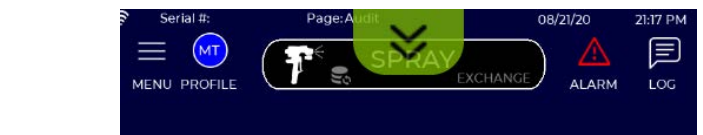

Record ID	Timestamp	UserName	Operation	Information
411	08/21/20 - 20:55:46	system admin		
410	08/21/20 - 20:55:32	system admin		
409	08/21/20 - 17:47:21	admin		
408	08/21/20 - 17:19:46	admin		
407	08/21/20 - 17:19:44	admin		
406	08/21/20 - 17:19:42	admin		
405	08/21/20 - 16:53:46	admin		
404	08/21/20 - 16:53:41	SYSTEM_IDIAL		
403	08/21/20 - 14:39:58	admin		
402	08/21/20 - 14:19:15	admin		
401	08/21/20 - 14:19:13	admin		
400	08/21/20 - 14:19:12	admin		
399	08/21/20 - 14:19:10	admin		
398	08/21/20 - 14:18:00	admin		
397	08/21/20 - 14:17:04	admin	ELEMENT_CHA	SystemRecipe:3,1500,000000

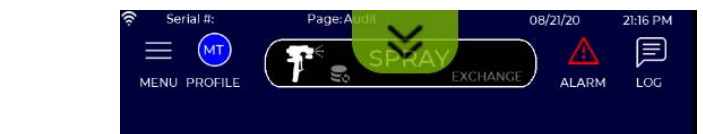

Record ID	Timestamp	UserName	Operation	Information
411	08/21/20 - 20:55:46	system admin	LOG_MESSAGE	ure BAlarm - Insufficient Drum Pump Pressure
410	08/21/20 - 20:55:32	system admin	LOG_MESSAGE	Pump Pressure AAlarm - Insufficient Drum

REPORTS—JOB NOTES

The IS30 allows users to enter and save notes in the Audit table.

These notes can be used to record information that may be of interest in the Audit Report or the Job Report.

A "LOG" icon is shown in the upper right corner of every screen. Users can open and enter job notes anytime the Proportioner is powered on.

To create a note. Press the "LOG" icon in the upper right corner of any screen.

A window will open to record the note. Press anywhere in the text window to activate the on-screen keyboard.

Enter the note using the on-screen keyboard. In this example the user wishes to record when a drum was changed, so enters "Changed B-side material" then presses the Enter key.

After entering the note text, press the "LOG" button to enter it into the Audit table. This will also time-stamp the note.

The note will appear in Audit Table as a "LOG-MESSAGE" operation.

1. LOG Icon (press to open note).
2. Job Notes (text entry box).
3. Keyboard Entry (note entered).
4. Enter (press to enter).
5. LOG (enters note into Audit Table).
6. Audit Table (user-entered note).

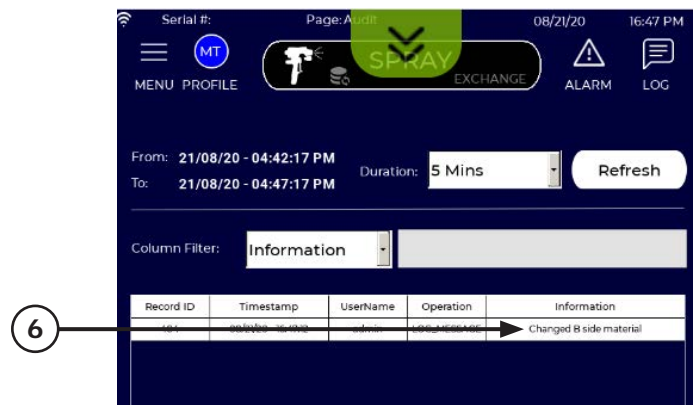
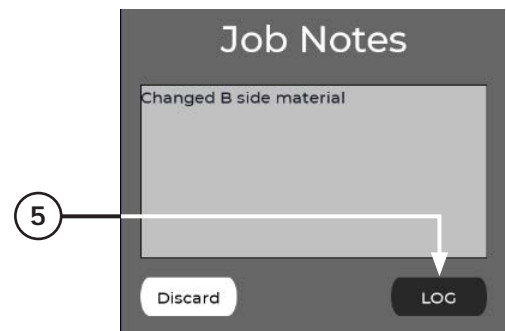
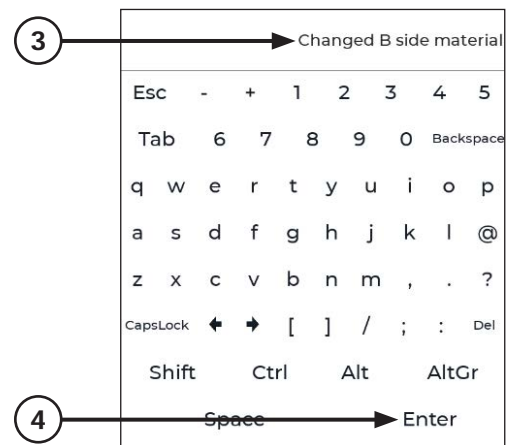
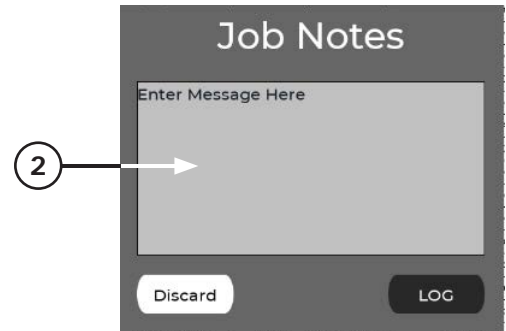

### JOB REPORTS—OVERVIEW

The IS30 has built-in Job reporting capabilities that provides users, contractors, and/or owners the ability to create, save, append and distribute comprehensive Job Reports that include:

- Job Information
- Job Conditions
- System Settings and Performance (including Ratio)
- Material Supply and Usage
- Yield Calculations

Reports are stored on the Proportioner and can be viewed locally, exported to USB, or emailed to any recipient. When exported, users can include additional detailed data files (in CSV format) containing machine performance data, alarms, and audit tables.

**Note:** If power is lost to the Proportioner and Job Reporting is "ON", any currently active Job will be lost. If a user needs to cycle power to the system, first "STOP" the proportioner and select "SAVE" or "NO" to avoid losing the Job information.

Job Reporting is toggled "ON" or "OFF" in the System Setting screen (see SETTINGS SCREENS-CONFIGURATION SETTINGS). Job Reporting is "OFF" as shipped from the factory. If Job Reports are "ON" a dialog window (as shown) will be displayed at system startup or after any Job is stopped. The user cannot proceed until they either select an existing Job from the pull-down menu, select Last Job, or create a New Job.

To create a new Job Report, press the "NEW" button. An input window will open to enter Job Information. Only the Job Name is a mandatory field.

Press the desired field to enter information, or press the "SCAN" button to use the optional QR code reader and capabilities of the Proportioner (for instructions on how to set this up contact your authorized IntelliSpray Distributor).

**Note:** The report can be presented with either Imperial or Metric values.

1. Job Reporting: Job Reporting can be toggled "ON" or "OFF" (factory default).
2. Last Job (press to accept).
3. Job Name (press to open menu).
4. New (press to create a new job)
5. Job Name (press to enter new job name).
6. Scan (press to scan QR code).

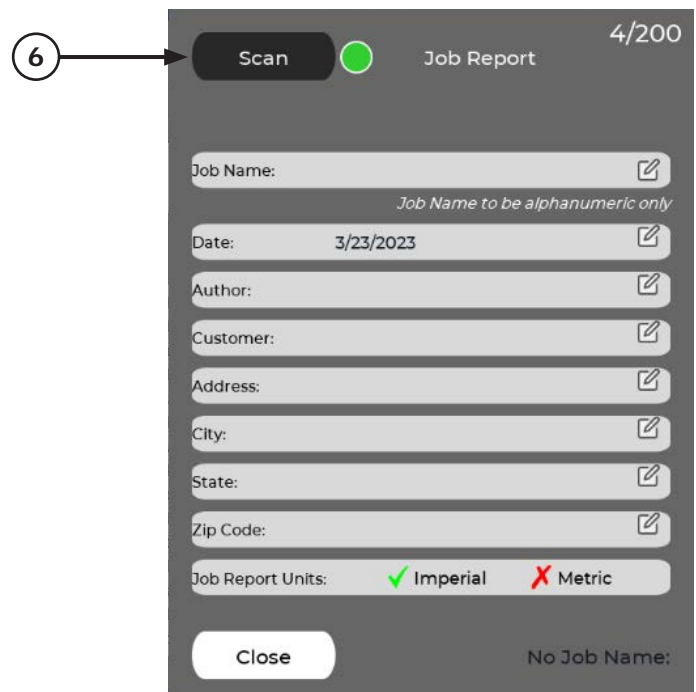
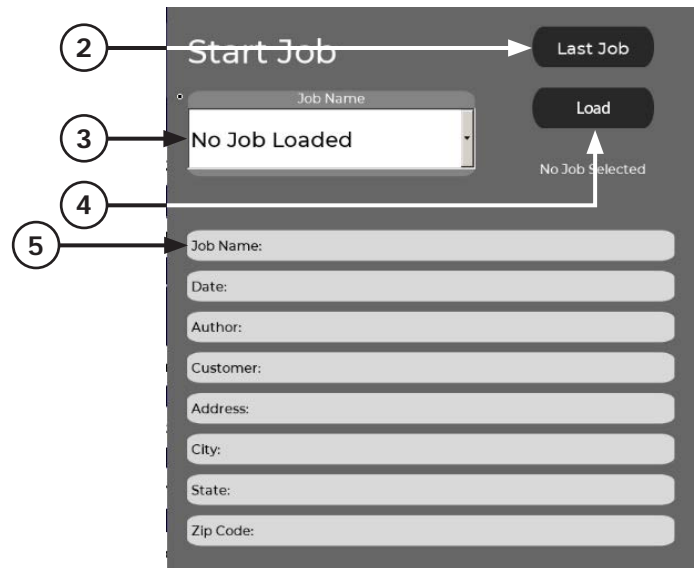

To enter Job Information press the notepad icon and enter information using the on-screen keypad. After the desired information is entered, press the "APPLY" button.

Finally, press the "LOAD" button to start the new Job.

The IntelliSpray Proportioner continuously saves all system data and dynamically creates the Job Report for the active (loaded) Job. The active Job is always shown in the lower right corner of the screens.

When Job Reports are "OFF", the Job Note icon is displayed in the upper right corner of the screens (as shown in the figure below).

See "REPORT-JOB NOTES" for instructions on Job Notes.

Allows logging of Job Notes when Job Reporting is "OFF". When Job Reports are "ON", the Job Notes icon changes to provide more options to enter Job related information.

Pressing this icon opens a menu of options as shown below.

1. Job Information (press to open note).
2. Apply (press to accept).
3. Load (press to load job).
4. Active Job
5. Job Note Icon
6. Job Logging Menu
7. Log Menu (press each to open).

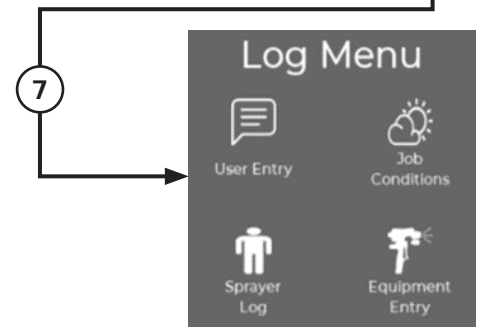
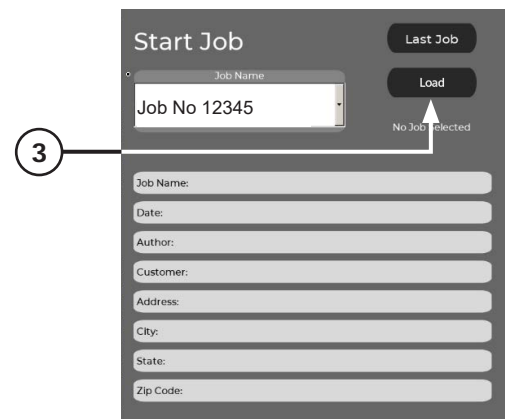
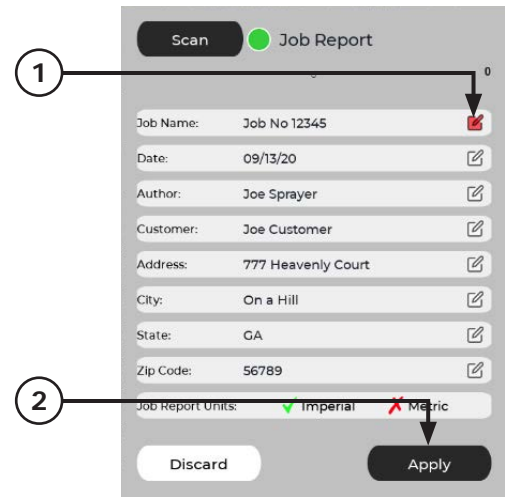

The Job Logging menu consists of 4 selections that allow a user to enter information about the Job. This information is not mandatory for a Job Report. Press on the specific menu item to open a data entry window.

**User Entry:** Job Notes that will be included in the Job Report.

**Job Conditions:** Environmental and substrate conditions, which will be included in the Job Report.

**Sprayer Log:** Start and stop time for any Sprayer (in the event there are different Sprayers on the same Job).

**Equipment Entry:** Used to record information about the Spray gun used.

**User Entry:** This function allows a user to enter any information they want to associate with the job. The message is time stamped and entered in the Audit Trail that is provided with the job report. When selected, a dialogue window appears that allows the user to enter free-form text information with the on-screen keypad. Examples of notes the user may want to enter include job conditions, gun setup, breakdown or service issues, recommendation for their boss, lunch break times, etc. Any information a user wants to connect to the job report can be entered. When they press the "LOG" button, the message is time stamped and added to the Audit Trail. They can also press "Discard" if they want to cancel the entry.

**Sprayer Log:** This function allows entry of sprayers and their start/stop times associated with the Job. This information will be displayed in the Job Report. A single job can have up to 15 different sprayer entries. Sprayer names are stored and can be accessed in the pull-down menu, or a new sprayer can be entered on this screen. Once entered, the system will add that sprayer name to the pull-down menu). The sprayer can enter this information any time to the active job (e.g. even at the end of the day).

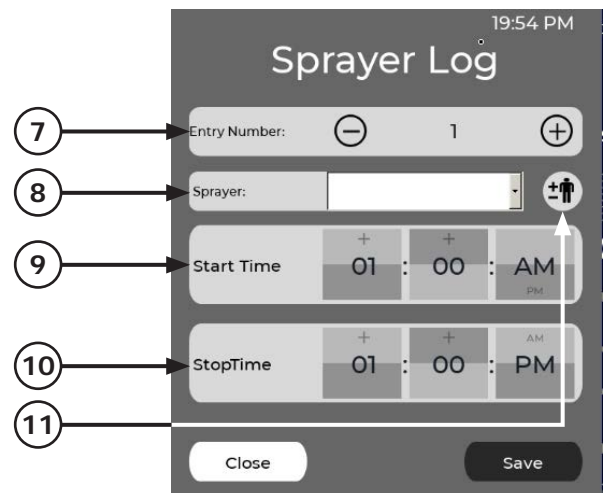
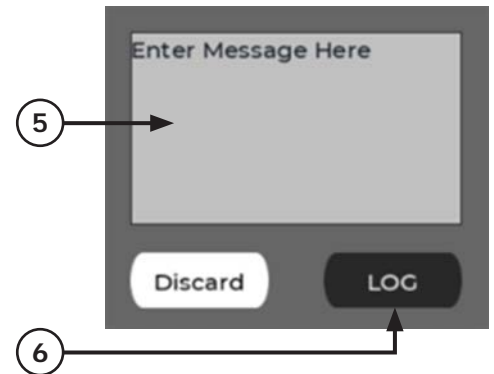

1. User Entry
2. Job Conditions
3. Sprayer Log
4. Equipment Entry
5. User Entry
6. Sprayer Log
7. Entry Number
8. Sprayer
9. Start Times
10. Stop Times
11. New Sprayer Name



**JOB REPORTS—LOG ENTRIES**

**Job Conditions:** This feature allows the user to enter up to 20 different environmental and substrate measurements for a given Job Report.

The time the conditions are measured can be automatically time stamped or the time can be manually entered by the user.

The user selects when the conditions were measured by selecting a value from the Tigger pull-down menu. Substrate types are selected from a pull-down menu.

1. Entry Number (press to enter).
2. Time (press to open note).
3. When (press to select occurrence time).
3. Relative Humidity (press to open note).
4. Substrate Type (press to open menu).
5. Substrate Temp (press to open menu).
6. Substrate Moisture (press to open note).
7. Save (press to save settings).
8. Select When ("When" pull-down menu).
9. Select Substrate ("Substrate Type" pull-down menu).

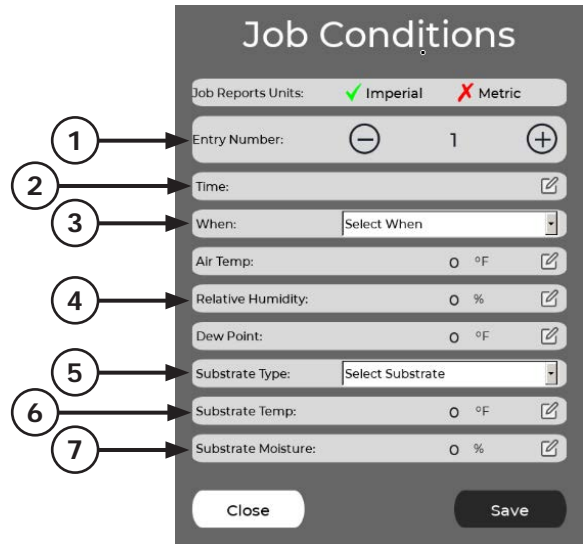

**Equipment Entry:** The Equipment log allows users to enter up to 10 different spray gun types and configurations used on a Job.

Users can select the time the spray gun was put into service on the job or enter it manually. Gun information is selected via pull-down.

10. Entry Number (press to enter).
11. Time (press to open).
12. Spray Gun (press to open menu).
13. Mix Chamber (press to open menu).
14. Mix Tip (press to open menu).
15. Select Spray Gun ("Spray Gun" pull-down menu).
16. Select Mix Chamber ("Mix Chamber" pull-down menu).
17. Select Mix Tip ("Mix Tip" pull-down menu).

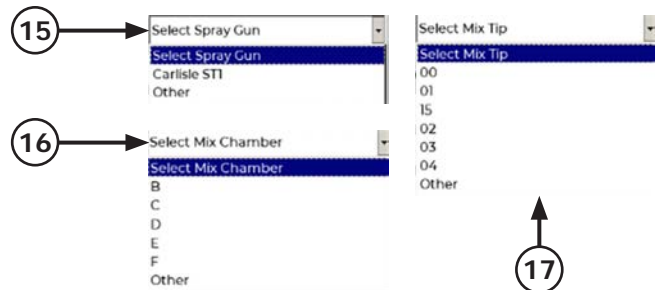
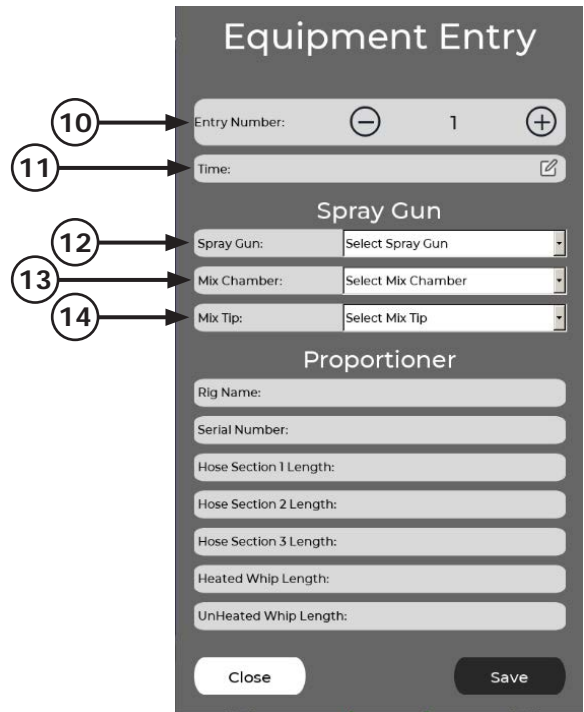



## JOB REPORTS—MATERIAL INFO

To include A and B material information on Job Reports, users can enter up to 7 items describing each drum of material used on the job.

Entering material information is optional for Job Reports but is highly recommended for traceability and confirmation of materials used.

Material information is entered by pressing the A or B drum icon on the Spray Screen. This opens a material input window for collecting information.

1. Press on A or B drum icon to open material input window.

When Job Reporting is "ON" the material information window displays additional fields for entering material data.

Material data can be entered through the Drum icon, or via the Material Library. Data is retained and stored in the Material Data library to make subsequent entries easier.

### When changing drums:

2. Scan (press to scan).
3. Drum Level (enter the fluid level using the keypad icon). Use a Carlisle drum dip stick or equivalent to accurately measure the fluid level before entering.
4. Drum Number (increment the drum number by pressing the + button).
5. Date/Time (time-stamp the entry by pressing on the keypad icon).
6. B-RES Material (use the pull down menu to select a material that has been previously defined). This will automatically populate the next three fields OR enter the information directly by selecting the keypad icon next to each field.
7. Manufactured Information (enter the Manufactured Date, Expiration Date, and Batch number for each drum of material).
8. Close (press to close)
9. Save (press to save settings).

The "SCAN" button can be used with some drums to auto-fill information fields. Contact your authorized IntelliSpray Distributor for more information.

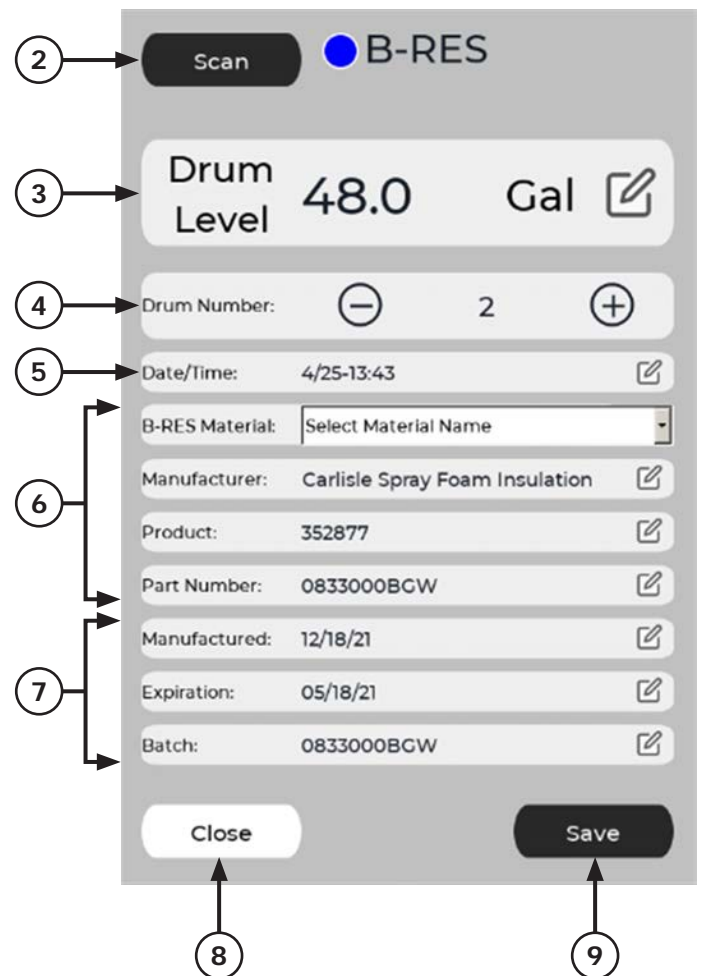
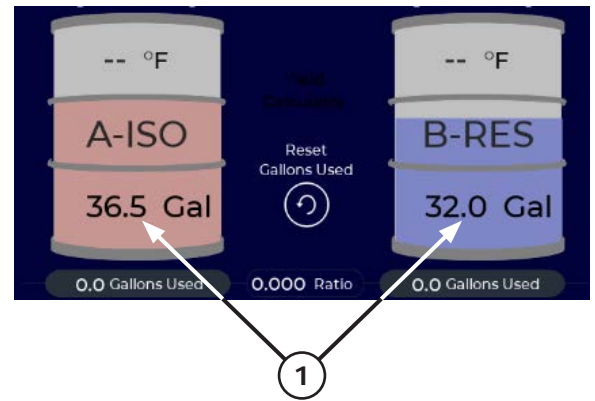

### JOB REPORTS—REPORT CONTENT

When Job Reporting is "ON" the unit is continuously updating the currently active Job Report, which can be viewed on-screen by selecting REPORTS > JOB REPORTS from the Main Menu.

The Job Report has a main summary page is followed by 8 additional pages containing detailed information about ambient conditions, materials, yield calculations, sprayers, and equipment used on the job.

1. Job Header (printed on every page)
2. Job Conditions Summary (job conditions summary including minimum, maximum, and average).
3. Application Summary (process parameters summary including minimum, maximum, and average).
4. Material Input Summary (material conditions summary including minimum, maximum, and average).
5. Material Usage Summary
6. System performance summary
7. Yield calculation summary (if performed by user)
8. Previous (to view earlier reports).
9. Home (to return to the home screen).
10. Next (to move to the next screen).
11. Report Management (includes USB export, email, and delete).

**Daily Job Log**

Job Name: Job No 12345      Start Date: 09/13/20  
 Customer: Joe Customer      End Date: 8-24-2020  
 Address: 777 Heavenly Court      Author: Joe Sprayer  
 City: On a Hill      State: GA      ZIP: 56789

**Job Summary**

# of Entries 0 / 20	Minimum	Maximum	Average
Air Temp	0	0	0.0
Relative Humidity	0	0	0.0
Dew Point	0	0	0.0
Substrate Temp	0	0	0.0
Substrate Moisture	0	0	0.0

Parameter	Set Point MIN	Set Point MAX	Average
A-ISO Temperature	0	0	0
B-RES Temperature	0	0	0
Pressure	0	0	0
Ratio = (A-ISO / B-RES)	1.00	1.00	0.00

Supply	Minimum	Maximum	Average
A-ISO Inlet Temp	0	0	0
B-RES Inlet Temp	0	0	0
A-ISO Inlet Pressure	0	0	0
B-RES Inlet Pressure	0	0	0

Material Amount	A-ISO	B-RES	Total
Spray	0.00	0.03	0.03
Exchange	0.00	0.00	0.00
Job Total	0.00	0.03	0.03

Machine On Time	0ms
Spray Time	0ms
% Trigger On Time	nan.0
Gallons Per Hour	inf.00

# of Entries 0 / 30	Minimum	Maximum	Average
Ratio (A-ISO/B-RES)	0.000	0.000	0.000
Bdft/Set	0.00	0.00	0.00
Bdft/Gallon	0.00	0.00	0.00
Calc In-Place Density (Lb/cuft)	0.00	0.00	0.00

Navigation: [Left Arrow] [Home Arrow] [Right Arrow] [USB EXPORT] [EMAIL] [DELETE]

Job Name: Job No 12345      [END JOB]

### JOB REPORTS—REPORT MANAGEMENT

Each page of the on-screen Job Report contains a section for Report Management. This section contains buttons for navigating, exporting, ending, creating, and deleting Job Reports.

Creates a new Job, or loads (continues) an existing Job.

Loading an existing Job allows the user to continue logging information from a prior incomplete Jobs.

To Load an existing Job, select it from the pull-down menu, then press Load.

The "END JOB" button is used at the end of Job.

If the user wishes to continue this job in the future they should press "NO".

Ending a Job prevent additional information to be added to that Job Report.

The system will also prompt the user when they hit the stop button.

If the user chooses to end a job the following dialogue box appears, which allows the user to email the Job Report and associated files.

See the next page for instructions on emailing or exporting Job Reports.

1. Previous (to view previous Job Report page).
2. Home (returns to page 1 of the Job Report).
3. Next (to view the next page of the Job Report).
4. Job Name
5. Report Management (includes end job, USB export, email, and delete).
6. Job Name (load a job from the menu).
7. New/Load (to create a new or load an existing job).
8. End of Job (ends job reporting).
9. End Job (to end job).
10. End Job and Email (to email job reports).

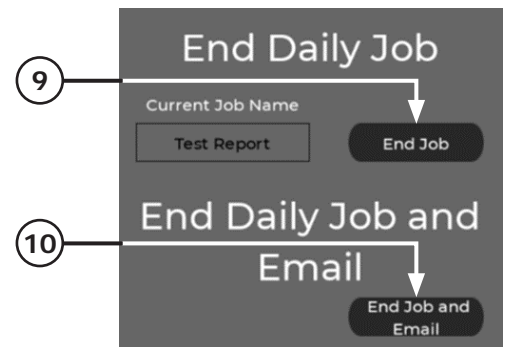
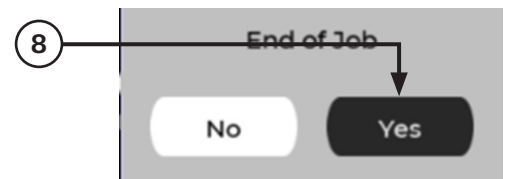
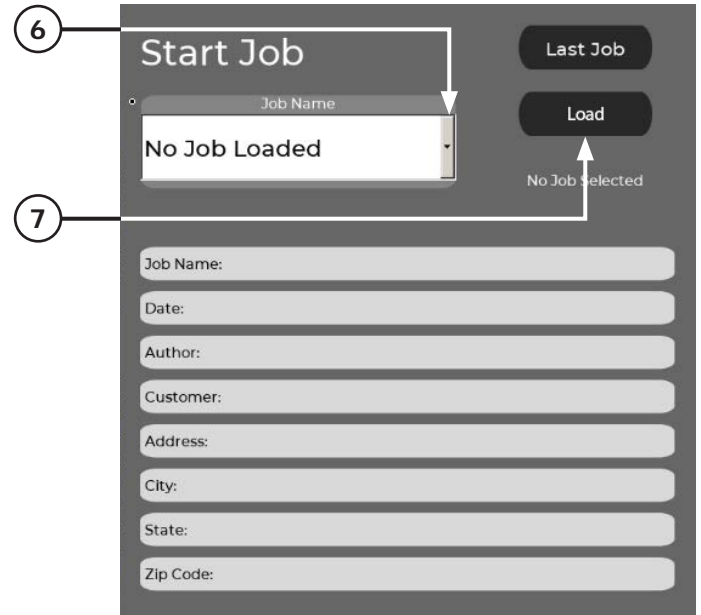
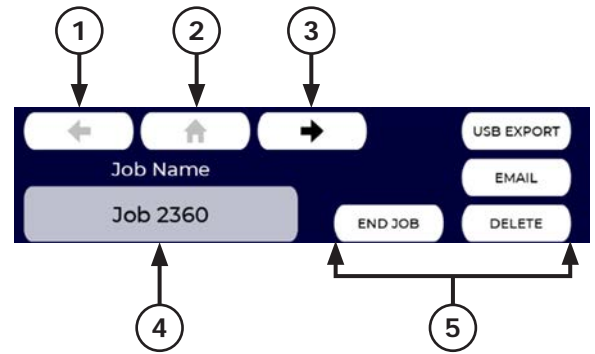

**DELETE:** Deletes a Job and information for that Job. When the Delete button is pressed, a window will open that allows the user to review and select the Job Report to delete. Since this is a non-recoverable action, a confirmation is required. This unit can store up to 200 Job Reports. Once this limit is reached it will delete the oldest Job Report automatically to create space for the next Job Report.

**EMAIL:** If the "EMAIL" button is pressed the following dialogue box appears. To email a job report, select the Job to email from the drop-down window, select the checkbox for Full Report or Simple Report and press the Attach Report button. Select the email recipient from the pull down menu or enter it by selecting the email icon. Add text to the email (optional) and press "Send".

To enter a new email recipient, select the email icon. Press "Add New Email Here" and use the onscreen keyboard to enter the address. Press "Add", then "Close". The new email recipient will now be retained for future use. Up to 20 email addresses can be stored.

**Note:** For email to work the Proportioner must be equipped with a cellular modem (standard in North America) and have an active SIM card with cellular data plan. Email settings must also be properly configured (see "SETTINGS SCREENS–SYSTEM INFORMATION").

**EXPORT PDF:** The "EXPORT PDF" function copies Job Reports to a USB memory stick inserted in the IntelliSpray's USB port on the side of the Control Module.

After pressing the "EXPORT PDF" button the following menu appears. Select the Job to export from the drop-down menu and press Attach. To copy all Job Reports to the USB device, press "Attach All".

1. Job Report (select to delete).
2. Delete Job (press to delete selected job).
3. Attach Report (press to attach selected report).
4. Job Reports (select from menu).
5. Email Call-Up (press to select from menu).
6. Email Recipient (select from menu).
7. Email Message Text Box
8. Send (press to send report).
9. Add New Email Address
10. Add (add email address).
11. Select Email To Delete (select from menu).
12. Close (press to close the window).
13. Attach (attach files to send to USB drive).
14. USB Drive (select the USB drive).
15. Attach All (press to attach all files to the USB drive).

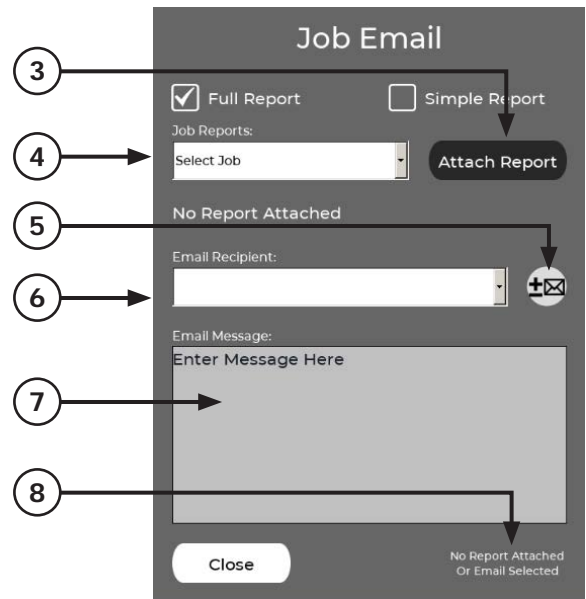

## LANGUAGES

IntelliSpray Proportioners can display text in any of the following languages:

- English (Factory Default)
- Spanish
- Chinese
- Greek
- German
- Polish
- Italian
- Dutch
- French
- Japanese

To change the setting, select the desired language from the drop down menu.

Press on the language to change the displayed text.

1. LANGUAGE (press to display available languages).
2. LANGUAGE ICONS (select the desired language icon from the menu).



**VARIABLE RATIO OPERATION  
(OPTIONAL FEATURE PN 347682)**

**ENABLE VARIABLE RATIO**

To enable variable ratio, complete the following steps:

1. Plug in the Variable Ratio dongle (not shown).

2. Navigate to the Recipe screen: Menu → Recipe (not shown).
3. Navigate from there to the column that is labeled "RATIO" and contains the arrow buttons.
4. License Key (click in the check box).
5. Variable Ratio will be enabled if the Variable Ratio key is detected.



**AUTOMATIC KEY DETECTION**

Automatic detection of the key:

Every 5 minutes the system scans if the key is detected.

Due to the system programming, if you use this method to initially activate the Variable Ratio key it can take as long as 7.5 minutes to be enabled, and depends on when the key was plugged into the port.



**ENABLE FIRST TIME**

The events that will occur once Variable Ratio is enabled for the first time:

1. The "License Key" check box on the Recipe screen will change from unchecked...
2. ... to checked.

3. The Ratio Control indicator on the Recipe screen will change from a red **X**...
4. ... to a green checkmark **✓**.
5. The Ratio Error will change from a blank state (disabled)...
6. ... to a populated state (enabled).



7. If the Ratio Control field is disabled, it can only be turned back on using the Ratio Control field.
8. To enable the Ratio Control, check the box next to "License Key", then press the License Key option to reactivate the license key.
9. A dialog box will open on the Spray screen. It will indicate if the Variable Ratio is on, and the A-ISO and B-RES drums interfaces.
10. If there is anything other than a 1:1 ratio, disable the ratio control (7) by unchecking the License Key box (5). The system will automatically be reset to show the 1:1 ratio.

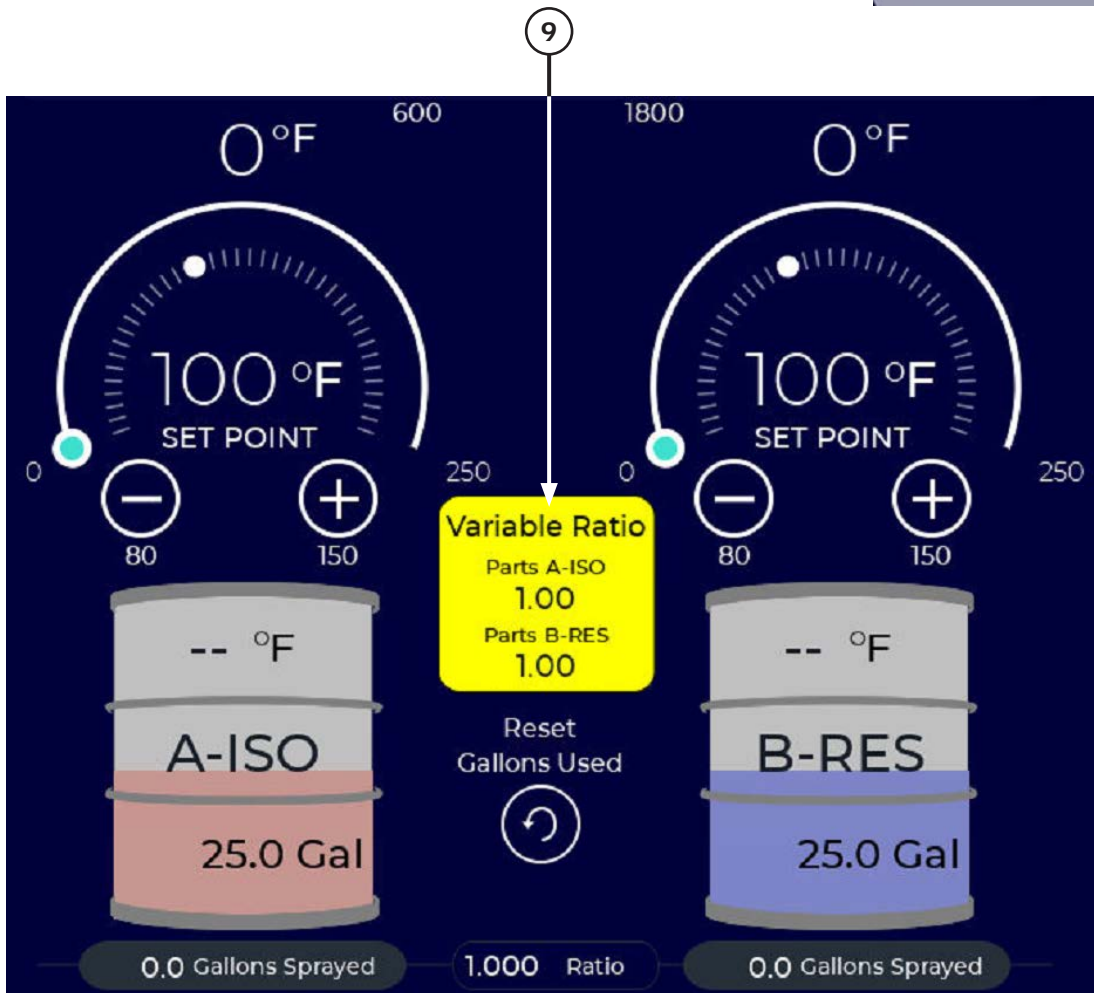
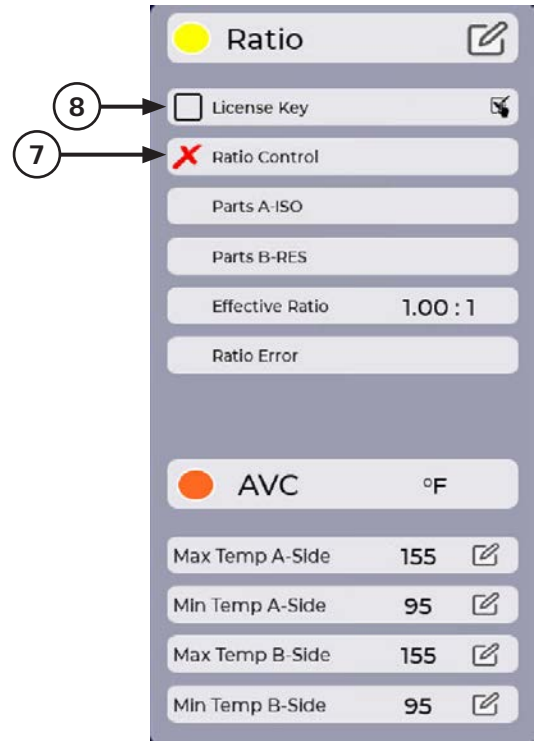

## SERVICING

The IS30 Fluid Modules are designed for easy service. Most components and assemblies are easily accessed from the front of the Fluid Module and can be replaced in minutes with minimum tools and fluid loss.

Normal service of the Fluid Modules consists of the following:

**Inlet Filter Service:** The inlet filters on the IS30 prevent solids from entering the Fluid Modules, hoses, and spray gun. The IS30 alerts users when the inlet filters require service, taking the guesswork out of filter maintenance. Pressure drop across each filter module can be seen in the I/O page. The following steps are taken when filter maintenance is required.

1. Press the Stop button on the IS30 screen.
2. Turn the power switch to the "OFF" (O) position to turn off the power.
3. Turn off the supply pump(s) to close the upstream supply valves.
4. Put a bucket under the filter cap to collect drips.
5. Close the inlet ball valve and filter isolation valve.
6. Use a 7/8" socket or box head wrench and loosen the filter cap 2 turns.
7. Let the pressurized fluid drip into the bucket.
8. Pull the filter assembly out of the filter manifold.
9. Slide the filter element off the filter body.
10. Clean the filter and filter body with a compatible solvent (e.g. Brake Cleaner, TSL, Dynasol, DPM, etc.).
11. Examine the O-ring for any tears, permanent set, or damage and replace if necessary.
12. Apply ST1 gun grease (or equivalent) to the O-ring for reassembly.
13. Reinstall the filter element, but replace if damaged.
14. After residual material has drained from the filter manifold, clean the internal threads with a compatible solvent.
15. Put a light coat of ST1 gun grease (or equivalent) on the internal manifold and filter body threads.
16. Insert the filter body and element into the filter manifold.
17. Torque the filter body to the manifold at 30 ft-lb.
18. Open the inlet ball valve and the filter isolation valve.
19. Open upstream supply valves and turn on the supply pumps.
20. Resume spray operation.

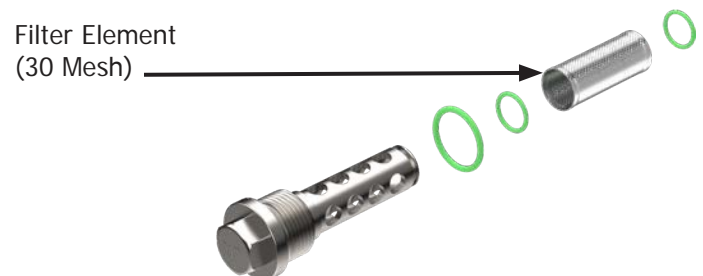
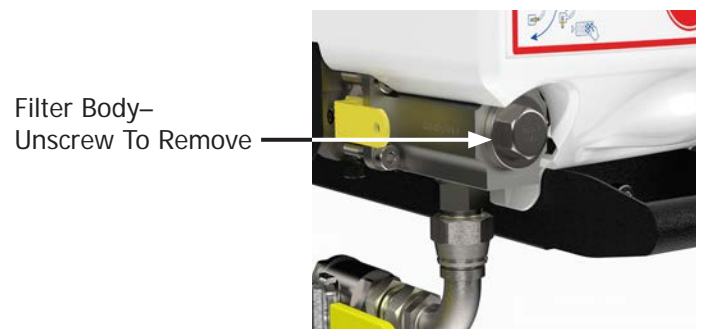
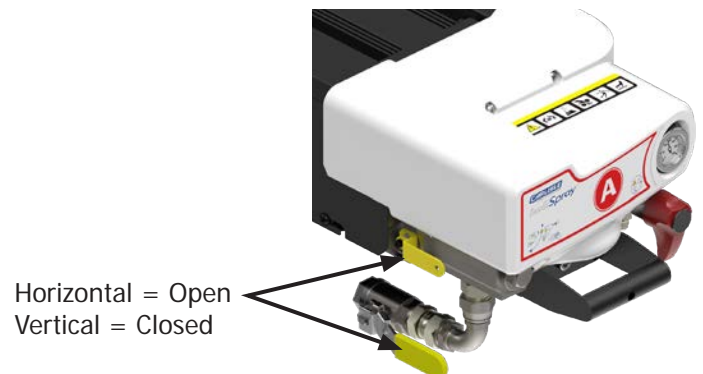

## QUICKHEAT™ HOSE CONNECTION

**Check Pump TSL Level:** The gear pumps in each Fluid Module include a chamber around the drive shafts that is filled with TSL (Throat Seal Liquid) at the factory.

This prevents atmospheric moisture from migrating into the shaft seals where it could react with Isocyanate in the A-side pump, causing abrasive crystalline material to form that may damage the shaft seal. The fluid also lubricates the shaft seals on both A and B pumps.

Since the TSL and pump shaft are not exposed to the environment (as in a piston pumps) loss of fluid is unlikely, However, regular checking of TSL level should be performed as follows:

1. Loosen the captive fluid module retention screw, pull the retention pin, and slide the module into the second service position (second detent).
2. Loosen the two module cover retention screws and slide the cover off the fluid module.
3. Locate the TSL fill port on top of the pump and remove the plug.
4. Check that the TSL fluid is up to bottom of the fill port. If not, fill with additional TSL.
5. Replace the TSL fill plug.
6. Replace and secure the module cover.
7. Slide the fluid module back to the operating position and secure the retention bolt.

### NOTICE

If the TSL fluid is discolored (e.g. brown) it can indicate a shaft seal leak. Before servicing the pump drain the TSL from the lower port on the pump and replace it with fresh fluid. If the problem persists the pump must be replaced with a new or rebuilt unit.

## QUICKHEAT™ HOSE CONNECTION DESCRIPTION

1. Cover Screws (x2)
2. Retention Screw
3. TSL Fill Plug
4. TSL Drain Plug

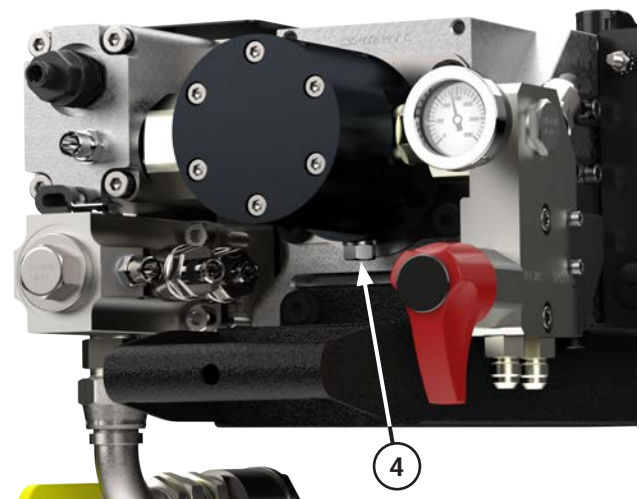
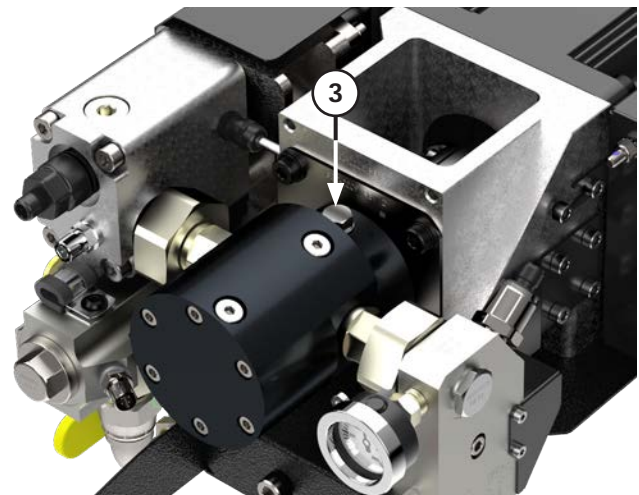



## BURST DISK REPLACEMENT

**Burst Disk Replacement:** As an additional safety precaution against over-pressure conditions, Burst Disk assemblies rated for 7000 psi are located on the back of the A and B High Pressure Manifolds.

If the Burst Disk ruptures, high pressure fluid is contained by a cover and directed downward and away from other equipment or users. Most fluids will not harm the Burst Disk, but some B-side resins can be very caustic (pH above 9) and can, over time, degrade the stainless-steel element contained in the burst disk assembly and cause failure at much lower fluid pressures. For this reason, the burst disk assembly must be replaced annually.

If high pH B-side resins are used, replacement is required monthly or quarterly.

The following steps describe the replacement procedure for the Burst Disk assembly.

1. Press the Stop button on the IS30 screen and turn off the power by rotating the power switch to the Off (O) position.
2. Turn off the supply pump(s) and close the upstream supply valves.
3. Relieve the pressure in the High Pressure Module and distribution (gun) hoses by opening the recirculation valve and/or opening gun manifold material valve(s). Confirm the pressure has been relieved by observing the pressure gauge on the High Pressure Module.
4. Remove the Fluid Module cover. (See previous section for instruction).
5. For easier access, loosen the Fluid Module captive retention screw, pull the spring loaded locking pin, and slide the Fluid Module out until the locking pin engages with the first or second stop. (See previous for instruction).
6. Place a pail or bucket under the High Pressure Module to collect fluid.
7. Remove the two M5 cap head screws and burst disk cover.
8. Use a 7/8" wrench to loosen the Burst Disk assembly two turns and let the remaining high pressure fluid to drip into the collection container.
9. Fully remove the Burst Disk assembly with its O-ring.
10. After the High Pressure Manifold has drained, clean the internal threads and apply ST1 gun grease (or equivalent) to prevent seizing.
11. Apply grease to the threads and O-ring on the new Burst Disk assembly (which includes a new O-ring).
12. Thread the new Burst Disk assembly into the manifold and tighten to 30-35 ft-lbs.
13. Install the Fluid Module cover and secure the captive retention screws.
14. Since some air will have entered the High Pressure module, purge the system by using the Exchange mode through the recirculation line.

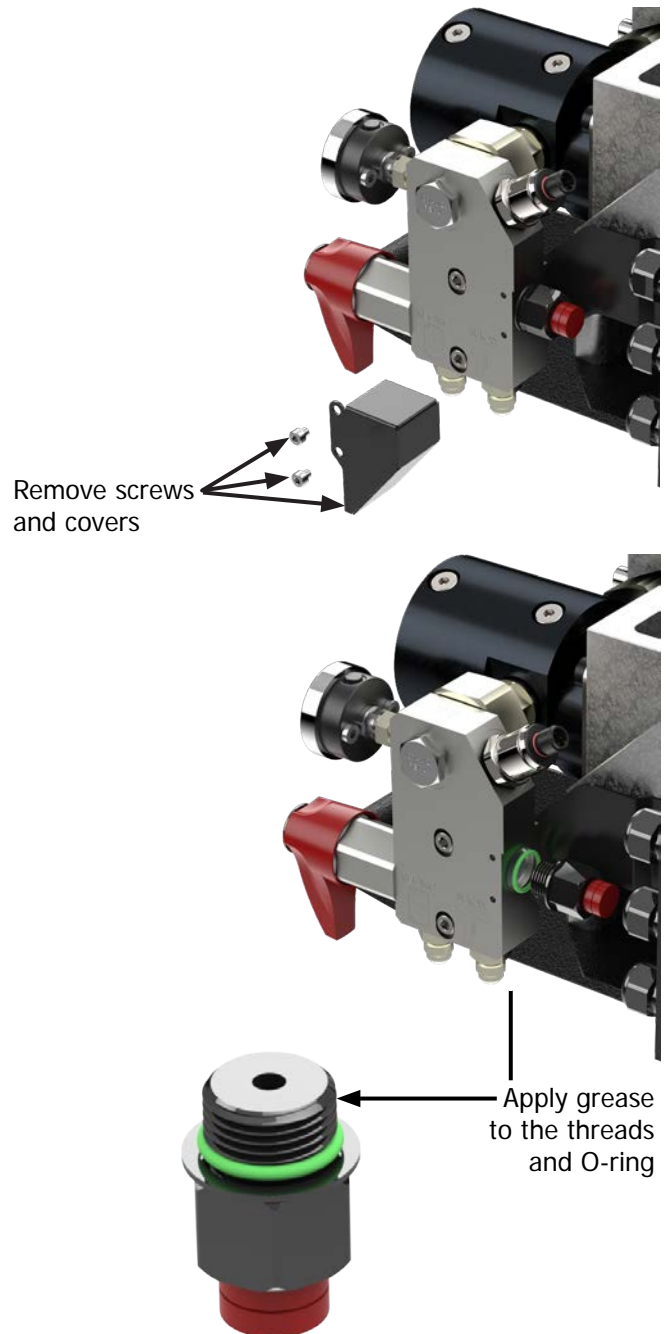

## FILTER MAINTENANCE

**Air Filter Cleaning:** A thermostatically controlled fan in the IS30 Control Module pulls outside cooling air as needed through a reusable air filter at the bottom of the front door. In typical use, removal, cleaning, and reinstallation are recommended every three months. Service should be provided monthly if the IS30 is exposed to particularly dusty environments.

The following steps describe removing, cleaning, and installing the reusable air filter.

Press the "STOP" button on the IS30 screen and turn off power by rotating the power switch to the "OFF" (O) position.

Open the Control Module by rotating the door locks to the open position.

Locate the air filter module on the back of the Control Module door and remove the four (4) right socket head M3 button screws and bracket holding the filter in place.

Remove the filter.

Use a shop vac or compressed air to remove dust and debris from the filter, counter to the flow direction.

Soak the filter in warm soapy water, agitating regularly. Rinse with warm water and repeat until the wash water is clean.

Shake excess water off the filter and allow to dry thoroughly.

Reinstall the filter in reverse order.

Close the Control Module door and secure door locks in closed position.

## FILTER MAINTENANCE DESCRIPTION

1. Door Locks (x2)
2. Power Switch (shown in Off position)
3. Air Filter and Bracket





## SYSTEM ERRORS AND ACTION

When an error occurs, the IS30 automatically enters the "STOP" state and turns off power to heaters and motors. If the system is in an error state, the user must eliminate the error condition and press the "RESET" button before restarting the system.

The Alarm Screen provides users with more information on the error condition and recommended actions. The following tables contain the same information that is displayed for each error.

SYSTEM ERRORS			
Error No.	Alarm Description	Condition	Action
1	Emergency push button is enabled.	Emergency stop button is pressed.	Pull out emergency stop button on front of machine.
2	Drive A Error.	Drive Error "FXXXX."	Power cycle the system, and contact technical service if the problem persists.
3	Drive B Error.	Drive Error "FXXXX."	Power cycle the system, and contact technical service if the problem persists.
4	Pressure Imbalance.	<ol style="list-style-type: none"> <li>A/B pressure difference exceeds the max setpoint.</li> <li>Gun filter is clogged.</li> <li>Gun manifold is closed.</li> <li>Material viscosity is different.</li> </ol>	<ol style="list-style-type: none"> <li>Verify that the gun manifold valves are open.</li> <li>Examine and clean/replace the gun filters.</li> <li>Adjust the material temp setpoints to balance any pressure differences.</li> <li>Enable the AVC mode.</li> <li>Increase the permitted pressure difference in the Recipes Menu.</li> </ol>
5	Material A Below Set Point.	A material level below error setpoint.	Add material or change drum. Update the Gallon Amount.
6	Material B Below Set Point.	B material level below error setpoint.	Add material or change drum. Update the Gallon Amount.
7	Ethercat Bus Error.	Device communication is lost.	Verify that all ethernet (green) cables are properly connected to each port.
8	Drive A Overload Shutdown.	Drive is overloaded.	Reduce the system pressure.
9	Drive B Overload Shutdown.	Drive is overloaded.	Reduce the system pressure.
10	Drive A Amplifier Over Temperature Shutdown.	Drive is overheating.	Reduce the system pressure.
11	Drive B Amplifier Over Temperature Shutdown.	Drive is overheating.	Reduce the system pressure.
12	Drive A Motor Shutdown Temperature.	Motor is overheating.	Reduce the system pressure.
13	Drive B Motor Shutdown Temperature.	Motor is overheating.	Reduce the system pressure.
14	Drive A Control Voltage Error.	Incorrect DC voltage supply.	Verify if the cabinet DC voltage supply is providing 24VDC, and adjust the output if required.
15	Drive B Control Voltage Error.	Incorrect DC voltage supply.	Verify if the cabinet DC voltage supply is providing 24VDC, and adjust the output if required.
16	Drive A Encoder Error.	Motor Encoder Error.	Verify the encoder cable connection at drive and fluid module. Power cycle the system, and contact technical service if the problem persists.
17	Drive B Encoder Error.	Motor Encoder Error.	Verify the encoder cable connection at drive and fluid module. Power cycle the system, and contact technical service if the problem persists.

## SYSTEM ERRORS

Error No.	Alarm Description	Condition	Action
18	Drive A Over Current Error.	Drive is overloaded.	Reduce the system pressure.
19	Drive B Over Current Error.	Drive is overloaded.	Reduce the system pressure.
20	Drive A Over Voltage Error.	Incorrect AC supply voltage.	Verify for correct supply voltage per configuration.
21	Drive B Over Voltage Error.	Incorrect AC supply voltage.	Verify for correct supply voltage per configuration.
22	Drive A Under Voltage Error.	Incorrect AC supply voltage.	Verify for correct supply voltage per configuration.
23	Drive B Under Voltage Error.	Incorrect AC supply voltage.	Verify for correct supply voltage per configuration.
24	Drive A Excessive Deviation.	Pump and motor position position error.	Verify the coupling is properly installed with correct torque settings.
25	Drive B Excessive Deviation.	Pump and motor position position error.	Verify the coupling is properly installed with correct torque settings.
26	Drive A Communication Error.	Lost communication with Drive A.	Verify that the system ethernet cables are connected to the correct ports.
27	Drive B Communication Error.	Lost communication with Drive B.	Verify that the system ethernet cables are connected to the correct ports.
28	Drive A Position Limit Value Exceeded.	Drive A limit exceeded.	Power cycle the system, and contact technical service if the problem persists.
29	Drive B Position Limit Value Exceeded.	Drive B limit exceeded.	Power cycle the system, and contact technical service if the problem persists.
30	System Ratio Error.	<ol style="list-style-type: none"> <li>Air in the lines.</li> <li>Pump Failure.</li> </ol>	<ol style="list-style-type: none"> <li>Purge all the air from the supply lines, proportioner, and hoses.</li> <li>Verify the pump's efficiency and replace the pump if necessary.</li> </ol>
100	Insufficient Drum Pump Pressure A.	<ol style="list-style-type: none"> <li>A drum pump off.</li> <li>A drum pump pressure too low.</li> <li>A inlet valve stuck or closed.</li> <li>Insufficient A material Level.</li> <li>Cold A material.</li> <li>Minimum pressure setting too low.</li> <li>A inlet pressure sensor failure.</li> </ol>	<ol style="list-style-type: none"> <li>Verify that the A drum pump is providing 100 -300 psi at the proportioner.</li> <li>Verify the A supply line valves are open.</li> <li>Examine the A drum material level.</li> <li>Warm the A material to the manufacturer's recommendations.</li> <li>Lower the minimum pressure setting in the Settings screen.</li> <li>Examine the A inlet pressure sensor connectors, and contact technical service if the problem persists.</li> </ol>
101	Excessive System Pressure A Post-Gear Pump.	<ol style="list-style-type: none"> <li>A side pressure exceeds maximum system setpoint.</li> <li>A side gun manifold valve turned off.</li> <li>A side gun filter clogged.</li> <li>A post gear pump pressure sensor failure.</li> <li>B recirculation valve is open or stuck.</li> </ol>	<ol style="list-style-type: none"> <li>Lower the system pressure set point.</li> <li>Raise the pressure error limit in the Recipes screen.</li> <li>Verify the A side gun manifold is in the open position.</li> <li>Clean or replace the A side gun filter.</li> <li>Examine the A side outlet pressure sensor connector.</li> <li>Verify that the B side recirculation valve is not stuck and is in the gun position.</li> </ol>
103	Hose OverTemp A End Modem.	<ol style="list-style-type: none"> <li>Hose overheat due to ambient conditions.</li> <li>Heater cable connected to the incorrect section.</li> </ol>	<ol style="list-style-type: none"> <li>Let the hose cool (and/or purge fluid through the hose).</li> <li>Examine the hose power connections.</li> </ol>

SYSTEM ERRORS			
Error No.	Alarm Description	Condition	Action
104	PreHeat Overtemp A.	<ol style="list-style-type: none"> <li>1. Preheater A is too hot.</li> <li>2. Temperature sensor failure.</li> </ol>	<ol style="list-style-type: none"> <li>1. Let the preheater (and/or purge fluid through the preheater).</li> <li>2. Examine the temperature sensor connector.</li> </ol>
105	Filter Clog A.	<ol style="list-style-type: none"> <li>1. Filter clogged.</li> <li>2. Pressure drop error setting too low.</li> <li>3. Pressure sensor failure.</li> </ol>	<ol style="list-style-type: none"> <li>1. Clean or replace the filter element.</li> <li>2. Increase the maximum permitted pressure drop in the Recipes screen.</li> <li>3. Examine the inlet and outlet pressure sensor connectors.</li> </ol>
106	Insufficient Preheat Pressure A.	<ol style="list-style-type: none"> <li>1. A drum pump off.</li> <li>2. A drum pump pressure too low.</li> <li>3. A supply line, pre-filter, and/or post-filter valve closed.</li> <li>4. Insufficient A material Level.</li> <li>5. Cold A material.</li> <li>6. Minimum pressure setting too low.</li> <li>7. A inlet pressure sensor failure.</li> <li>8. Pressure sensor failure.</li> <li>9. A pre-filter or inlet valve clogged.</li> <li>10. A flow meter stuck.</li> </ol>	<ol style="list-style-type: none"> <li>1. Verify that the A drum pump is providing 100 -300 psi at the proportioner.</li> <li>2. Verify that the A inlet and filter valves are open.</li> <li>3. Examine the A drum material level.</li> <li>4. Warm the A material to the manufacturer's recommendations.</li> <li>5. Lower the minimum pressure error setting in the Settings screen.</li> <li>6. Examine the A pressure sensor connectors.</li> <li>7. Clean or replace the A inlet filter.</li> <li>8. Remove the A filter inlet valve and examine it for debris.</li> <li>9. Remove A flow meter and check for solids of debris.</li> </ol>
107	Insufficient Filter Pressure A.	<ol style="list-style-type: none"> <li>1. A drum pump off.</li> <li>2. A drum pump pressure too low.</li> <li>3. A supply line or pre-filter valve closed.</li> <li>4. Insufficient A material Level.</li> <li>5. Cold A material.</li> <li>6. Minimum pressure setting too low.</li> <li>7. Pressure sensor failure.</li> <li>8. A pre-filter or inlet valve logged.</li> </ol>	<ol style="list-style-type: none"> <li>1. Verify that the A drum pump is providing 100 -300 psi at the proportioner.</li> <li>2. Verify that the A inlet and filter valves are open.</li> <li>3. Examine the A drum material level.</li> <li>4. Warm the A material to the manufacturer's recommendations.</li> <li>5. Lower the minimum pressure error setting in the Settings screen.</li> <li>6. Examine the A pressure sensor connectors.</li> <li>7. Clean or replace the A inlet filter.</li> <li>8. Remove the A filter inlet valve and examine it for debris.</li> </ol>
108	Excessive Drum Pump Pressure A.	<ol style="list-style-type: none"> <li>1. A drum pump pressure too high.</li> <li>2. Pressure sensor failure.</li> <li>3. A check valve leak.</li> </ol>	<ol style="list-style-type: none"> <li>1. Verify that the A drum pump is providing 100 -300 psi at the proportioner.</li> <li>2. Increase the maximum inlet pressure setting in the Settings screen.</li> <li>3. Examine the A inlet pressure sensor connector.</li> <li>4. Examine the A side high-pressure check valve and replace if necessary.</li> </ol>

## SYSTEM ERRORS

Error No.	Alarm Description	Condition	Action
109	Excessive System Pressure A SMOSE.	<ol style="list-style-type: none"> <li>1. A side pressure exceeds maximum system setpoint.</li> <li>2. A side gun manifold valve turned off.</li> <li>3. A side gun filter clogged.</li> <li>4. B side recirculation valve in open (recirculation) position.</li> <li>5. Hose pressure sensor not calibrated.</li> <li>6. Hose pressure sensor failure.</li> </ol>	<ol style="list-style-type: none"> <li>1. Lower the pressure set point.</li> <li>2. Raise the pressure error limit in the Recipes screen.</li> <li>3. Verify the A side gun manifold is in the open position.</li> <li>4. Clean or replace the A side gun filter.</li> <li>5. Examine that the B side recirculation valve is in the hose (gun) position.</li> <li>6. Verify the hose calibration (see Hose Calibration in the System Screen).</li> </ol>
110	A Flow Meter Error.	Flow meter failure.	Examine the A flow meter and the connector.
111	A Pre-Heat RTD Body Top Error.	Sensor failure.	Examine the RTD sensor and connector.
112	A Pre-Heat RTD Body Bottom Error.	Sensor failure.	Examine the RTD sensor and connector.
113	A Pre-Heat RTD In Error.	Sensor failure.	Examine the RTD sensor and connector.
114	A Pre-Heat RTD Out Error.	Sensor failure.	Examine the RTD sensor and connector.
115	A Pre-Filter Pressure Sensor Error.	<ol style="list-style-type: none"> <li>1. Excessive Pressure.</li> <li>2. Pressure below zero.</li> <li>3. Sensor failure.</li> </ol>	<ol style="list-style-type: none"> <li>1. Examine the check valve and replace if not holding pressure.</li> <li>2. Examine for cavitation.</li> <li>3. Examine the connector.</li> <li>4. Replace the sensor.</li> </ol>
116	A Post-Filter Pressure Sensor Error.	<ol style="list-style-type: none"> <li>1. Excessive Pressure.</li> <li>2. Pressure below zero.</li> <li>3. Sensor failure.</li> </ol>	<ol style="list-style-type: none"> <li>1. Examine the check valve and replace if not holding pressure.</li> <li>2. Examine for cavitation.</li> <li>3. Examine the connector.</li> <li>4. Replace the sensor.</li> </ol>
117	A Pre-Gear Pump Pressure Sensor Error.	Sensor failure.	<ol style="list-style-type: none"> <li>1. Examine the check valve and pressure sensor and replace if not holding pressure.</li> <li>2. Examine for cavitation.</li> <li>3. Examine the connector.</li> <li>4. Replace the sensor.</li> </ol>
118	A Post-Gear Pump Pressure Sensor Error.	Sensor failure.	<ol style="list-style-type: none"> <li>1. Verify pressure reading matches the analog pressure gauge</li> <li>2. Examine for cavitation.</li> <li>3. Examine the connector.</li> <li>4. Replace the sensor.</li> </ol>
119	Hose UnderTemp A Middle 1 Modem.	<ol style="list-style-type: none"> <li>1. Heater cable disconnected or connected to the incorrect section.</li> <li>2. Hose heater wire failure.</li> </ol>	Examine the hose power connections.
120	Hose OverTemp A Middle 1 Modem.	<ol style="list-style-type: none"> <li>1. Hose overheat due to ambient conditions.</li> <li>2. Heater cable connected to the incorrect section.</li> </ol>	<ol style="list-style-type: none"> <li>1. Let the system cool and/or purge the material.</li> <li>2. Examine the heater cable connections.</li> </ol>

SYSTEM ERRORS			
Error No.	Alarm Description	Condition	Action
200	Insufficient Drum Pump Pressure B.	<ol style="list-style-type: none"> <li>1. B drum pump off.</li> <li>2. B drum pump pressure too low.</li> <li>3. B inlet valve stuck or closed.</li> <li>4. Insufficient B material Level.</li> <li>5. Cold B material.</li> <li>6. Minimum pressure setting too low.</li> <li>7. B inlet pressure sensor failure.</li> </ol>	<ol style="list-style-type: none"> <li>1. Verify that the B drum pump is providing 100 -300 psi at the proportioner.</li> <li>2. Verify that the B supply line valves are open.</li> <li>3. Examine the B drum material level.</li> <li>4. Warm the B material to the manufacturer's recommendations.</li> <li>5. Lower the minimum pressure setting in the Settings screen.</li> <li>6. Examine the B inlet pressure sensor connectors, and contact technical service if the problem persists.</li> </ol>
201	Excessive System Pressure B Post-Gear Pump.	<ol style="list-style-type: none"> <li>1. B side pressure exceeds maximum system setpoint.</li> <li>2. B post gear pump pressure sensor failure.</li> </ol>	<ol style="list-style-type: none"> <li>1. Lower the system pressure set point.</li> <li>2. Raise the system pressure error limit in the Recipes screen.</li> <li>3. Examine the B side outlet pressure sensor connector.</li> </ol>
202	Hose Under Temp B End Modem.	<ol style="list-style-type: none"> <li>1. Heater cable disconnected or connected to the incorrect section.</li> <li>2. Hose heater wire failure.</li> </ol>	<ol style="list-style-type: none"> <li>1. Examine the hose power connections. Contact technical service if the problem persists.</li> </ol>
203	Hose OverTemp B End Modem.	<ol style="list-style-type: none"> <li>1. Hose overheat due to ambient conditions.</li> <li>2. Heater cable connected to the incorrect section.</li> </ol>	<ol style="list-style-type: none"> <li>1. Let the hose cool (and/or purge fluid through the hose).</li> <li>2. Examine the hose power connections.</li> </ol>
204	PreHeat Overtemp B.	<ol style="list-style-type: none"> <li>1. Preheater B too hot.</li> <li>2. Temperature sensor failure.</li> </ol>	<ol style="list-style-type: none"> <li>1. Let the preheater cool (and/or purge fluid through pre-heater).</li> <li>2. Examine the temperature sensor connector.</li> </ol>
205	Filter Clog B.	<ol style="list-style-type: none"> <li>1. Filter clogged.</li> <li>2. Pressure drop error setting too low.</li> <li>3. Pressure sensor failure.</li> </ol>	<ol style="list-style-type: none"> <li>1. Clean or replace the filter element.</li> <li>2. Increase the maximum permitted pressure drop in the Recipes screen.</li> <li>3. Examine the inlet and outlet pressure sensor connectors.</li> </ol>
206	Insufficient Preheater Pressure B.	<ol style="list-style-type: none"> <li>1. B drum pump off.</li> <li>2. B drum pump pressure too low.</li> <li>3. B supply line, pre-filter, and/or post-filter valve closed.</li> <li>4. Insufficient B material Level.</li> <li>5. Cold B material.</li> <li>6. Minimum pressure setting too low.</li> <li>7. B inlet pressure sensor failure.</li> <li>8. Pressure sensor failure.</li> <li>9. B pre-filter or inlet valve logged.</li> <li>10. B flow meter stuck.</li> </ol>	<ol style="list-style-type: none"> <li>1. Verify that the B drum pump is providing 100 -300 psi at the proportioner.</li> <li>2. Verify the B inlet and filter valves are open.</li> <li>3. Examine the B drum material level.</li> <li>4. Warm the B material to the manufacturer's recommendations.</li> <li>5. Lower the minimum pressure error setting in the Settings screen.</li> <li>6. Examine the B pressure sensor connectors.</li> <li>7. Clean or replace the B inlet filter.</li> <li>8. Remove the B filter inlet valve and examine it for debris.</li> <li>9. Remove the B flow meter and examine it for solids of debris.</li> </ol>

## SYSTEM ERRORS

Error No.	Alarm Description	Condition	Action
207	Insufficient Filter Pressure B.	<ol style="list-style-type: none"> <li>1. B drum pump off.</li> <li>2. B drum pump pressure too low.</li> <li>3. B supply line or pre-filter valve closed.</li> <li>4. Insufficient B material Level.</li> <li>5. Cold B material.</li> <li>6. Minimum pressure setting too low.</li> <li>7. Pressure sensor failure.</li> <li>8. B pre-filter or inlet valve logged.</li> </ol>	<ol style="list-style-type: none"> <li>1. Verify that the B drum pump is providing 100 -300 psi at the proportioner.</li> <li>2. Verify the B inlet and filter valves are open.</li> <li>3. Examine the B drum material level.</li> <li>4. Warm the B material to the manufacturer's recommendations.</li> <li>5. Lower the minimum pressure error setting in the Settings screen.</li> <li>6. Examine the B pressure sensor connectors.</li> <li>7. Clean or replace the B inlet filter.</li> <li>8. Remove the B filter inlet valve and examine it for debris.</li> </ol>
208	Excessive Drum Pump Pressure B.	<ol style="list-style-type: none"> <li>1. B drum pump pressure too high.</li> <li>2. Pressure sensor failure.</li> <li>3. B high-pressure check valve leak.</li> </ol>	<ol style="list-style-type: none"> <li>1. Examine that the B pump is pressurized to provide 100-300 psi at the system.</li> <li>2. Examine the B inlet pressure sensor connector.</li> <li>3. Verify or replace the B side high-pressure check valve.</li> </ol>
209	Excessive System Pressure B SMOSE.	<ol style="list-style-type: none"> <li>1. B drum pump pressure too high.</li> <li>2. Pressure sensor failure.</li> <li>3. B check valve leak.</li> </ol>	<ol style="list-style-type: none"> <li>1. Verify that the B drum pump is providing 100 -300 psi at the proportioner.</li> <li>2. Increase the maximum inlet pressure setting in the Settings screen.</li> <li>3. Examine the B inlet pressure sensor connector.</li> <li>4. Verify or replace the B side high-pressure check valve.</li> <li>5. Examine that the B side recirculation valve is in the hose (gun) position.</li> <li>6. Verify the hose calibration (see Hose Calibration in the System Screen).</li> </ol>
210	B Flow Meter Error.	Flow meter failure.	Examine the B flow meter and the connector.
211	B Pre-Heat RTD Body Top Error.	Sensor failure.	Examine the RTD sensor and connector.
212	B Pre-Heat RTD Body Bottom Error.	Sensor failure.	Examine the RTD sensor and connector.
213	B Pre-Heat RTD In Error.	Sensor failure.	Examine the RTD sensor and connector.
214	B Pre-Heat RTD Out Error.	Sensor failure.	Examine the RTD sensor and connector.
215	B Pre-Filter Pressure Sensor Error.	<ol style="list-style-type: none"> <li>1. Excessive Pressure.</li> <li>2. Pressure below zero.</li> <li>3. Sensor failure.</li> </ol>	<ol style="list-style-type: none"> <li>1. Examine the check valve and replace if not holding pressure.</li> <li>2. Examine for cavitation.</li> <li>3. Examine the connector.</li> <li>4. Replace the sensor.</li> </ol>
216	B Post-Filter Pressure Sensor Error.	<ol style="list-style-type: none"> <li>1. Excessive Pressure.</li> <li>2. Pressure below zero.</li> <li>3. Sensor failure.</li> </ol>	<ol style="list-style-type: none"> <li>1. Examine the check valve and replace if not holding pressure.</li> <li>2. Examine for cavitation.</li> <li>3. Examine the connector.</li> <li>4. Replace the sensor.</li> </ol>
217	B Pre-Gear Pump Pressure Sensor Error.	Sensor failure.	Examine the pressure sensor and connector.



SYSTEM ERRORS			
Error No.	Alarm Description	Condition	Action
218	B Post-Gear Pump Pressure Sensor Error.	Sensor failure.	<ol style="list-style-type: none"> <li>1. Verify pressure reading matches the analog pressure gauge</li> <li>2. Examine for cavitation.</li> <li>3. Examine the connector.</li> <li>4. Replace the sensor.</li> </ol>
219	Hose Under Temp B Middle 1 Modem.	<ol style="list-style-type: none"> <li>1. Heater cable disconnected or connected to the incorrect section.</li> <li>2. Hose heater wire failure.</li> </ol>	Examine the hose power connections.
220	Hose OverTemp B Middle 1 Modem.	<ol style="list-style-type: none"> <li>1. Hose overheat due to ambient conditions.</li> <li>2. Heater cable connected to the incorrect section.</li> </ol>	<ol style="list-style-type: none"> <li>1. Let the system cool and/or purge the material.</li> <li>2. Examine the heater cable connections.</li> </ol>
300	SMOSE MM - Yamar chip failed to initialize.	Hardware failure.	Cycle the power.
301	SMOSE MM - No PLC packets received.	<ol style="list-style-type: none"> <li>1. Frequency setting not optimal.</li> <li>2. Interference from other nearby systems.</li> <li>3. Modems not paired correctly.</li> <li>4. Incorrect hose configuration setting.</li> <li>4. Hardware failure.</li> </ol>	<ol style="list-style-type: none"> <li>1. Reposition the hose (uncoil fully).</li> <li>2. Examine the hose configuration (see the Hose Configuration screen).</li> <li>3. Pair, scan, and set the hose frequencies (see the Hose Configuration screen).</li> </ol>
302	SMOSE MM - Timeout waiting for Tx complete Interrupt.	Hardware failure.	Cycle the power.
303	SMOSE MM - Multiple master modems detected on RF link.	<ol style="list-style-type: none"> <li>1. Multiple systems in close proximity operating on the same frequency.</li> <li>2. Modems not paired correctly.</li> </ol>	<ol style="list-style-type: none"> <li>1. Move one system to a different frequency (see the Hose Configuration screen).</li> <li>2. Pair the modems (see the Hose Configuration screen).</li> </ol>
304	SMOSE MM - Arbitration lost (bus may be shorted to GND or VDD).	Bad connection between modem A and B sides.	<ol style="list-style-type: none"> <li>1. Examine the modem connection cable.</li> <li>2. Cycle the power.</li> </ol>
305	SMOSE MM - No ACK from device (Verify I2C address for device is set correctly).	Bad connection between modem A and B sides.	<ol style="list-style-type: none"> <li>1. Examine the modem connection cable.</li> <li>2. Cycle the power.</li> </ol>
306	SMOSE MM - Timeout during I2C data transfer.	Bad connection between modem A and B sides.	<ol style="list-style-type: none"> <li>1. Examine the modem connection cable.</li> <li>2. Cycle the power.</li> </ol>
307	SMOSE MM - Other errors: OverUnderRun, DMA Error or Bus Error.	Bad connection between modem A and B sides.	<ol style="list-style-type: none"> <li>1. Examine the modem connection cable.</li> <li>2. Cycle the power.</li> </ol>
308	SMOSE MM - No pressure data from sensor (I2C read failure).	Bad connection between modem A and B sides.	<ol style="list-style-type: none"> <li>1. Examine the modem connection cable.</li> <li>2. Cycle the power.</li> </ol>
309	SMOSE MM - Hose A pressure out of range.	Pressure sensor out of calibration.	Calibrate the sensor (see the Hose Configuration screen).
310	SMOSE MM - Hose B pressure out of range.	Pressure sensor out of calibration.	Calibrate the sensor (see the Hose Configuration screen).
311	SMOSE MM - No Temperature data from sensor (I2C read failure).	Bad connection between modem A and B sides.	<ol style="list-style-type: none"> <li>1. Examine the modem connection cable.</li> <li>2. Cycle the power.</li> </ol>
312	SMOSE MM - Hose A temperature out of range.	Hardware failure.	Cycle the power.
313	SMOSE MM - Hose B temperature out of range.	Hardware failure.	Cycle the power.

## SYSTEM ERRORS

Error No.	Alarm Description	Condition	Action
314	SMOSE MM - Event Memory Pool is empty.	Firmware error.	Cycle the power. Contact technical service and enable limp mode.
315	SMOSE MM - Flash Parameter Storage system error.	Bad connection between modem A and B sides.	1. Examine the modem connection cable. 2. Cycle the power.
316	SMOSE MM - Error during DMA transfer.	Bad connection between modem A and B sides.	1. Examine the modem connection cable. 2. Cycle the power.
317	SMOSE MM - EtherCAT chip failed to initialize End and Mid Modems: Not Applicable.	Hardware failure.	Cycle the power.
318	SMOSE MM - EtherCAT no Network link End and Mid Modems Not Applicable.	1. No network connection between HMI and Main modem. 2. Hardware Failure.	1. Examine the network connection to the main modem. 2. Cycle the power.
319	SMOSE MM - Other uncategorized error condition.	Hardware failure.	Cycle the power.
320	SMOSE MM - Arbitration lost (bus may be shorted to GND or VDD).	Bad connection between modem A and B sides.	1. Examine the modem connection cable. 2. Cycle the power.
321	SMOSE MM - No ACK from device (Verify I2C address for device is set correctly).	1. Bad connection between modem A and B sides. 2. Hardware failure.	1. Verify that the connection contacts are clean and secure between the A and B sides of the modem. 2. Cycle the power.
322	SMOSE MM - Timeout during I2C data transfer.	Bad connection between modem A and B sides.	1. Examine the modem connection cable. 2. Cycle the power.
323	SMOSE MM - Other errors: OverUnderRun, DMA Error or Bus Error.	Bad connection between modem A and B sides.	1. Examine the modem connection cable. 2. Cycle the power.
324	SMOSE MM - Arbitration lost (bus may be shorted to GND or VDD).	Bad connection between modem A and B sides.	1. Examine the modem connection cable. 2. Cycle the power.
325	SMOSE MM - No ACK from device (Verify I2C address is correct).	1. Bad connection between modem A and B sides. 2. Hardware failure.	1. Verify that the connection contacts are clean and secure between the A and B sides of the modem.
326	SMOSE MM - Timeout during I2C data transfer.	Bad connection between modem A and B sides.	1. Examine the modem connection cable. 2. Cycle the power.
327	SMOSE MM - Other errors: OverUnderRun, DMA Error or Bus Error.	Bad connection between modem A and B sides.	1. Examine the modem connection cable. 2. Cycle the power.
400	SMOSE M1 - Yamar chip failed to initialize.	Hardware failure.	Cycle the power.
401	SMOSE M1 - No PLC packets received.	1. Frequency setting not optimal. 2. Interference from other nearby systems. 3. Modems not paired correctly. 4. Incorrect hose configuration setting. 5. Hardware failure.	1. Reposition the hose (uncoil fully). 2. Examine the hose configuration (see the Hose Configuration screen). 3. Pair, scan, and set the hose frequencies (see the Hose Configuration screen).
402	SMOSE M1 - Timeout waiting for Tx complete Interrupt.	Hardware failure.	Cycle the power.

SYSTEM ERRORS			
Error No.	Alarm Description	Condition	Action
403	SMOSE M1 - Multiple master modems detected on RF link.	Bad connection between modem A and B sides.	1. Examine the modem connection cable. 2. Cycle the power.
404	SMOSE M1 - Arbitration lost (bus may be shorted to GND or VDD).	Bad connection between modem A and B sides.	1. Examine the modem connection cable. 2. Cycle the power.
405	SMOSE M1 - No ACK from device (Verify I2C address for device is set correctly).	Bad connection between modem A and B sides.	1. Examine the modem connection cable. 2. Cycle the power.
406	SMOSE M1 - Timeout during I2C data transfer.	Bad connection between modem A and B sides.	1. Examine the modem connection cable. 2. Cycle the power.
407	SMOSE M1 - Other errors: OverUnderRun, DMA Error or Bus Error.	Bad connection between modem A and B sides.	1. Examine the modem connection cable. 2. Cycle the power.
408	SMOSE M1 - No pressure data from sensor.	Bad connection between modem A and B sides.	1. Examine the modem connection cable. 2. Cycle the power.
409	SMOSE M1 - Hose A pressure out of range.	Pressure sensor out of calibration.	Calibrate the sensor.
410	SMOSE M1 - Hose B pressure out of range.	Pressure sensor out of calibration.	Calibrate the sensor.
411	SMOSE M1 - No Temperature data from sensor.	Bad connection between modem A and B sides.	1. Examine the modem connection cable. 2. Cycle the power.
412	SMOSE M1 - Hose A temperature out of range.	Hardware failure.	Cycle the power.
413	SMOSE M1 - Hose B temperature out of range.	Hardware failure.	Cycle the power.
414	SMOSE M1 - Event Memory Pool is empty.	Firmware issue.	Cycle the power.
415	SMOSE M1 - Flash Parameter Storage system error.	Bad connection between modem A and B sides.	1. Examine the modem connection cable. 2. Cycle the power.
416	SMOSE M1 - Error during DMA transfer.	Bad connection between modem A and B sides.	1. Examine the modem connection cable. 2. Cycle the power.
417	SMOSE M1 - EtherCAT chip failed to initialize. End and Mid Modems: Not Applicable.	Hardware failure.	Cycle the power.
418	SMOSE M1 - EtherCAT no Network link. End and Mid Modems Not Applicable.	1. No network connection between HMI and Main modem. 2. Hardware Failure.	1. Examine the network connection to the main modem. 2. Cycle the power.
419	SMOSE M1 - Other uncategorized error condition.	Hardware failure.	Cycle the power.
420	SMOSE M1 - Arbitration lost (bus may be shorted to GND or VDD).	Bad connection between modem A and B sides	1. Examine the modem connection cable. 2. Cycle the power.
421	SMOSE M1 - No ACK from device.	Bad connection between modem A and B sides	1. Examine the modem connection cable. 2. Cycle the power.
422	SMOSE M1 - Timeout during I2C data transfer.	Bad connection between modem A and B sides	1. Examine the modem connection cable. 2. Cycle the power.

## SYSTEM ERRORS

Error No.	Alarm Description	Condition	Action
423	SMOSE M1 - Other errors: OverUnderRun, DMA Error or Bus Error.	Bad connection between modem A and B sides.	<ol style="list-style-type: none"> <li>1. Examine the modem connection cable.</li> <li>2. Cycle the power.</li> </ol>
424	SMOSE M1 - Arbitration lost (bus may be shorted to GND or VDD).	Bad connection between modem A and B sides.	<ol style="list-style-type: none"> <li>1. Examine the modem connection cable.</li> <li>2. Cycle the power.</li> </ol>
425	SMOSE M1 - No ACK from device.	Bad connection between modem A and B sides.	<ol style="list-style-type: none"> <li>1. Examine the modem connection cable.</li> <li>2. Cycle the power.</li> </ol>
426	SMOSE M1 - Timeout during I2C data transfer.	Bad connection between modem A and B sides.	<ol style="list-style-type: none"> <li>1. Examine the modem connection cable.</li> <li>2. Cycle the power.</li> </ol>
427	SMOSE M1 - Other errors: OverUnderRun, DMA Error or Bus Error.	Bad connection between modem A and B sides.	<ol style="list-style-type: none"> <li>1. Examine the modem connection cable.</li> <li>2. Cycle the power.</li> </ol>
600	SMOSE ME - Yamar chip failed to initialize.	Hardware failure.	Cycle the power.
601	SMOSE ME - No PLC packets received.	<ol style="list-style-type: none"> <li>1. Frequency setting not optimal.</li> <li>2. Interference from other nearby systems.</li> <li>3. Modems not paired correctly.</li> <li>4. Incorrect hose configuration setting.</li> <li>5. Hardware failure.</li> </ol>	<ol style="list-style-type: none"> <li>1. Reposition the hose (uncoil fully).</li> <li>2. Examine the hose configuration (see the Hose Configuration screen).</li> <li>3. Pair, scan, and set the hose frequencies (see the Hose Configuration screen).</li> </ol>
602	SMOSE ME - Timeout waiting for Tx complete Interrupt.	Hardware failure.	Cycle the power.
603	SMOSE ME - Multiple master modems detected on RF link.	<ol style="list-style-type: none"> <li>1. Multiple systems in close proximity operating on the same frequency.</li> <li>2. Modems not paired correctly.</li> </ol>	<ol style="list-style-type: none"> <li>1. Move one system to a different frequency.</li> <li>2. Pair the modems.</li> </ol>
604	SMOSE ME - Arbitration lost (bus may be shorted to GND or VDD).	Bad connection between modem A and B sides.	<ol style="list-style-type: none"> <li>1. Examine the modem connection cable.</li> <li>2. Cycle the power.</li> </ol>
605	SMOSE ME - No ACK from device (Verify I2C address for device is set correctly).	Bad connection between modem A and B sides.	<ol style="list-style-type: none"> <li>1. Examine the modem connection cable.</li> <li>2. Cycle the power.</li> </ol>
606	SMOSE ME - Timeout during I2C data transfer.	Bad connection between modem A and B sides.	<ol style="list-style-type: none"> <li>1. Examine the modem connection cable.</li> <li>2. Cycle the power.</li> </ol>
607	SMOSE ME - Other errors: OverUnderRun, DMA Error or Bus Error.	Bad connection between modem A and B sides.	<ol style="list-style-type: none"> <li>1. Examine the modem connection cable.</li> <li>2. Cycle the power.</li> </ol>
608	SMOSE ME - No pressure data from sensor (I2C read failure).	Bad connection between modem A and B sides.	<ol style="list-style-type: none"> <li>1. Examine the modem connection cable.</li> <li>2. Cycle the power.</li> </ol>
609	SMOSE ME - Hose A pressure out of range.	Pressure sensor out of calibration.	Calibrate the sensor.
610	SMOSE ME - Hose B pressure out of range.	Pressure sensor out of calibration.	Calibrate the sensor
611	SMOSE ME - No Temperature data from sensor (I2C read failure).	<ol style="list-style-type: none"> <li>1. Bad connection between modem A and B sides.</li> <li>2. Hardware failure.</li> </ol>	<ol style="list-style-type: none"> <li>1. Verify that the connection contacts are clean and secure between the A and B sides of the modem.</li> </ol>

SYSTEM ERRORS			
Error No.	Alarm Description	Condition	Action
612	SMOSE ME - Hose A temperature out of range.	Hardware Failure.	Cycle the power.
613	SMOSE ME - Hose B temperature out of range.	Hardware Failure.	Cycle the power.
614	SMOSE ME - Event Memory Pool is empty.	Firmware Failure.	Cycle the power.
615	SMOSE ME - Flash Parameter Storage system error.	Bad connection between modem A and B sides.	1. Examine the modem connection cable. 2. Cycle the power.
616	SMOSE ME - Error during DMA transfer.	Bad connection between modem A and B sides.	1. Examine the modem connection cable. 2. Cycle the power.
617	SMOSE ME - EtherCAT chip failed to initialize End and Mid Modems: Not Applicable.	Hardware failure.	Cycle the power.
618	SMOSE ME - EtherCAT no Network link End and Mid Modems Not Applicable.	Bad connection between modem A and B sides.	1. Examine the modem connection cable. 2. Cycle the power.
619	SMOSE ME - Other uncategorized error condition.	Hardware failure.	Cycle the power.
620	SMOSE ME - Arbitration lost (bus may be shorted to GND or VDD).	Bad connection between modem A and B sides.	1. Examine the modem connection cable. 2. Cycle the power.
621	SMOSE ME - No ACK from device (Verify I2C address for device is set correctly).	Bad connection between modem A and B sides.	1. Examine the modem connection cable. 2. Cycle the power.
622	SMOSE ME - Timeout during I2C data transfer.	Bad connection between modem A and B sides.	1. Examine the modem connection cable. 2. Cycle the power.
623	SMOSE ME - Other errors: OverUnderRun, DMA Error or Bus Error.	Bad connection between modem A and B sides.	1. Examine the modem connection cable. 2. Cycle the power.
624	SMOSE ME - Arbitration lost (bus may be shorted to GND or VDD).	Bad connection between modem A and B sides.	1. Examine the modem connection cable. 2. Cycle the power.
625	SMOSE ME - No ACK from device (Verify I2C address is correct).	Bad connection between modem A and B sides.	1. Examine the modem connection cable. 2. Cycle the power.
626	SMOSE ME - Timeout during I2C data transfer.	Bad connection between modem A and B sides.	1. Examine the modem connection cable. 2. Cycle the power.
627	SMOSE ME - Other errors: OverUnderRun, DMA Error or Bus Error.	Bad connection between modem A and B sides.	1. Examine the modem connection cable. 2. Cycle the power.

This page intentionally left blank.



## REGULAR MAINTENANCE PROCEDURES AND RECOMMENDATIONS

### Material Purge

Thoroughly purge the system after job completion. Failure to do so can cause clogs, leaks, or cross-contamination of materials when the system is disassembled for servicing.

### Regular Inspection

Continuous use or lack of use of the system can cause a system malfunction. Do regular interval system inspections as shown at the table below.

MAINTENANCE INTERVALS		
Frequency	Description	Inspection Method
DAILY	SYSTEM FLUSHED WITH SOLVENT	VISUAL
DAILY	CHECK FOR LEAKS	VISUAL
DAILY	CLEAN SPRAY GUNS	VISUAL
DAILY	CHECK ALARM HISTORY	VISUAL
DAILY	CHECK FOR MATERIAL SUPPLY	VISUAL
MONTHLY	CHECK FILTER BODY AND MESH SCREEN FOR CLOGS	VISUAL
MONTHLY	CHECK ALL HOSES FOR KINKS AND WEAR	VISUAL
MONTHLY	PERFORM LOW PRESSURE MODULE CALIBRATION CHECK	COMPARE THE ANALOG PRESSURE INDICATION WITH THE HMI PRESSURE INDICATION
MONTHLY	PERFORM HIGH PRESSURE MODULE CALIBRATION CHECK	COMPARE THE ANALOG PRESSURE INDICATION WITH THE HMI PRESSURE INDICATION
MONTHLY	PERFORM PUMP MODULE CALIBRATION CHECK	COMPARE THE ANALOG PRESSURE INDICATION WITH THE HMI PRESSURE INDICATION
MONTHLY	PERFORM PUMP I/O MODULE CALIBRATION CHECK	COMPARE THE ANALOG PRESSURE INDICATION WITH THE HMI PRESSURE INDICATION
MONTHLY	CHECK FLUID MODULE OPERATION	TRIGGER MANUALLY OR FROM HMI
MONTHLY	CHECK RECIRCULATION VALVE OPERATION	CHECK MANUALLY
MONTHLY	CLEAN FLUID MODULES AND CHECK VALVES & SEALS	DISASSEMBLE
MONTHLY	CHECK A/B FLUID HOSES FOR MATERIAL BUILDUP	DISASSEMBLE
AS NEEDED	REBUILD FLUID MODULES	DISASSEMBLE

FLUID MODULE ITEMS

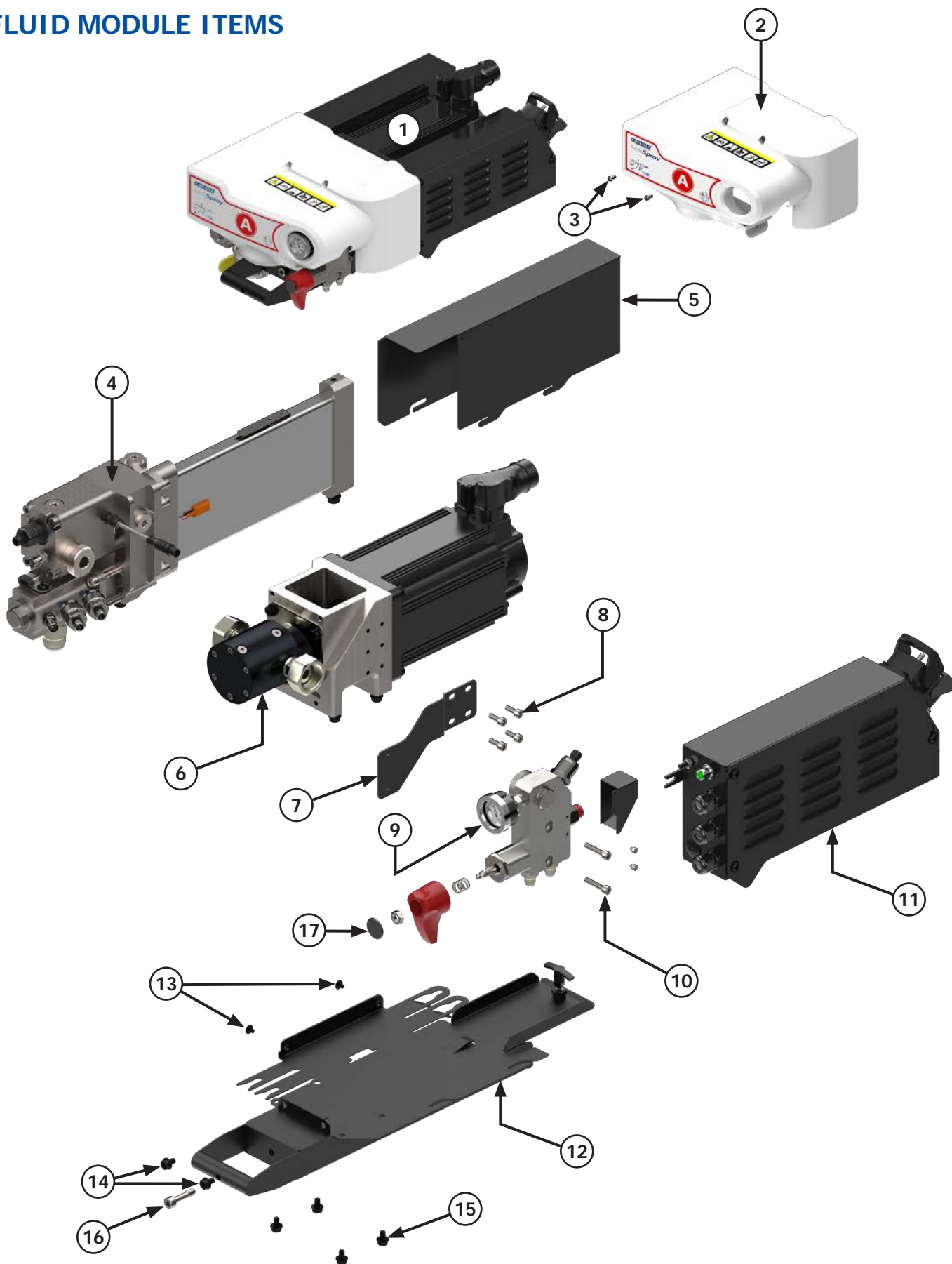

FLUID MODULE ITEMS			
Item	P/N	Description	Qty Used (Per Module)
1	347484 347485	A SIDE FLUID MODULE B SIDE FLUID MODULE	1
2	347494 347495	A SIDE FLUID MODULE COVER (INCL. 3) B SIDE FLUID MODULE COVER (INCL. 3)	1
3	NA	BUTTON HEAD SCREW, M6 x 1.0 x 12 LG, SST	2
4	347496	LOW PRESSURE MODULE POPULATED	1
5	347497	PREHEATER MODULE COVER	1
6	347498	PUMP MODULE	1
7	347499	HIGH PRESSURE MODULE BRACKET	1
8	NA	SOCKET HEAD CAP SCREW. M6 x 1.0 x 16 LG, SST	4
9	347489 347500	A SIDE HIGH PRESSURE MODULE B SIDE HIGH PRESSURE MODULE	1
10	NA	SOCKET HEAD CAP SCREW, M6 x 1.0 x 30 LG, SST	2
11	347480	PUMP I/O MODULE-CIRCUIT BOARD (DISTRIBUTOR ONLY)	1
12	347501 347502	A SIDE PUMP MODULE FRAME (INCL. 16) B SIDE PUMP MODULE FRAME (INCL. 16)	1
13	NA	SOCKET HEAD CAP SCREW, M6 x 1.0 x 8 LG, FLANGE, BO	2
14	NA	SOCKET HEAD CAP SCREW. M8 x 1.25 x 12 LG, FLANGE. BO	2
15	NA	SOCKET HEAD CAP SCREW, M8 x 1.25 x 12 LG, FLANGE. BO	4
16	347503	CAPTIVE SCREW. M10 x 1.5 x 40 mm, SST	1
17	347593 347664	HANDLE KIT, RED RECIRCULATION A VALVE HANDLE KIT, BLUE RECIRCULATION B VALVE	1

LOW PRESSURE MODULE

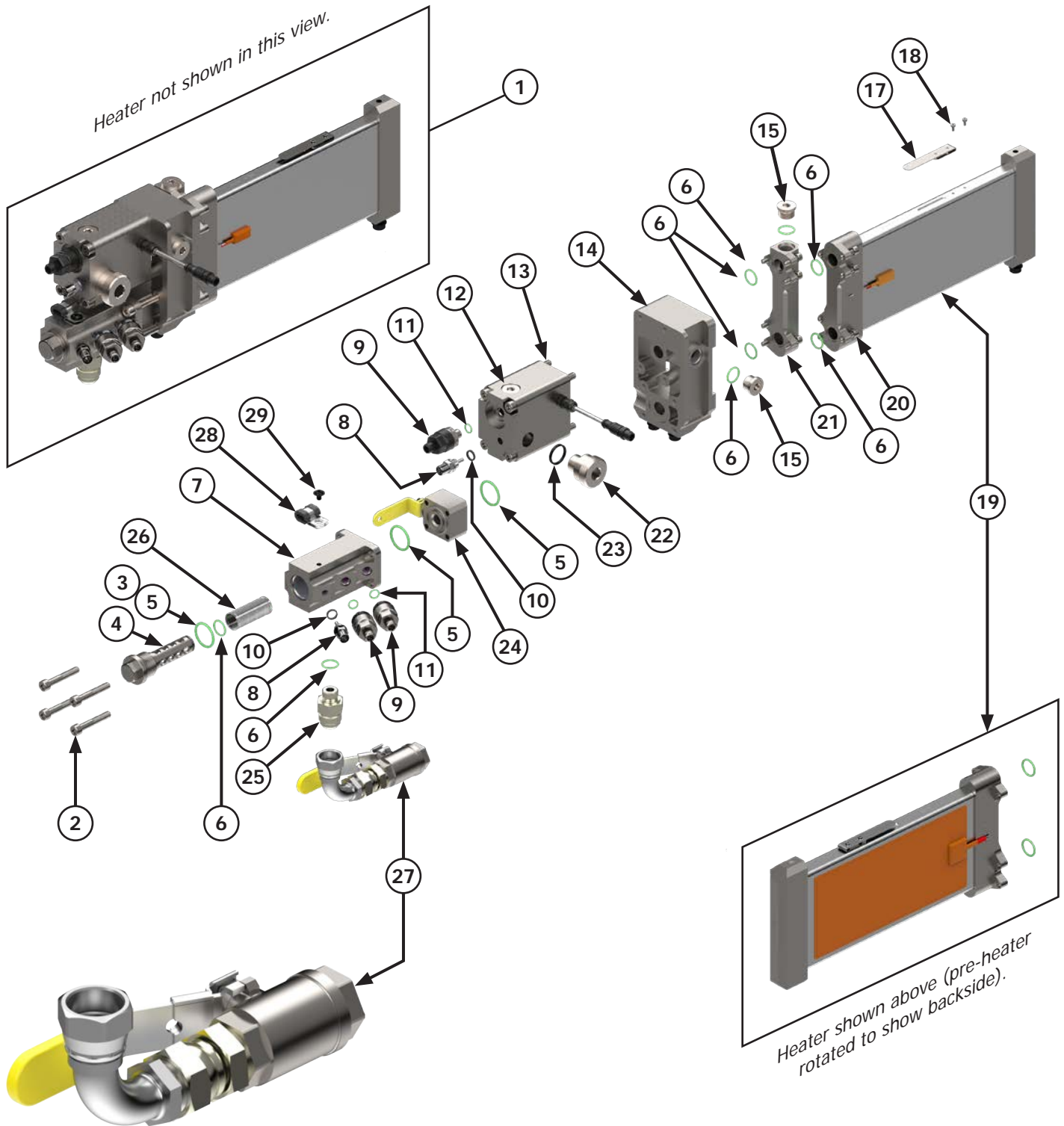

**Note:** Installation kit PN 341133 includes 90 degree sweeps (x2), ball valves (x2), and JIC to NPT fittings for recirculation line fittings on high pressure manifolds.

LOW PRESSURE MODULE			
Item	P/N	Description	Qty Used (Per Module)
1	347496	LOW PRESSURE MODULE POPULATED	1
2	NA	SOCKET HEAD CAP SCREW, M8 x 1.25 x 50 LG, SST	4
3	347466	FILTER O-RING KIT (INCL. 5, 6) 10 PK	1
4	347468	FILTER BODY KIT (INCL. 4, 5, 6, 26)	1
5	347508	O-RING, FILTER, BALL VALVE (3 PK)	3
6	347505	O-RING, INLET FITTING, FILTER MODULE, FLOWMETER, PREHEATER, BURST DISK, CHECK VALVE, RECIRCULATION VALVE. (8 PK)	16
7	347509	MANIFOLD, FILTER	1
8	347477	SENSOR, TEMP (INCL. 10)	2
9	347476	SENSOR, PRESSURE 0-1000 PSI (INCL. 11)	3
10	347506	SEAL, TEMPERATURE SENSOR (2 PK)	2
11	347507	O-RING, PRESSURE SENSOR (4 PK)	4
12	347460	FLOW METER (1 EA. 6, 10, 11, 23)	1
13	NA	SOCKET HEAD CAP SCREW, M8 x 1.25 x 100 LG	4
14	347567	MANIFOLD, PREHEATER	1
15	347568	PLUG (INCL. 6)	2
16	347569	THERMAL FUSE (NOT SHOWN)	1
17	NA	BRACKET, THERMAL FUSE	1
18	NA	SOCKET HEAD CAP SCREW, M3 x 0.5 x 6 LG, SST	2
19	347472	ASSEMBLY, PREHEATER (INCL. 6 x2, 20 x6, 17, 18 x2)	1
20	NA	SOCKET HEAD CAP SCREW, M6 x 1.0 x 20 LG, SST	6
21	347471	MANIFOLD, PREHEAT CAP (INCL. 6 x2, 15, 20 x6)	1
22	347510	FITTING, UNION, FLAT (INCL. 23)	2
23	347566	SEAL, UNION NIPPLE (3 PK)	3
24	347474	ASSY, BALL VALVE (INCL. 5 x2)	1
25	347504	FITTING, INLET (INCL. 6)	1
26	347464	FILTER ELEMENT, 30 MESH (10 PK)	1
	347465	FILTER ELEMENT, 30 MESH (50 PK)	
27	341133	INSTALLATION KIT	1

PUMP MODULE

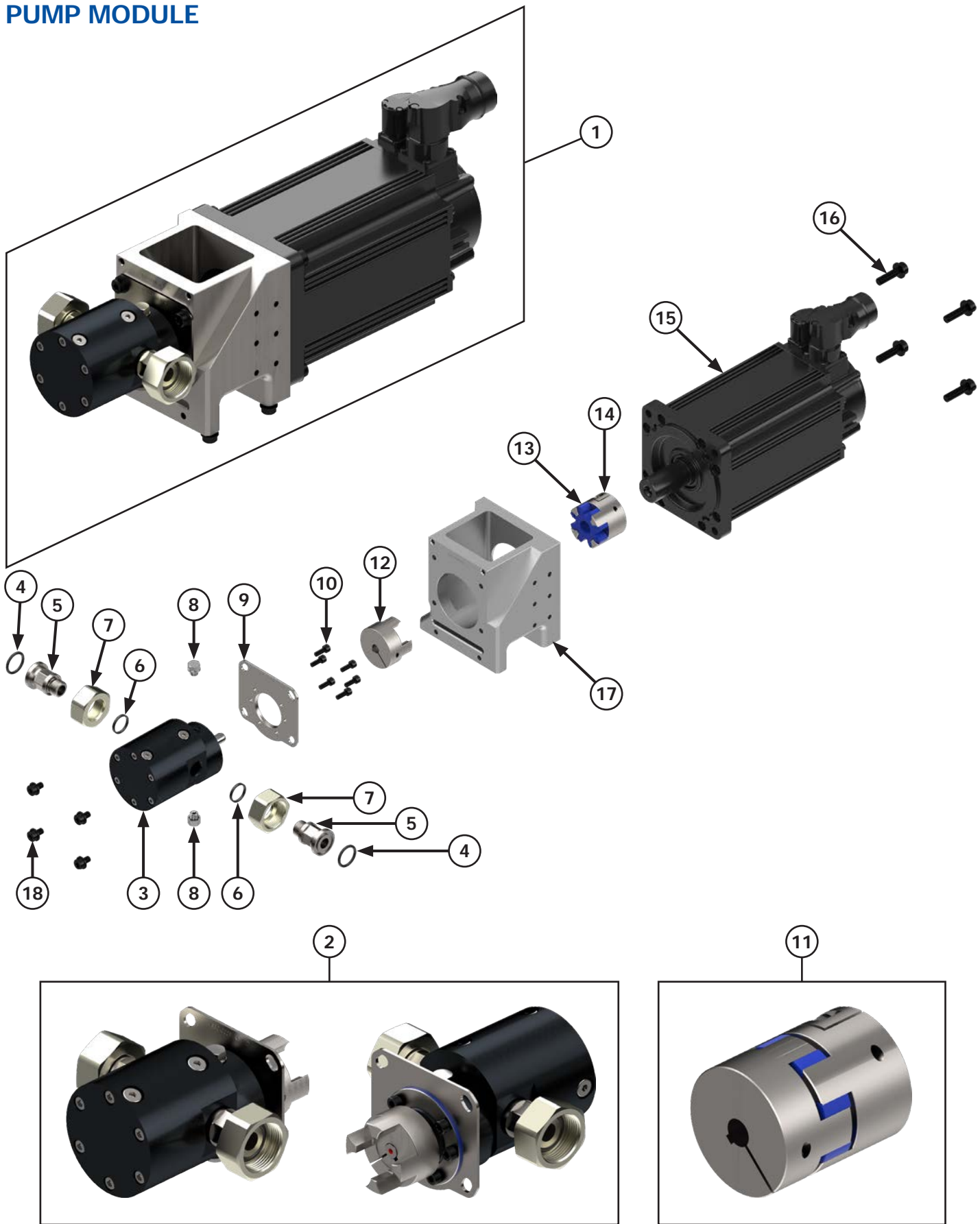



PUMP MODULE			
Item	P/N	Description	Qty Used (Per Module)
1	347498	PUMP MODULE	1
2	347486	ASSEMBLY, PUMP (INCL. 3-11)	1
3	347570	PUMP, GEAR (INCL. 8 x2, 7)	1
4	347572	O-RING, PUMP UNIONS (2 PK)	2
5	347573	FITTING, UNION, GROOVED (INCL. 4 x1, 6 x2)	2
6	347566	SEAL, UNION NIPPLE (3 PK)	3
7	347574	NUT, UNION	2
8	347571	PLUG, TSL CHAMBER, LOWER OR UPPER	2
9	347575	PLATE, PUMP MOUNT	1
10	NA	SOCKET HEAD CAP SCREW, M6 x 1.0 x 16 LG, SST	6
11	341040	ASSEMBLY, COUPLER (INCL. 12, 13, 14)	1
12	NA	SHAFT COUPLER, PUMP	1
13	NA	SHAFT COUPLER, SPIDER	1
14	NA	SHAFT COUPLER, MOTOR	1
15	341034	SERVO MOTOR (INCL. 16 x4)	1
16	NA	SOCKET HEAD CAP SCREW, M10 x 1.5 x 35 LG, FLANGE, BO	4
17	347576	MOUNTING BLOCK, PUMP AND MOTOR	1
18	NA	SOCKET HEAD CAP SCREW, M8 x 1.25 x 12 LG, FLANGE, BO	4

HIGH PRESSURE MODULE

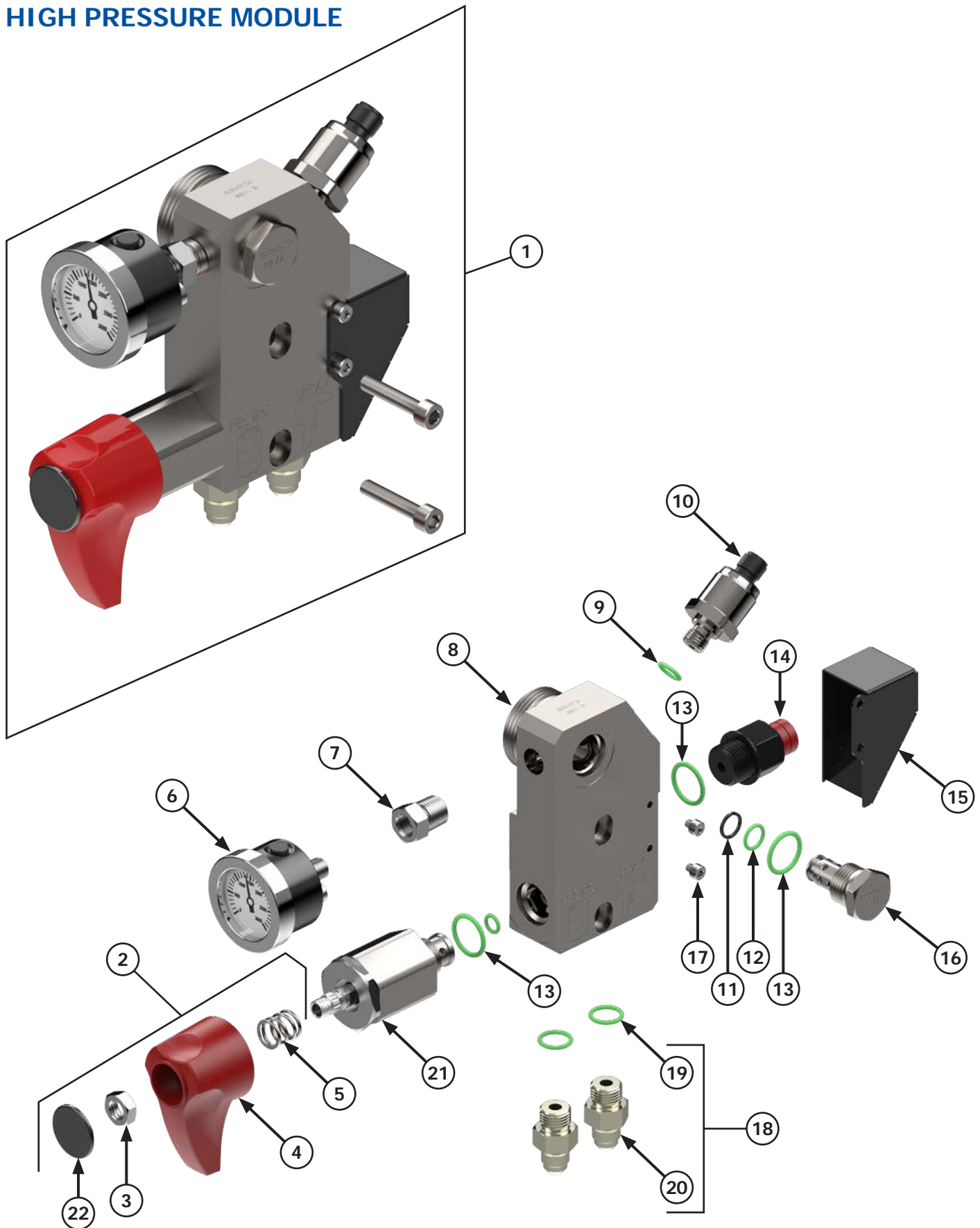

HIGH PRESSURE MODULE			
Item	P/N	Description	Qty Used (Per Module)
1	347489 347500	A SIDE HIGH PRESSURE MODULE B SIDE HIGH PRESSURE MODULE	1
2	347593 347664	HANDLE KIT, RED RECIRCULATION A VALVE (INCL. 3, 4, 5, 22) HANDLE KIT, BLUE RECIRCULATION B VALVE (INCL. 3, 4, 5, 22)	1
3	347592	NUT, RECIRCULATION VALVE	1
4	NA	HANDLE, RED RECIRCULATION VALVE (A SIDE) HANDLE, BLUE RECIRCULATION VALVE (B SIDE)	1
5	347590	SPRING, RECIRCULATION VALVE	1
6	347581	GAUGE, PRESSURE 0-3000 PSI	1
7	347582	BUSHING	1
8	347579	MANIFOLD, HIGH PRESSURE	1
9	347507	O-RING, PRESSURE SENSOR (4 PK)	4
10	347583	SENSOR, PRESSURE 0-5000 PSI (INCL. ITEM 9 x1)	1
11	347587	SPACER, CHECK VALVE NOSE (1 PK)	1
12	347586	O-RING, CHECK VALVE NOSE (1 PK)	1
13	347505	O-RING, INLET FITTING, FILTER MODULE, FLOWMETER, PREHEATER, BURST DISK, CHECK VALVE, RECIRCULATION VALVE. (8 PK)	1
14	347584	BURST DISK (INCL. 13)	1
15	347585	COVER, BURST DISK	1
16	347457	KIT, CHECK VALVE (INCL. 11, 12, 13)	1
17	NA	SOCKET HEAD CAP SCREW, M4 x 0.7 x 4 LG, SST	2
18	347589 347663	JIC 5 MALE TO 3/8 NPT MALE, A SIDE (INCL. 19) JIC 6 MALE TO 3/8 NPT MALE, B SIDE (INCL. 19)	2
19	347588	O-RING, HOSE AND RECIRCULATION JICS (2 PK)	2
20	NA	JIC 5 MALE TO 3/8 NPT MALE, A SIDE JIC 6 MALE TO 3/8 NPT MALE, B SIDE	2
21	347580	VALVE, RECIRCULATION (INCL. 13)	1
22	NA	CAP, RECIRCULATION HANDLE	1
23	341038 341039	KIT, VALVE RECIRCULATION ASSEMBLY, RED KIT, VALVE RECIRCULATION ASSEMBLY, BLUE	1
24	341041	KIT, RECIRCULATION VALVE, O-RING	1

PUMP I/O MODULE

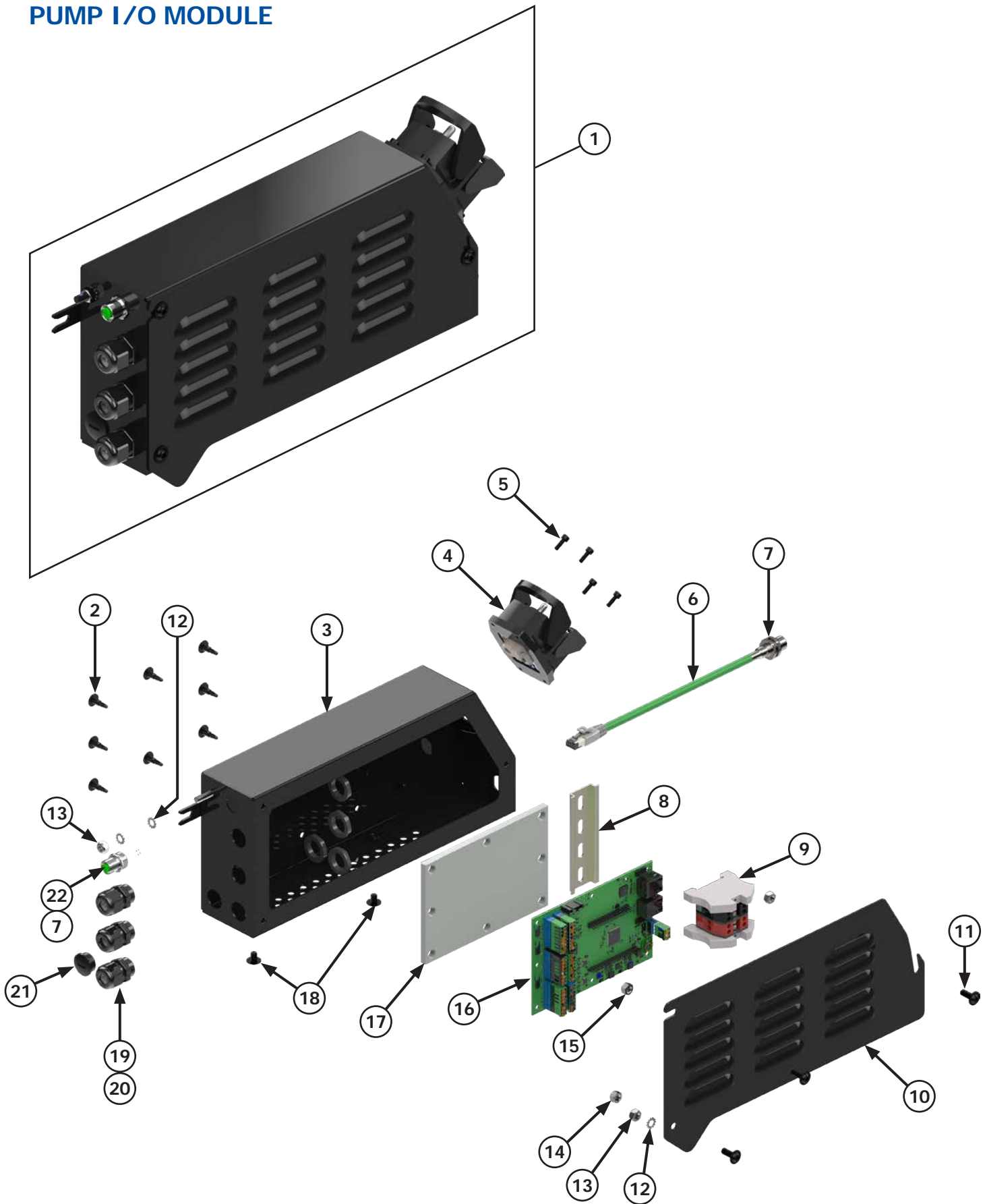

PUMP I/O MODULE			
Item	P/N	Description	Qty Used (Per Module)
1	347480	PUMP I/O MODULE-CIRCUIT BOARD (DISTRIBUTOR ONLY)	1
2	NA	STANDOFF, KEYSTONE	8
3	NA	I/O ENCLOSURE, FLUID MODULE	1
4	NA	CONNECTOR, FLUID MODULE POWER	1
5	NA	SOCKET HEAD CAP SCREW, M4 x 0.7 x 16 LG, BO	4
6	SEE CABLES	CABLE, ENCODER	1
7	NA	CABLE NUT	2
8	NA	DIN RAIL	1
9	NA	TERMINAL BLOCK ASSY	1
10	347596	I/O COVER, FLUID MODULE	1
11	NA	BUTTON HEAD CAP SCREW, M6 x 1.0 x 16 LG, FLANGE, BO	3
12	NA	M6 WASHER, EXTERNAL TOOTH	3
13	NA	M6 NUT, HEX	3
14	NA	NUT, HEX, M6 x 1.0, NYLON INSERT	2
15	NA	NUT, HEX, M6 x 1.0, ZINC	2
16	347594	I/O BOARD, FLUID MODULE	1
17	NA	I/O BOARD SUPPORT	1
18	NA	SOCKET HEAD CAP SCREW, M6 x 1.0 x 8 LG, FLANGE, BO	2
19	NA	CABLE GLAND	3
20	NA	NUT, CABLE GLAND	3
21	NA	PLUG	1
22	NA	BULKHEAD CONNECTOR,	1

# FLUID MODULE O-RINGS AND SEALS

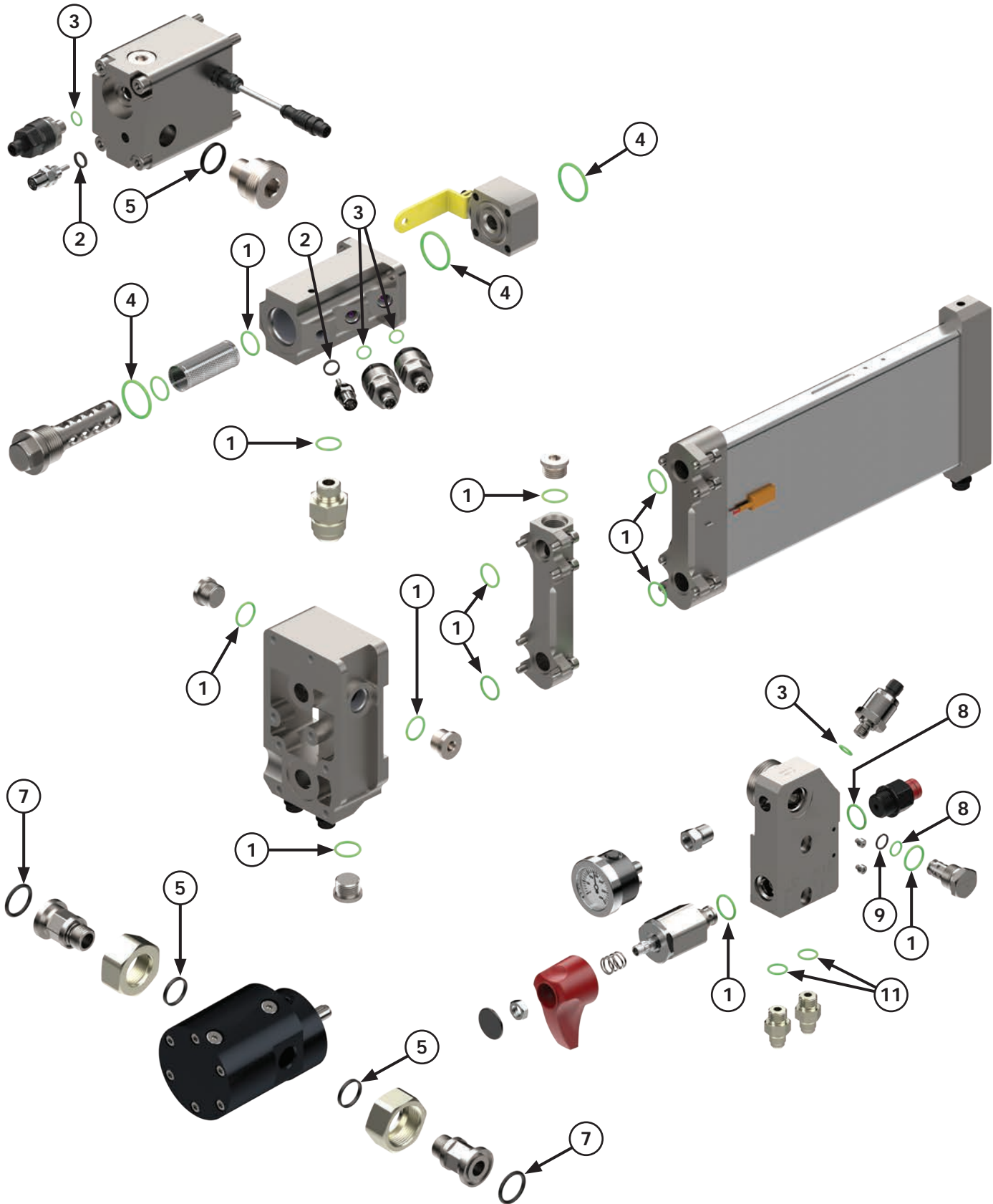



FLUID MODULE O-RINGS AND SEALS			
Item	P/N	Description	Qty Used (Per Module)
1	347505	O-RING, INLET FITTING, FILTER MODULE, FLOWMETER, PREHEATER, BURST DISK, CHECK VALVE, RECIRCULATION VALVE, (8 PK)	2
2	347506	SEAL, TEMPERATURE SENSOR (2 PK)	2
3	347507	O-RING, PRESSURE SENSOR (4 PK)	4
4	347508	O-RING, FILTER, BALL VALVE (3 PK)	3
5	347566	SEAL, UNION NIPPLE (3 PK)	3
6	347466	FILTER O-RING KIT (INCL 32, 39) 10 PK	1
7	347572	O-RING, PUMP UNIONS (2 PK)	2
8	347586	O-RING, CHECK VALVE NOSE (1 PK)	1
9	347587	SPACER, CHECK VALVE NOSE (1 PK)	1
10	347461	KIT (NOT SHOWN), IS30 O-RINGS AND SEALS (INCLUDES ALL ITEMS TO SERVICE ONE A OR B FLUID MODULE)	1
11	347588	O-RING, HOSE AND RECIRCULATION JICS (2 PK)	2

CONTROL MODULE  
ENCLOSURE

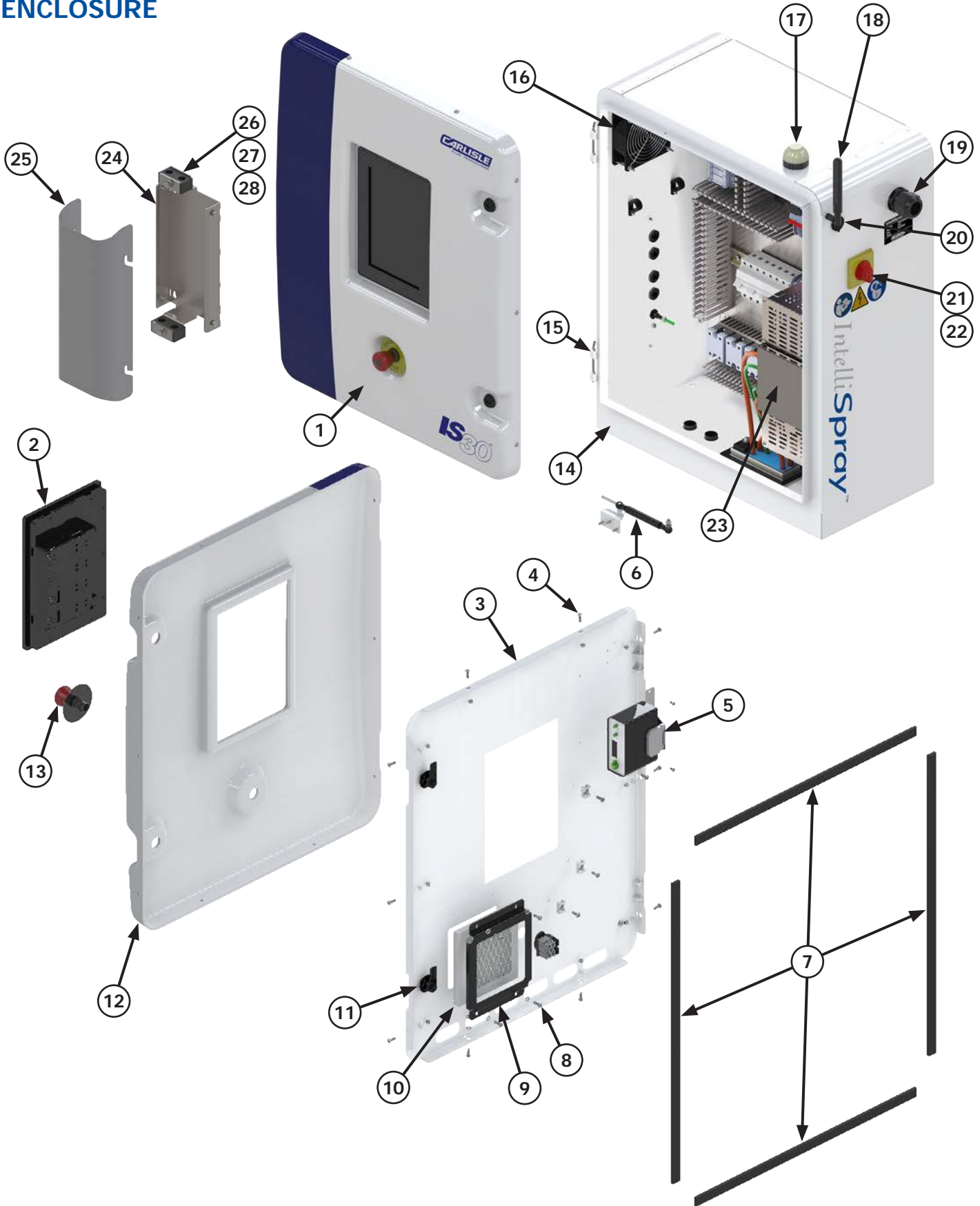

CONTROL MODULE ENCLOSURE			
Item	P/N	Description	Qty Used (Per Module)
1	NA	CONTROL MODULE COVER ASSEMBLY	1
2	347458	10" HMI WITH CODESYS	1
3	NA	CONTROL MODULE PLATE	1
4	NA	COVER SCREW	10
5	NA NA	CELLULAR MODEM (US, CA, MEX ONLY) CELLULAR MODEM (EU ONLY)	1
6	347607	COVER STRUT ASSEMBLY	1
7	NA	COVER GASKET	1
8	NA	AIR FILTER BRACKET SCREWS	4
9	NA	AIR FILTER BRACKET	1
10	347459	AIR FILTER	1
11	347606	COVER LOCK ASSEMBLY	2
12	347665	CONTROL MODULE COVER	1
13	347598	E-STOP KIT (INCL. CONTACTORS)	1
14	NA	CONTROL MODULE FRAME	1
15	347609	DOOR HINGE ASSY	2
16	347615	CONTROL MODULE FAN ASSY	1
17	347483	BEACON LIGHT	1
18	347613	CELLULAR ANTENNA	1
19	347612	POWER CORD GLAND	1
20	347611	USB KIT	1
21	347610 347689	POWER SWITCH ASSY (INCL 22) DISCONNECT KIT, 3PH+N, 600V, 80A (INCL 22)	1
22	347597	POWER SWITCH HANDLE	1
23	NA	EMI CAGE	1
24	NA	IS30 SMOSE CLAMP BRACKET	1
25	NA	IS30 SMOSE COVER	1
26	NA	IS30 SMOSE CLAMP TOP PLATE	2
27	NA	M10 FLANGE HEAD CAP SCREW	2
28	NA	SMOSE CLAMP BLOCK	4

### IS30 CONTROL MODULE CONTROL PANEL 200V-240V

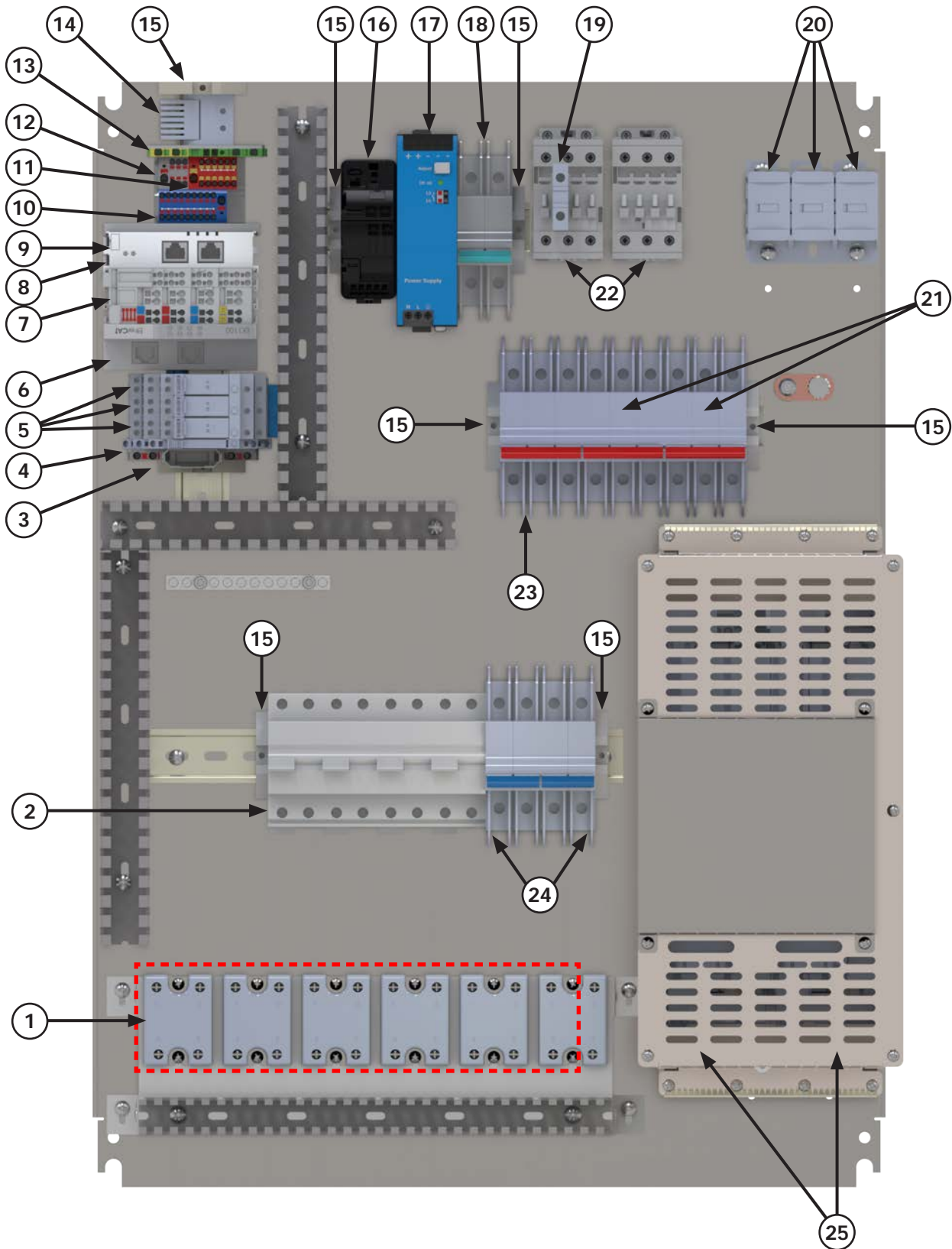

CONTROL MODULE 200V-240V CONTROL PANEL			
Item	P/N	Description	Qty Used (Per Module)
1	341015	HEATER SSRS	6
2	347631	HOSE HEAT GFCI 15A	4
3	347678	HOSE COMM RESET	1
4	347645	HOSE COMM RELAY	1
5	340993	TERMINAL BLOCK RELAY	3
6	341017	ECAT COUPLER	1
7	341020	ECAT DIGITAL INPUT 8CH	1
8	341021	ECAT DIGITAL OUTPUT 16CH	1
9	341018	ECAT JUNCTION 2CH	1
10	347603	DISTRIBUTION BLOCK, 4/18	1
11	347602	DISTRIBUTION BLOCK, 4/12	1
12	347601	DISTRIBUTION BLOCK, 4/6	1
13	347600	TERMINAL BLOCK GROUND AND BARRIER	1
14	340979	THERMOSTAT	1
15	NA	TERMINAL BLOCK END ANCHOR	5
16	347624	24V 4 CHANNEL ELECTRONIC CIRCUIT BREAKER	1
17	347623	24V POWER SUPPLY	1
18	347622	24V POWER SUPPLY CIRCUIT BREAKER 6A	1
19	347621	AUXILIARY CONTACT BLOCK	1
20	347619	POWER DISTRIBUTION BLOCK	3
21	347617	MOTOR DRIVE CIRCUIT BREAKER 13A	2
22	347620	MAINS CONTACTOR	2
23	347618	HEATER MAIN CIRCUIT BREAKER 60A	1
24	347630	PREHEATER CIRCUIT BREAKER 30A	2
25	341055	SERVO DRIVE, 18AMP, ECAT FIRMWARE	2
NA	347688	FERRITE 250OHM (NOT SHOWN)	1

IS30 CONTROL MODULE  
CONTROL PANEL 380V-415V

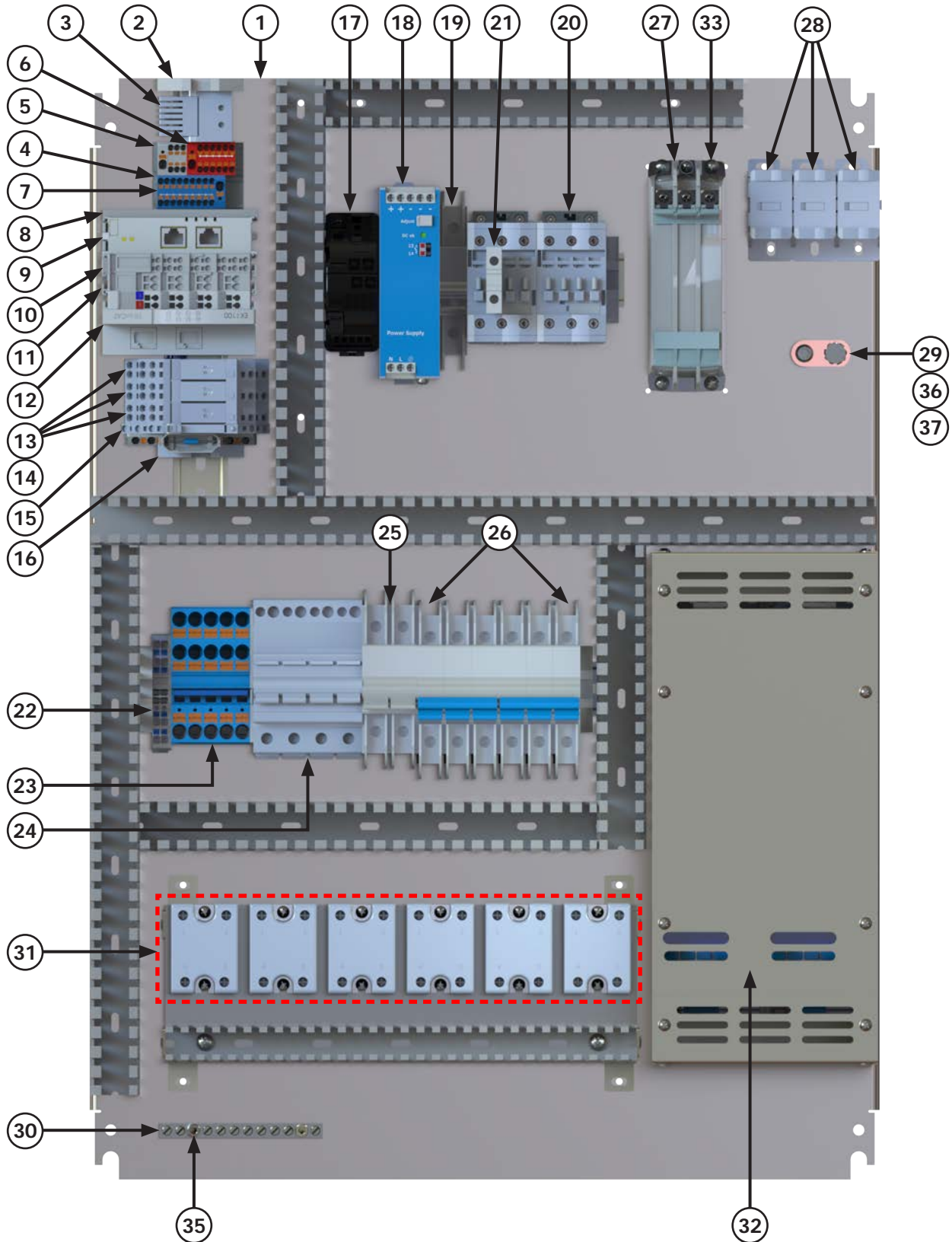



## CONTROL MODULE 380V-415V CONTROL PANEL

Item	P/N	Description	Qty Used (Per Module)
1	NA	IS30 EU BACK PANEL	1
2	NA	TERMINAL END BLOCK	5
3	340979	THERMOSTAT	1
4	NA	DIN RAIL ADAPTER 1049497	2
5	347601	DISTRIBUTION BLOCK 4/6	1
6	347602	DISTRIBUTION BLOCK 4/12	1
7	347603	DISTRIBUTION BLOCK 4/18	1
8	NA	BECKHOFF BUS END CAP	1
9	341018	ECAT JUNCTION 2CH	1
10	341021	ECAT DIGITAL OUTPUT 16CH	1
11	341020	ECAT DIGITAL INPUT 8CH	1
12	341017	ECAT COUPLER	1
13	340993	TERMINAL BLOCK RELAY	3
14	NA	TERMINAL BLOCK JUMPER, 8 POLE, BLUE	1
15	347645	HOSE COMM RELAY	1
16	347678	HOSE COMM RESET	1
17	347624	24V 4 CHANNEL ELECTRONIC CIRCUIT PROTECTION	1
18	347623	24V POWER SUPPLY	1
19	347679	CIRCUIT BREAKER, 6A, 1P	1
20	347620	MAIN CONTACTOR	2
21	347621	AUXILLIARY CONTACT BLOCK	1
22	347704	GOUND TERMINAL W/BARRIER	1
23	347681	NEUTRAL DISTRIBUTION BLOCK ASSEMBLY	1
24	347683	GFCI 16A 1P+N	4
25	347684	CIRCUIT BREAKER, 1P, 30A	2
26	347685	CIRCUIT BREAKER, 3P, 10A	2
27	347686	LINE FILTER, 30A	1
28	347619	POWER DISTRIBUTION BLOCK	3
29	NA	GROUND LUG 1/0-8AWG	1
30	NA	GROUND BAR	1
31	341015	HEATER SSRS	1
32	347687	SERVO DRIVE, 18AMP, 400V, ECAT FIRMWARE	1
33	NA	M4X.7 x 10 mm EW TRUSS PHIL SCREW	1
34	NA	M4 SPLIT WASHER, 18-8 SS	1
35	NA	SHCS, M5 x 20, 18-8	1

**CONTROL MODULE 380V-415V CONTROL PANEL (cont.)**

Item	P/N	Description	Qty (Per Module)
36	NA	M8 x 1.25 x 20 mm HEX BOLT	1
37	NA	M8 EXTERNAL TOOTH LOCKWASHER	1
38	347688	FERRITE 250OHM (NOT SHOWN)	4
39	NA	IS30 CE CAGE - ASSEMBLY	1
40	NA	VELCRO STRAP 1/2" BLK 330 (NOT SHOWN)	1

## CABLES-REFER TO WIRING DIAGRAMS FOR CBL NUMBER

CONTROL MODULE			
Cable No.	P/N	Description	Qty
CBL2007	347633	A-ISO ZONE 1 HOSE HEAT	1
CBL2010	347634	B-RES ZONE 1 HOSE HEAT	1
CBL2014	347635	B-RES ZONE 1 HOSE HEAT	1
CBL2017	347636	B-RES ZONE 2 HOSE HEAT	1
CBL3017	347637	HOSE MASTER MODEM POWER	1
CBL4004	347638	HOSE MASTER MODEM COMMUNICATION	1
CBL4208	NA	BEACON LIGHT (INCL IN 347483)	1
CBL4401	347640	A SIDE MASTER COMMUNICATION	1
CBL4404	347641	B SIDE MASTER COMMUNICATION	1
CBL5020	347642	HMI TO BUS COUPLER COMMUNICATION	1
CBL5505	347643	ANTENNA EXTENSION CABLE	1
CBL5514	347644	ROUTER TO HMI COMMUNICATION	1
CBL5517	NA	CELLULAR ROUTER (INCL WITH ITEM 207)	1
CBL6007	347646	A SIDE MOTOR ENCODER	1
CBL6017	347647	A SIDE MOTOR POWER	1
CBL6027	347648	A SIDE DRIVE TO PUMP COMMUNICATION	1
CBL7007	347649	B SIDE MOTOR ENCODER	1
CBL7017	347650	B SIDE MOTOR POWER	1
CBL7027	347651	B SIDE DRIVE TO PUMP COMMUNICATION	1
CBL9003	347652	PUMP MODULE COMMUNICATION	2
CBL9010	347569	THERMO-OVERLOAD	2
CBL9506	347655	ENCODER BULKHEAD	2
CBL9609	NA	HEATER TEMP SENSOR (INCL. WITH 347472)	2
CBL9614	347657	INLET FLUID TEMP	2
CBL9619	347658	PRE-HEATER OUT TEMP	2
CBL9704	347659	PRE-FILTER PRESSURE	2
CBL9709	347660	POST-FILTER PRESSURE	2
CBL9714	347661	PRE-GEAR PUMP PRESSURE	2
CBL9719	347662	POST-GEAR PUMP PRESSURE	2

## ELECTRICAL DIAGRAMS

**WIRE GAUGE (UNLESS NOTED) USE MIN 75 DEGREE C COPPER WIRE**

American Wire Gauge AWG	Diameter (Inches)	Cross Sectional Area (mm <sup>2</sup> )	Ampacity (75° C Copper)
3	0.2292	26.65	100
4	0.2043	21.14	85
6	0.162	13.29	65
8	0.1285	8.36	52
10	0.1019	5.26	30
12	0.0808	3.31	20
14	0.0641	2.08	15
16	0.0508	1.31	10
18	0.0403	0.82	7
20	0.0320	0.52	5
22	0.0253	0.33	3

**FERRULES TO BE USED ON ALL WIRES (UNLESS NOTED)**

Wire Reference	Description
BLACK	UNGROUND LINE VOLTAGE
WHITE	UNGROUND DC VOLTAGE
WHITE/BLUE	GROUND DC COMMON
GREEN/YELLOW	GROUND

WIRE REFERENCE	COLOR
BLK	Black
WHT	White
BLU	Blue
RED	Red
GRN	Green
ORG	Orange
BRN	Brown
YLW	Yellow

WIRE REFERENCE	COLOR
RED_GRY	RED w/GREY STRIPE
GRY_RED	GREY w/WHITE STRIPE
WHT_BRN	WHITE w/BROWN STRIPE
BRN_WHT	BROWN w/WHITE STRIPE
WHT_GRY	WHITE w/GREY STRIPE
GRY_WHT	GREY w/WHITE STRIPE
RED_BLU	RED w/BLUE STRIPE
BLU/RED	BLUE w/RED STRIPE
RED/ORG	RED w/ORANGE STRIPE
ORG/RED	ORANGE w/RED STRIPE
RED/GRN	RED w/GREEN STRIPE
GRN_RED	GREEN w/RED STRIPE
BRN_RED	BROWN w/RED STRIPE
RED_BRN	RED w/BROWN STRIPE
WHT_GRN	WHITE w/GREEN STRIPE
GRN_WHT	GREEN w/WHITE STRIPE
WHT_BLU	WHITE w/BLUE STRIPE
BLU_WHT	BLUE w/WHITE STRIPE
WHT_ORG	WHITE w/ORANGE STRIPE
ORG_WHT	ORANGE w/WHITE STRIPE

LEGEND DESCRIPTIONS  
 NUMBERING CODE  
 XX???? = COMPONENT TYPE  
 ??XX?? = SHEET  
 ?????XX = COLUMN

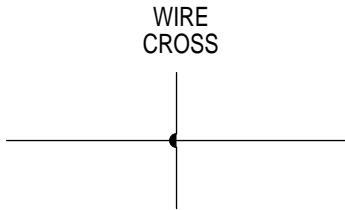

CABLE NUMBER  
 CORE IDENTIFIER

CBL????/COLOR

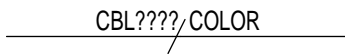

TERMINAL BLOCK  
 WIRE NUMBER



PUSHBUTTON  
 NORMALLY OPEN

PB????

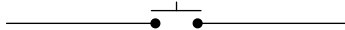

PUSHBUTTON  
 NORMALLY CLOSED

PB????

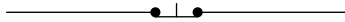

FUSE WITH  
 RATING

FU????



FUSED DISCONNECT  
 WITH RATING

DS????  
 ??A

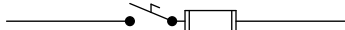

NORMALLY OPEN  
 SELECTOR SWITCH

SS????  
 OX

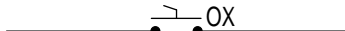

WIRE  
 CONNECTION

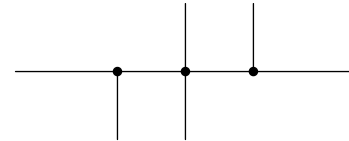

CIRCUIT BREAKER  
 WITH RATING

CB????



CONTROL  
 RELAY COIL

CR????

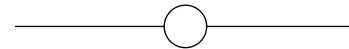

CONTROL RELAY  
 NORMALLY OPEN  
 CONTACT

CR????

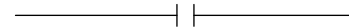

CONTROL RELAY  
 NORMALLY CLOSED  
 CONTACT

CR????

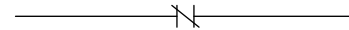

SOLENOID

SOL????



NORMALLY CLOSED  
 LIMIT SWITCH

LS????



NORMALLY OPEN  
 PRESSURE SWITCH

PS????

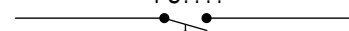



DRAWING 2

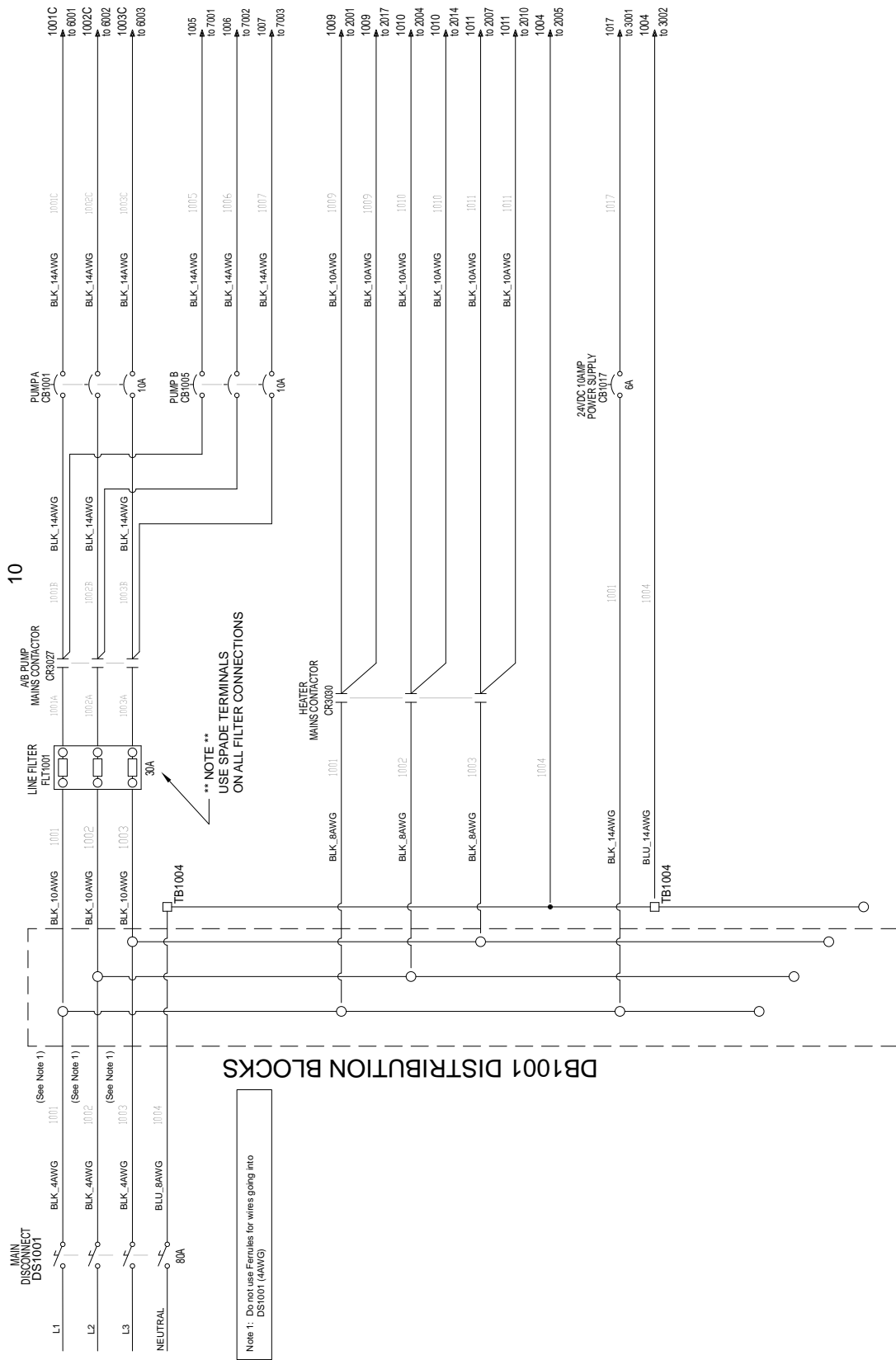

NOTE:  
CUSTOMER SUPPLIED  
400VAC, 60AMP, 3PH, 60HZ  
USE 75 DEGREE COPPER WIRE ONLY

DRAWING 3

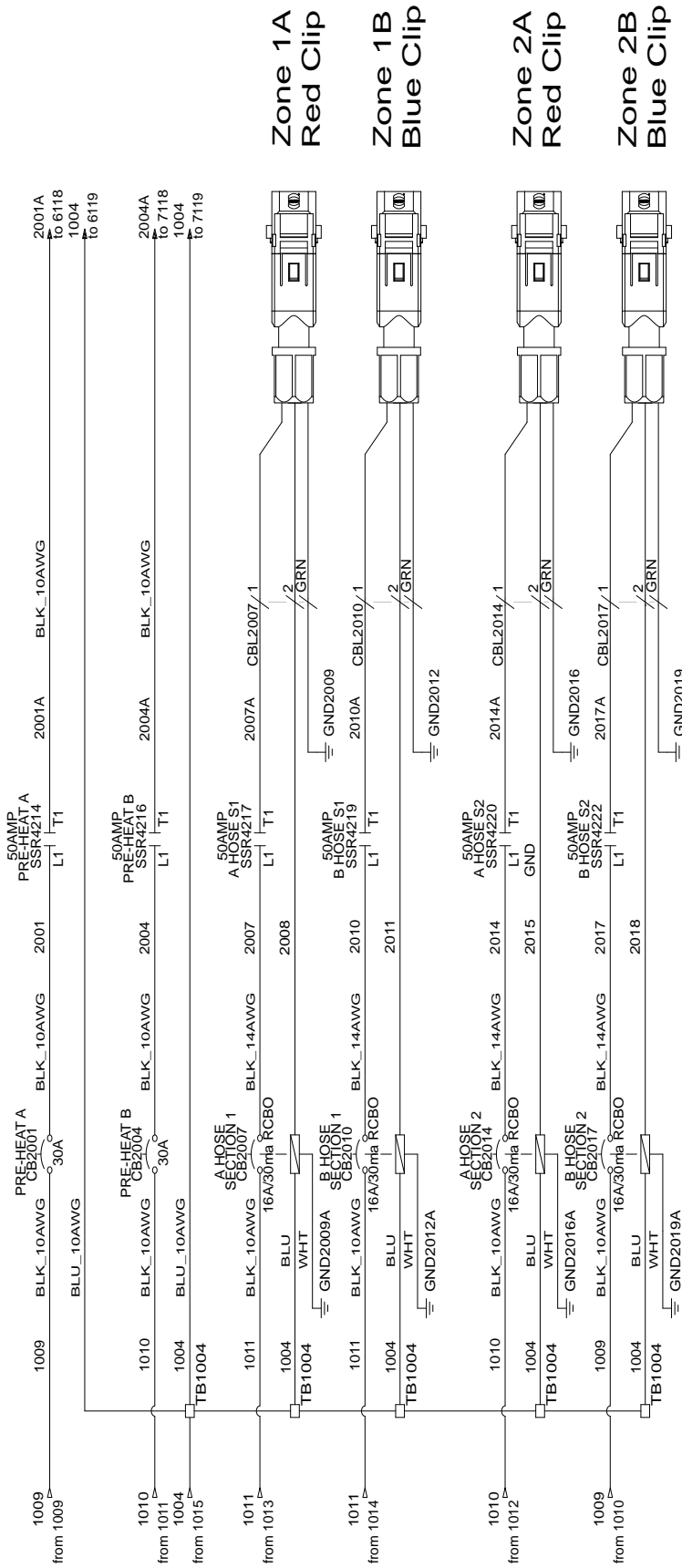



DRAWING 5

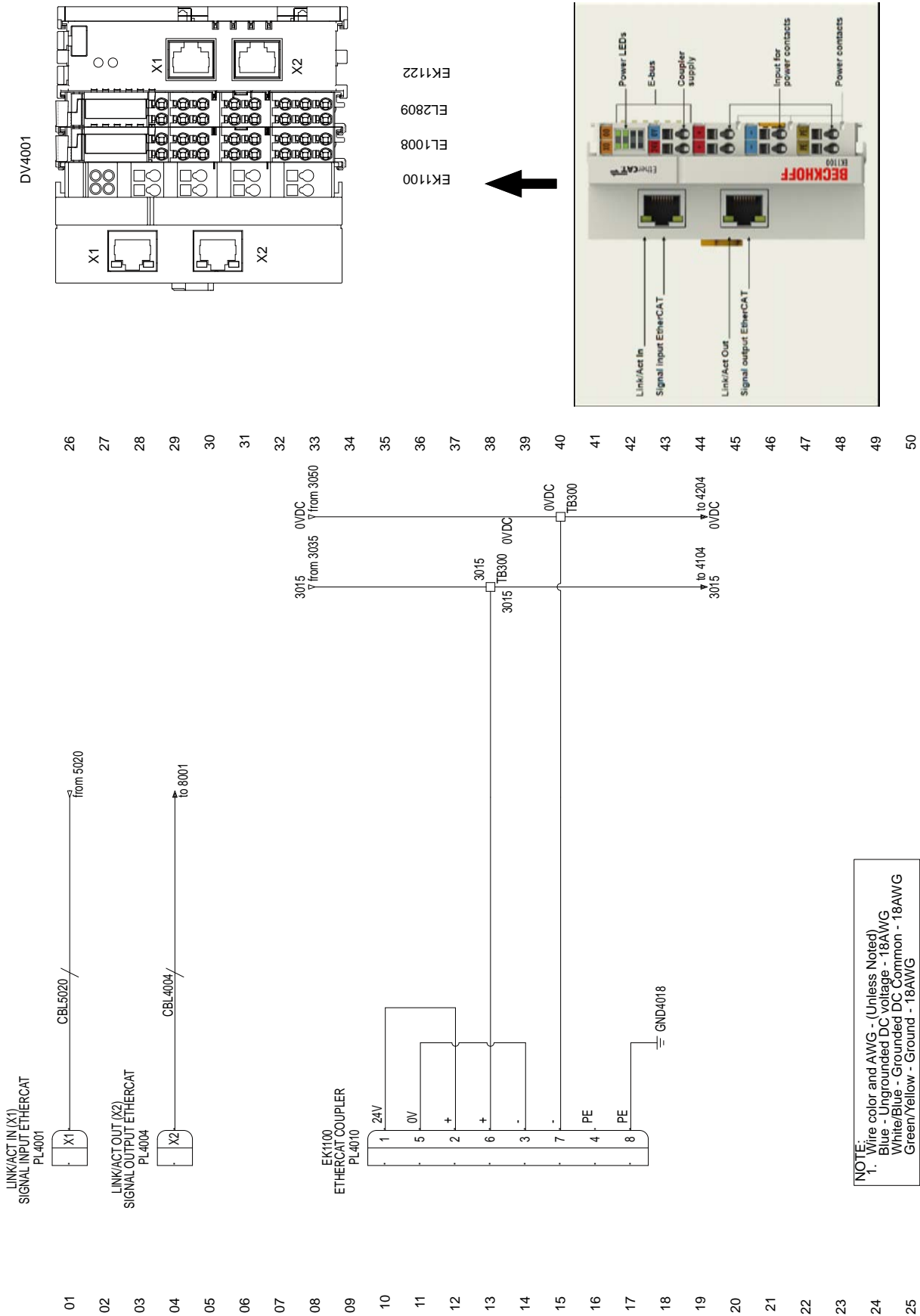

DRAWING 6



EK1122  
EL2809  
EL1008  
EK1100

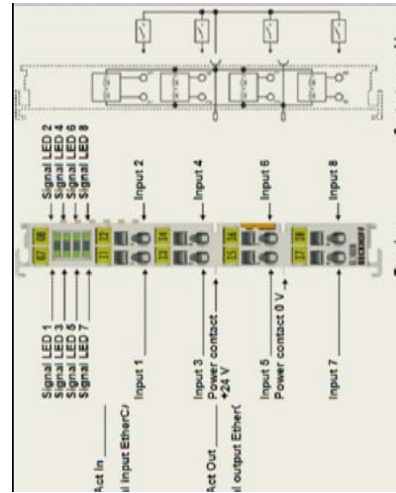

26  
27  
28  
29  
30  
31  
32  
33  
34  
35  
36  
37  
38  
39  
40  
41  
42  
43  
44  
45  
46  
47  
48  
49  
50

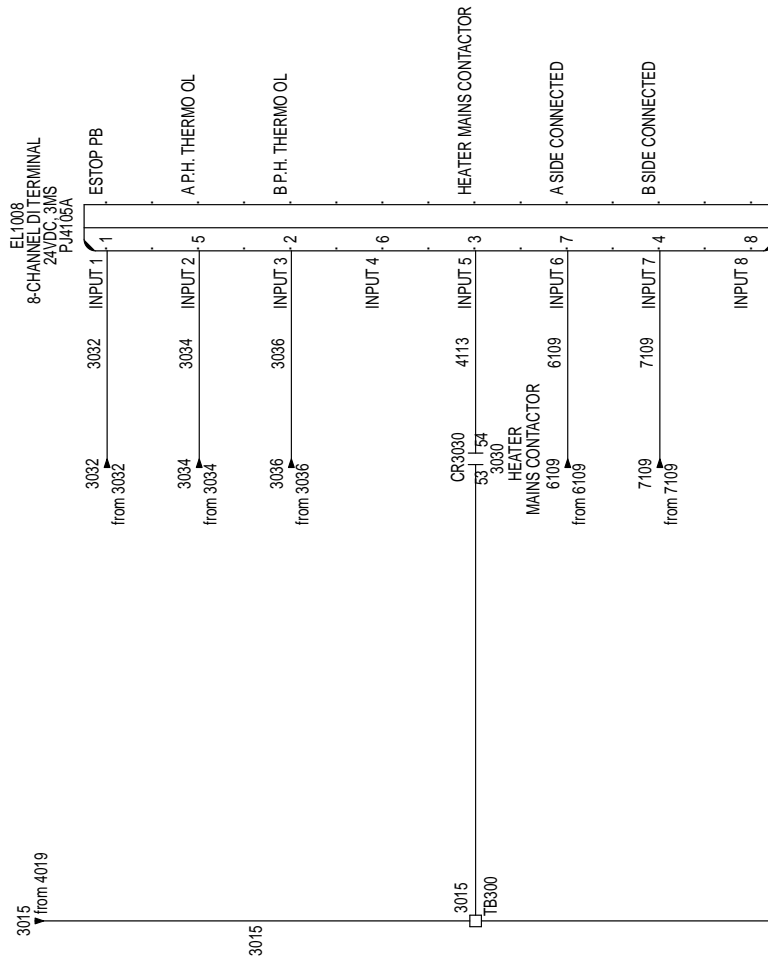

**NOTE:**  
1. Wire color and AWG - (Unless Noted)  
Blue - Ungrounded DC voltage - 18AWG  
White/Blue - Grounded DC, Common - 18AWG  
Green/Yellow - Ground - 18AWG

01  
02  
03  
04  
05  
06  
07  
08  
09  
10  
11  
12  
13  
14  
15  
16  
17  
18  
19  
20  
21  
22  
23  
24  
25

DRAWING 7

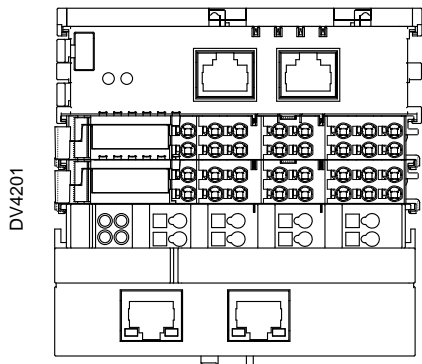

EK1122  
EL2809  
EL1008  
EK1100

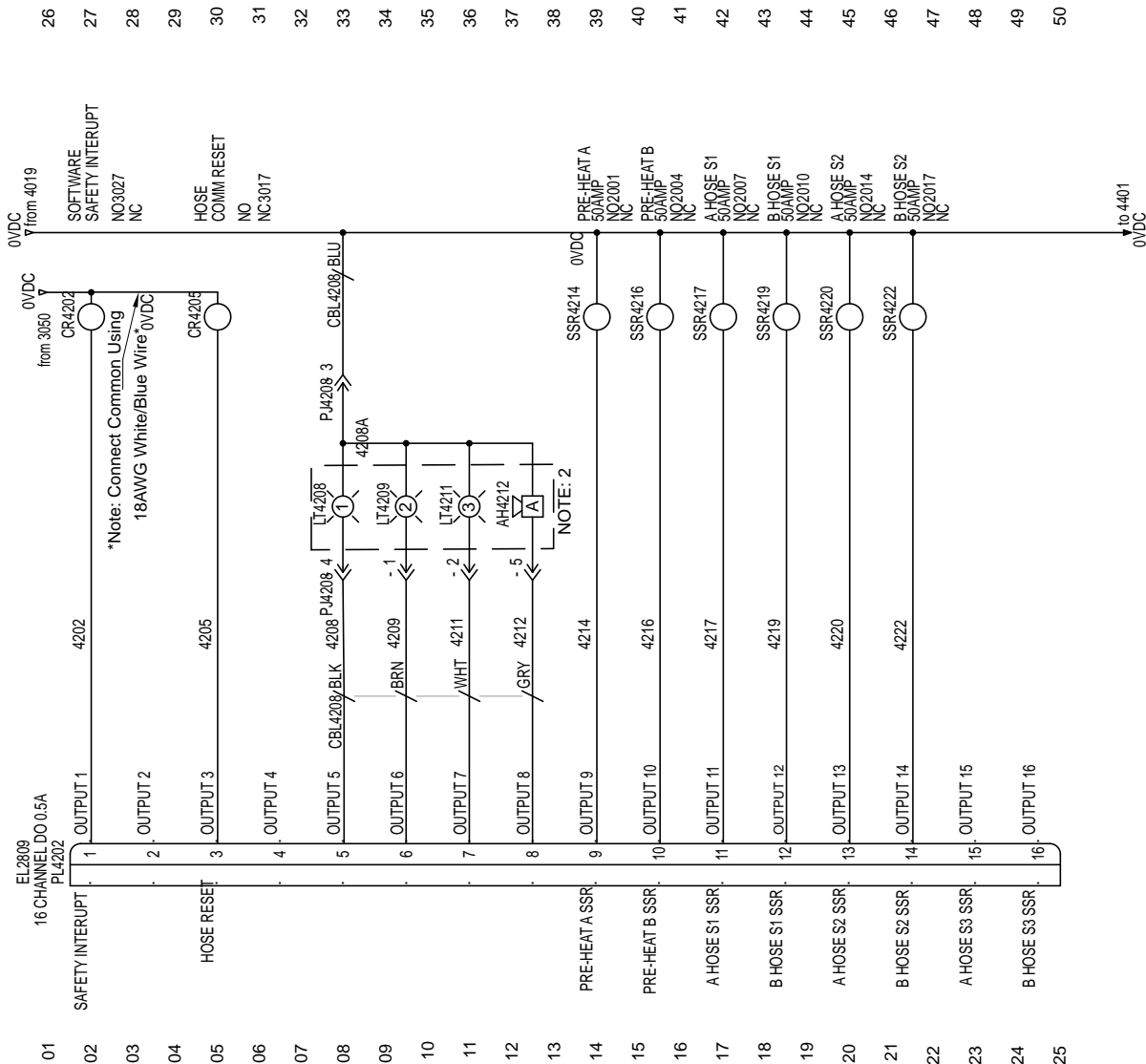
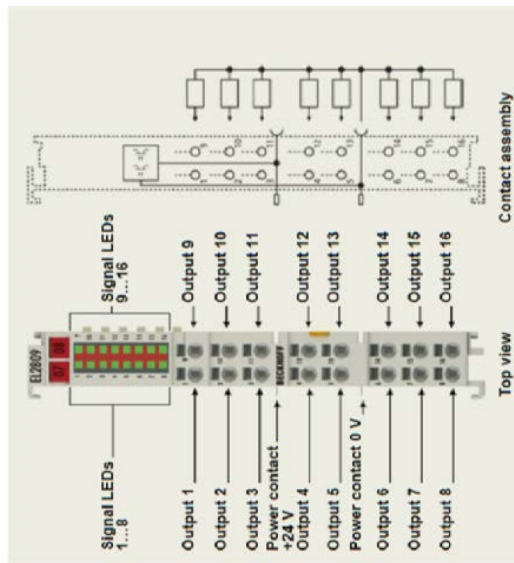

NOTE: 2 Color Chart  
1. Wire color and AWG - (Unless Noted)  
Blue - Ungrounded DC voltage - 18AWG  
White/Blue - Grounded DC Common - 18AWG  
Green/Yellow - Ground - 18AWG



DRAWING 8

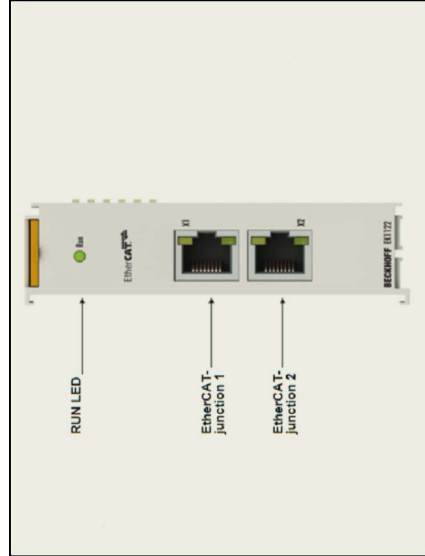
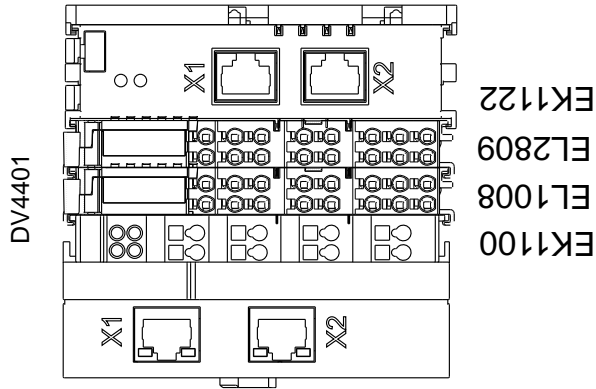

26  
27  
28  
29  
30  
31  
32  
33  
34  
35  
36  
37  
38  
39  
40  
41  
42  
43  
44  
45  
46  
47  
48  
49  
50

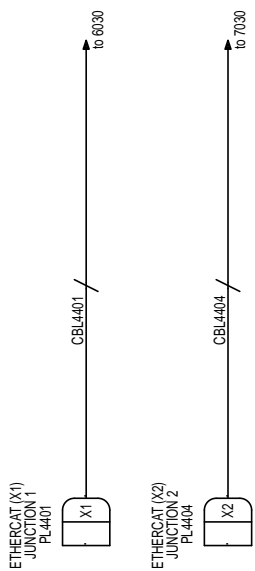

NOTE:  
Wire color and AWG - (Unless Noted)  
1. Blue - Un-grounded DC voltage - 18AWG  
White/Blue - Grounded DC Common - 18AWG  
Green/Yellow - Ground - 18AWG

DRAWING 9

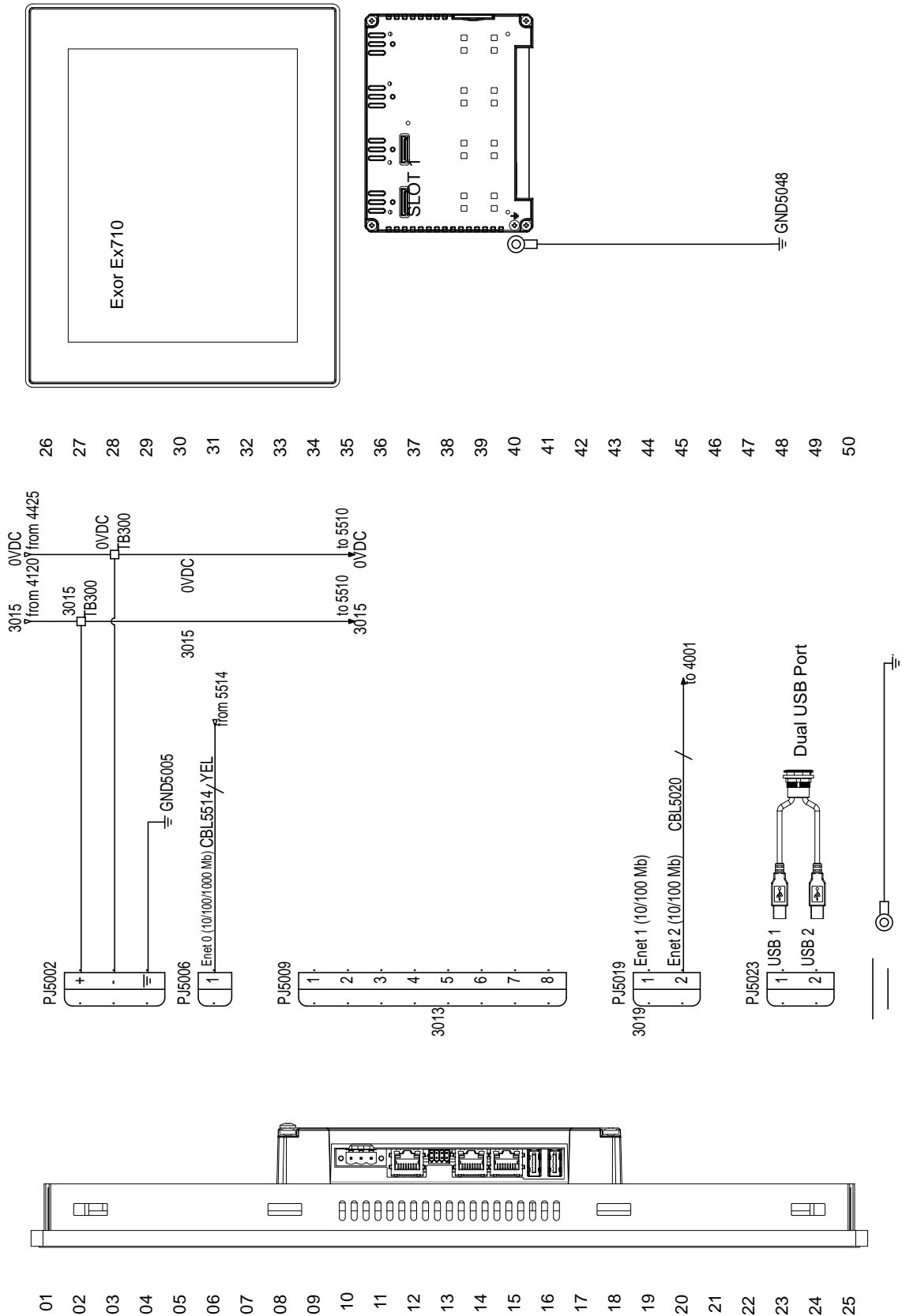

DRAWING 10

Remote Connectivity Kit Part# IS30-0149

DV5501

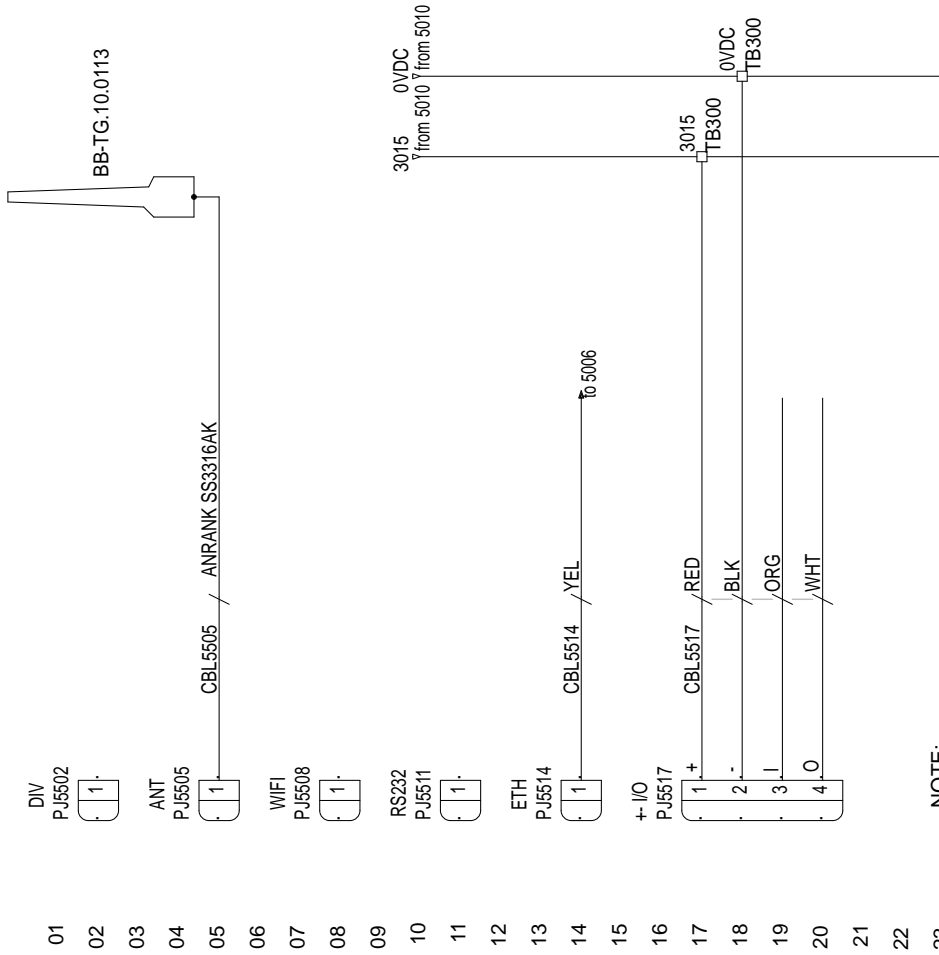

NOTE:

- 1. Wire color and AWG - (Unless Noted)
- Blue - Ungrounded DC voltage - 18AWG
- White/Blue - Grounded DC Common - 18AWG
- Green/Yellow - Ground - 18AWG

DRAWING 11

Remote Connectivity Kit Part# IS30-0173

DV5501

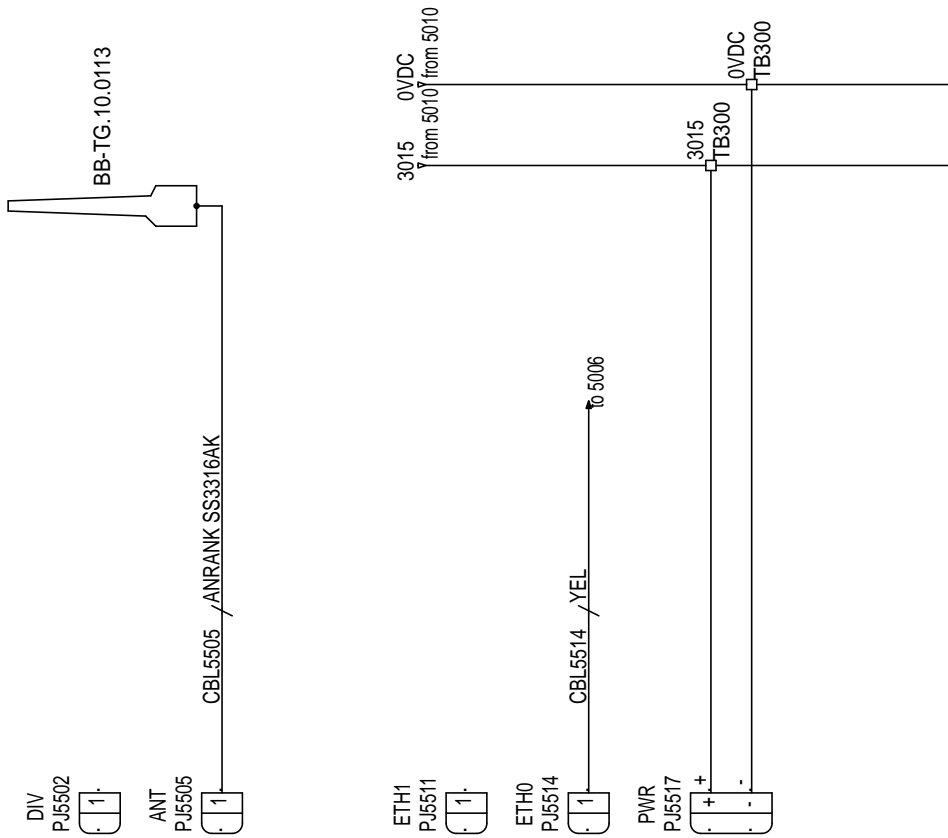
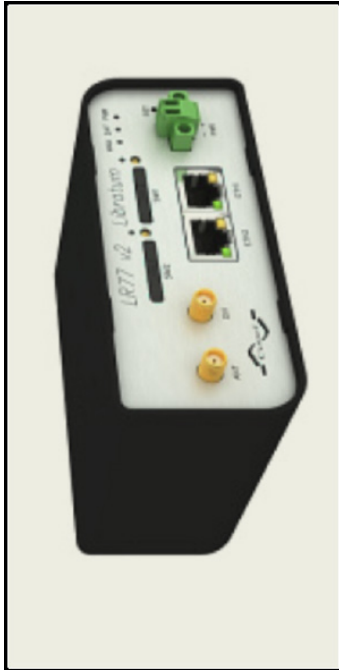

- 01
- 02
- 03
- 04
- 05
- 06
- 07
- 08
- 09
- 10
- 11
- 12
- 13
- 14
- 15
- 16
- 17
- 18
- 19
- 20
- 21
- 22
- 23
- 24
- 25

DRAWING 12

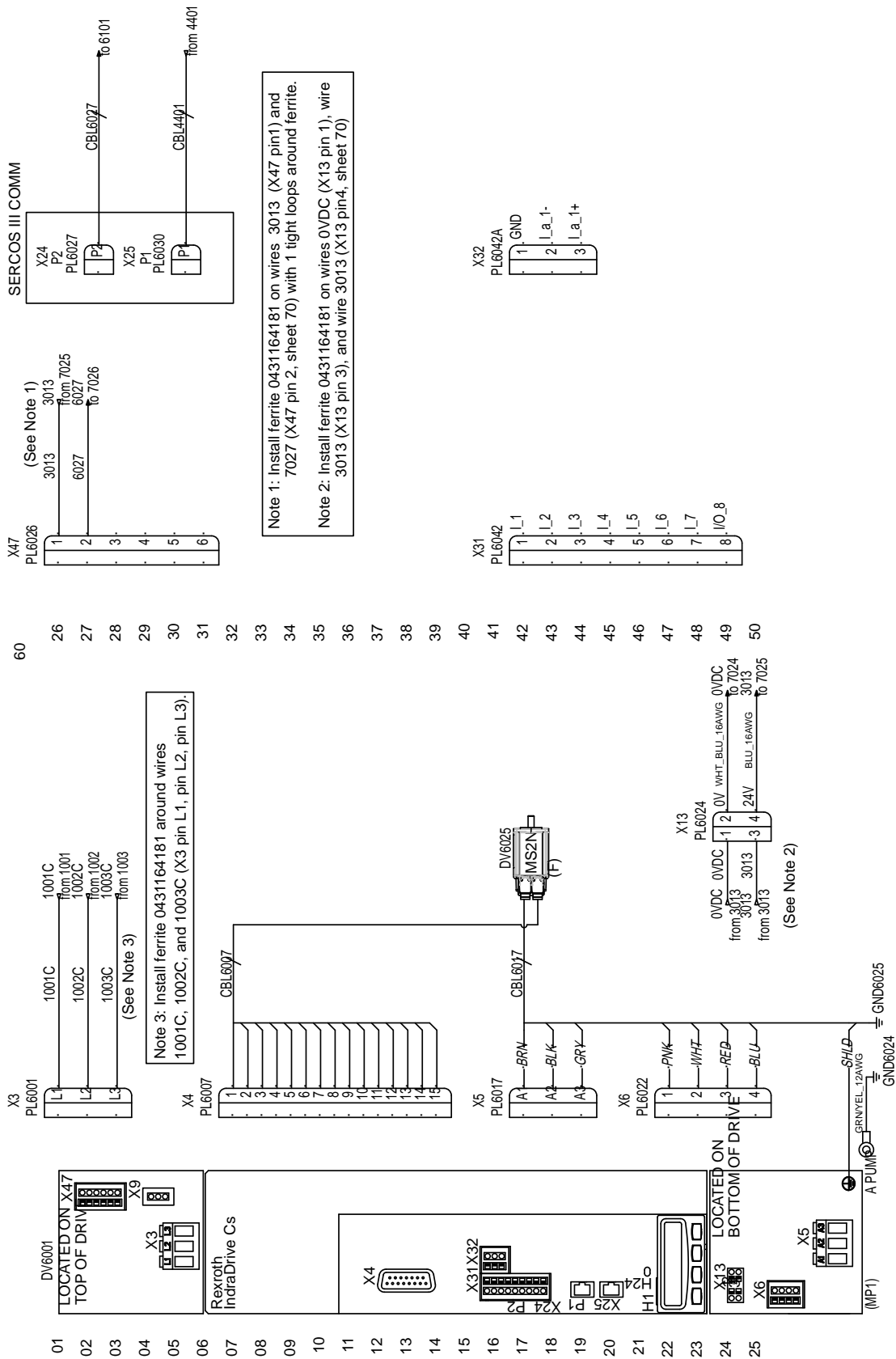

DRAWING 13

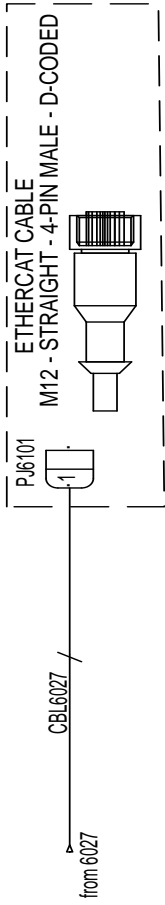

OPTION LENGTHS AVAILABLE

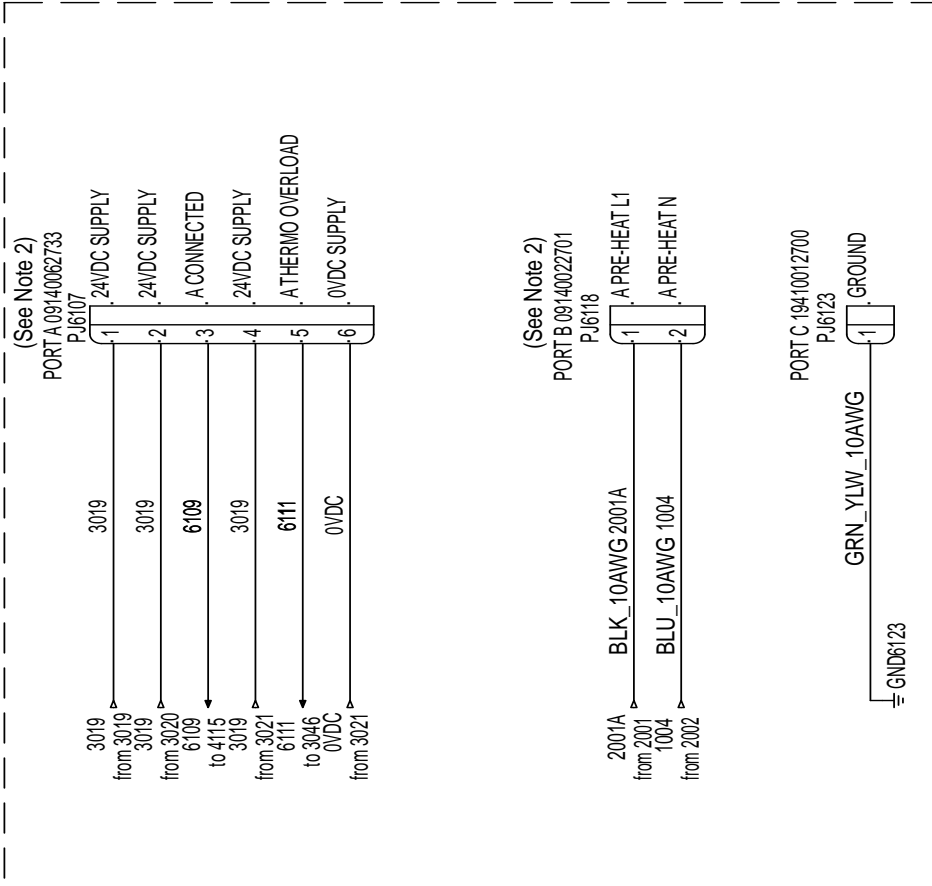

NOTE:

- Wire color and AWG - (Unless Noted)  
Blue - Ungrounded DC voltage - 18AWG  
White/Blue - Grounded DC Common - 18AWG  
Green/Yellow - Ground - 18AWG
- Ferrules not to be installed

01  
02  
03  
04  
05  
06  
07  
08  
09  
10  
11  
12  
13  
14  
15  
16  
17  
18  
19  
20  
21  
22  
23  
24  
25



DRAWING 14

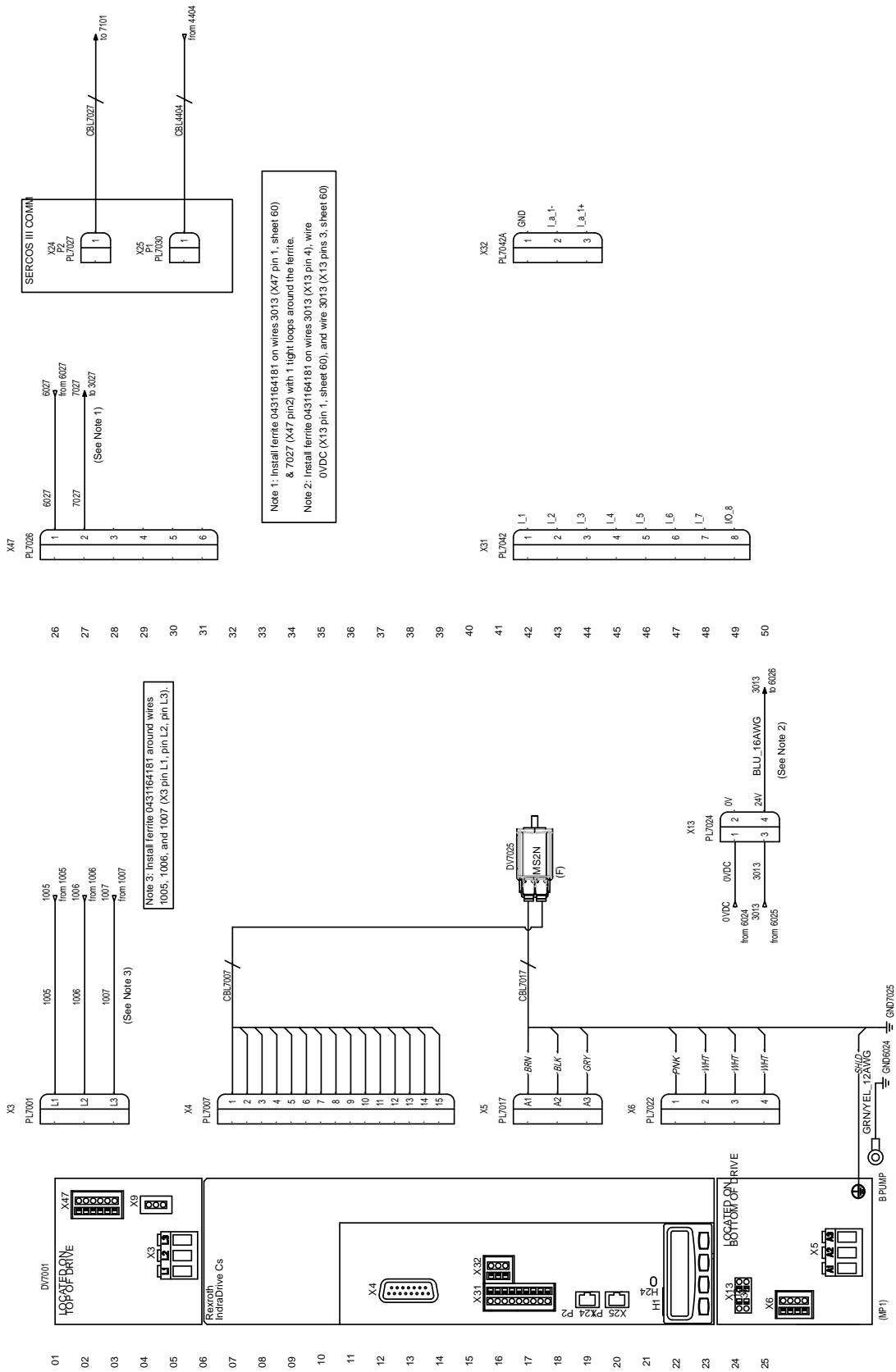

DRAWING 15

01  
02  
03  
04  
05  
06  
07  
08  
09  
10  
11  
12  
13  
14  
15  
16  
17  
18  
19  
20  
21  
22  
23  
24  
25

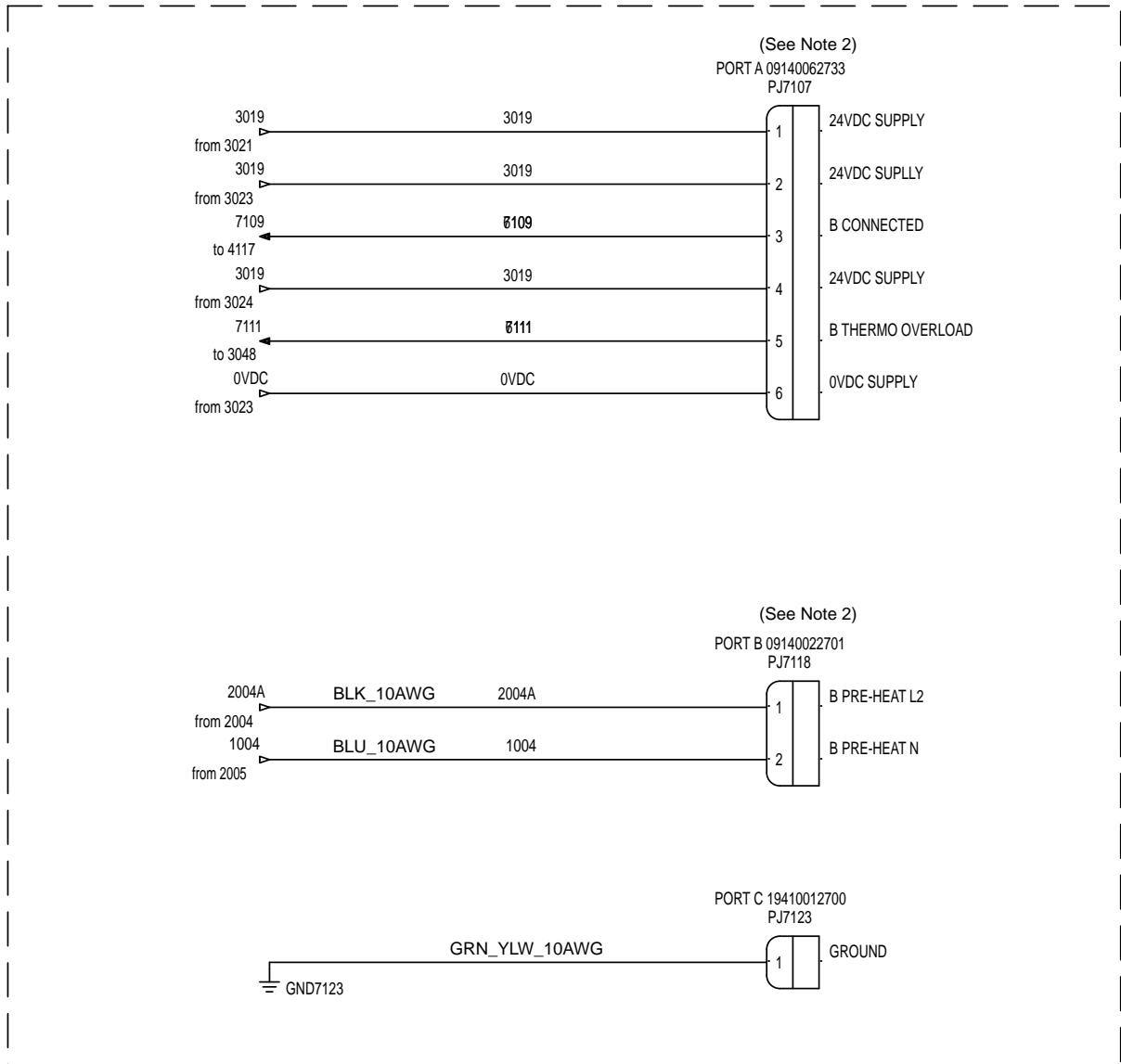
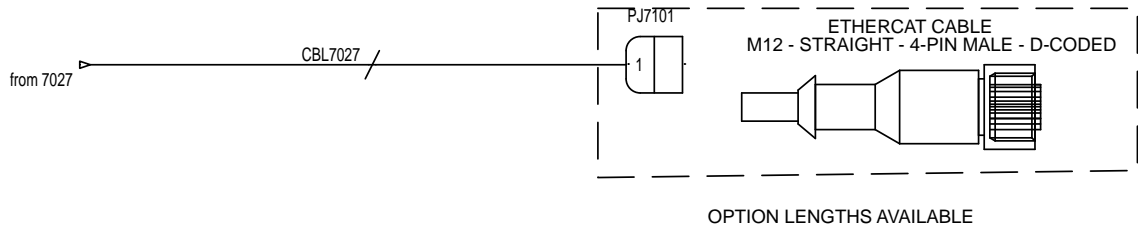

NOTE:  
1. Wire color and AWG - (Unless Noted)  
Blue - Ungrounded DC voltage - 18AWG  
White/Blue - Grounded DC Common - 18AWG  
Green/Yellow - Ground - 18AWG  
2. Ferrules not to be installed

DRAWING 16

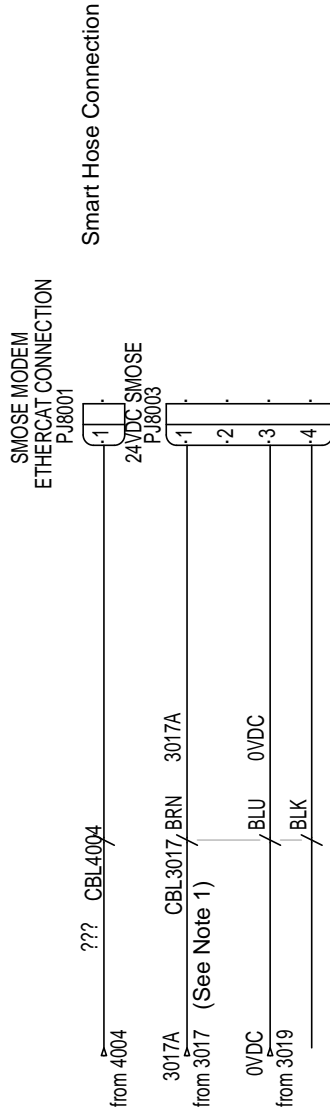

Note 1: Install ferrite 0431164181 on cable 3017 - (PJ8003 pin1) and (PJ8003 pin3) with 1 tight loop around the ferrite.

- 01
- 02
- 03
- 04
- 05
- 06
- 07
- 08
- 09
- 10
- 11
- 12
- 13
- 14
- 15
- 16
- 17
- 18
- 19
- 20
- 21
- 22
- 23
- 24
- 25

DRAWING 17

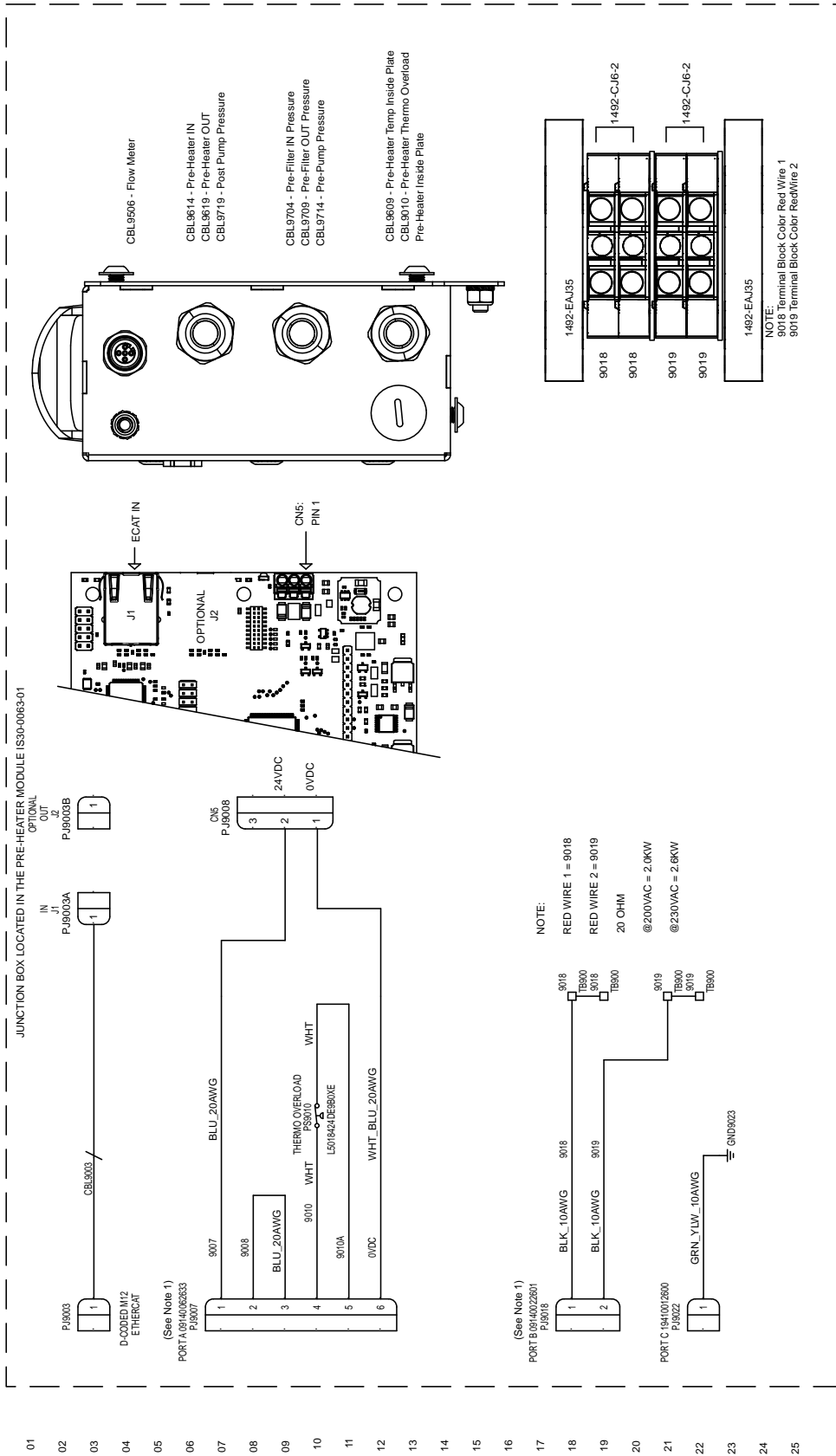

DRAWING 18

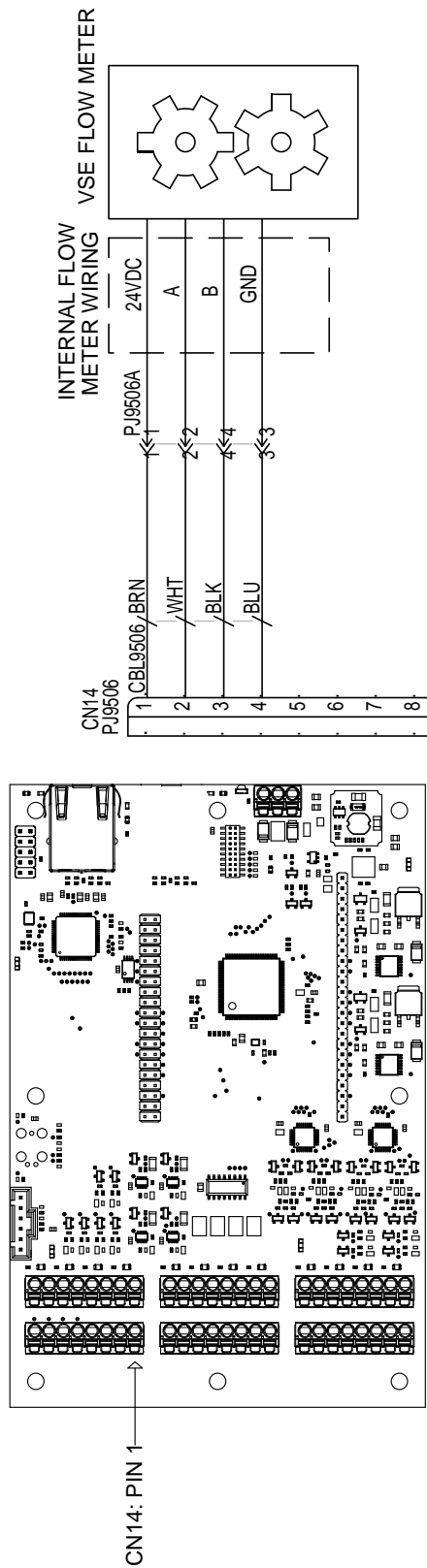

DRAWING 19

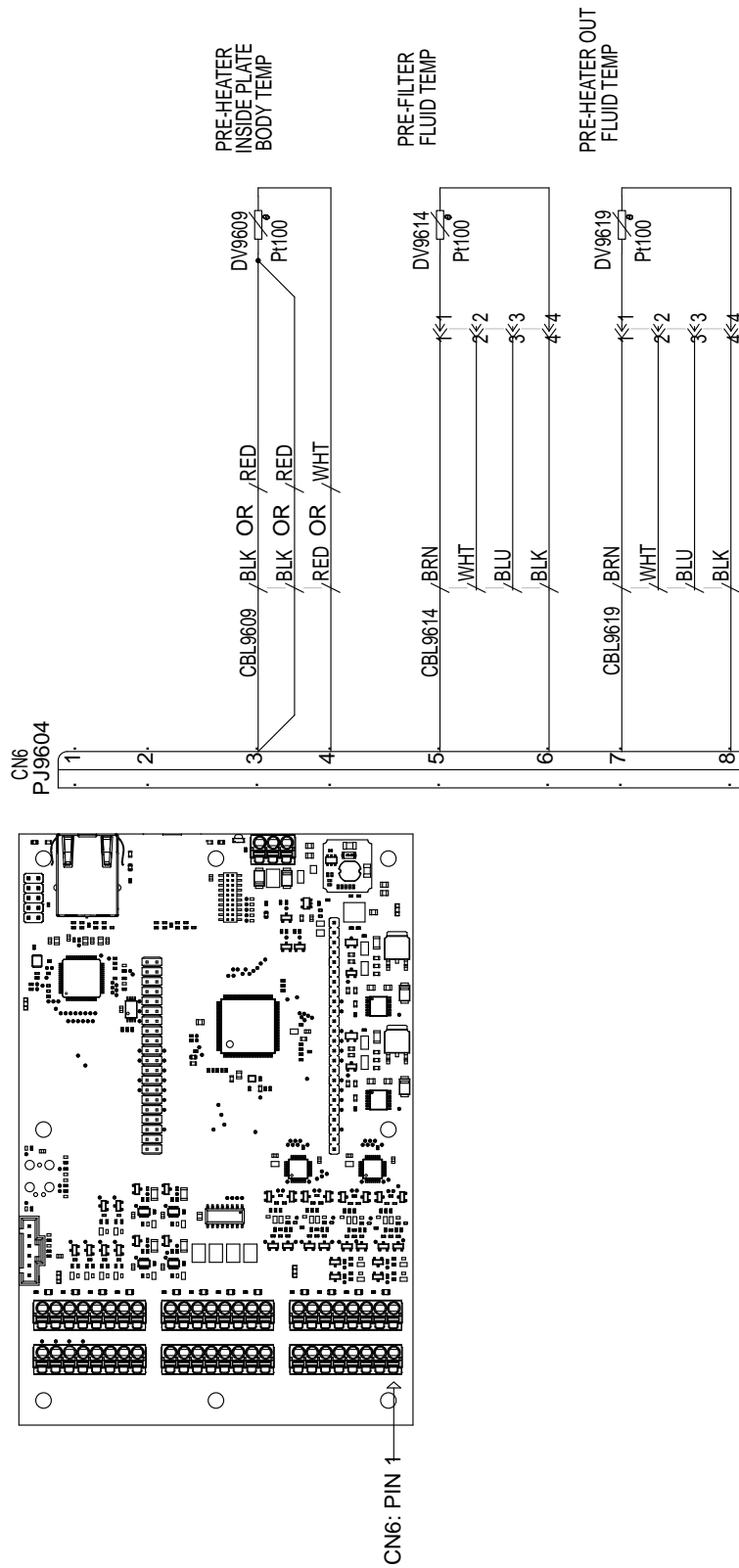

- 01
- 02
- 03
- 04
- 05
- 06
- 07
- 08
- 09
- 10
- 11
- 12
- 13
- 14
- 15
- 16
- 17
- 18
- 19
- 20
- 21
- 22
- 23
- 24
- 25



DRAWING 20

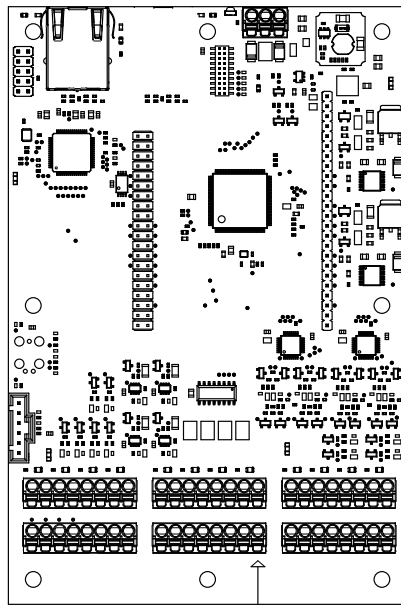
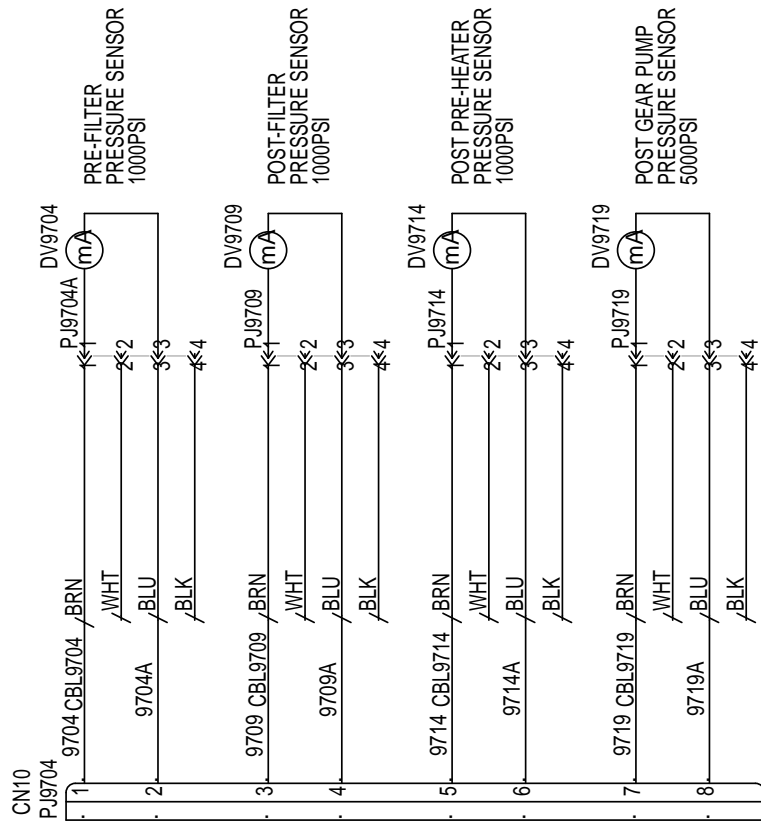

CN10: PIN 1

- 01
- 02
- 03
- 04
- 05
- 06
- 07
- 08
- 09
- 10
- 11
- 12
- 13
- 14
- 15
- 16
- 17
- 18
- 19
- 20
- 21
- 22
- 23
- 24
- 25

## ELECTRICAL DIAGRAMS

WIRE GAUGE (UNLESS NOTED) USE MIN 75 DEGREE C COPPER WIRE			
American Wire Gauge AWG)	Diameter (Inches)	Cross Sectional Area (mm <sup>2</sup> )	Ampacity (75° C Copper)
3	0.2292	26.65	100
4	0.2043	21.14	85
6	0.162	13.29	65
8	0.1285	8.36	52
10	0.1019	5.26	30
12	0.0808	3.31	20
14	0.0641	2.08	15
16	0.0508	1.31	10
18	0.0403	0.82	7
20	0.0320	0.52	5
22	0.0253	0.33	3

FERRULES TO BE USED ON ALL WIRES (UNLESS NOTED)	
Wire Reference	Description
BLACK	UNGROUND LINE VOLTAGE
WHITE	UNGROUND DC VOLTAGE
WHITE/BLUE	GROUND DC COMMON
GREEN/YELLOW	GROUND

WIRE REFERENCE	COLOR
BLK	Black
WHT	White
BLU	Blue
RED	Red
GRN	Green
ORG	Orange
BRN	Brown
YLW	Yellow

WIRE REFERENCE	COLOR
RED_GRY	RED w/GREY STRIPE
GRY_RED	GREY w/WHITE STRIPE
WHT_BRN	WHITE w/BROWN STRIPE
BRN_WHT	BROWN w/WHITE STRIPE
WHT_GRY	WHITE w/GREY STRIPE
GRY_WHT	GREY w/WHITE STRIPE
RED_BLU	RED w/BLUE STRIPE
BLU/RED	BLUE w/RED STRIPE
RED/ORG	RED w/ORANGE STRIPE
ORG/RED	ORANGE w/RED STRIPE
RED/GRN	RED w/GREEN STRIPE
GRN_RED	GREEN w/RED STRIPE
BRN_RED	BROWN w/RED STRIPE
RED_BRN	RED w/BROWN STRIPE
WHT_GRN	WHITE w/GREEN STRIPE
GRN_WHT	GREEN w/WHITE STRIPE
WHT_BLU	WHITE w/BLUE STRIPE
BLU_WHT	BLUE w/WHITE STRIPE
WHT_ORG	WHITE w/ORANGE STRIPE
ORG_WHT	ORANGE w/WHITE STRIPE

CABLE NUMBER	CABLE TYPE	PART NUMBER
CBL4004	CAT6	NA
CBL4208	FACTORY CABLE	NA
CBL4211	FACTORY CABLE	NA
CBL4214	M12	NA
CBL4302	FACTORY CABLE	NA
CBL4408	FACTORY CABLE	NA
CBL4420	FACTORY CABLE	NA
CBL4511	BULK CABLE	NA
CBL4517	FACTORY CABLE	NA
CBL4520	FACTORY CABLE	NA
CBL4602	FACTORY CABLE	NA
CBL4610	FACTORY CABLE	NA
CBL5007	CAT6	NA
CBL5020	CAT6	NA
CBL5518	CAT6	NA

DRAWING 1

LEGEND DESCRIPTIONS

NUMBERING CODE

XX???? = COMPONENT TYPE

??XX?? = SHEET

????XX = COLUMN

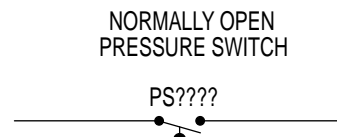
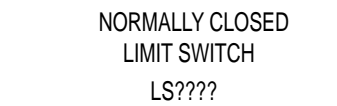
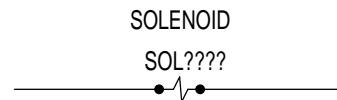
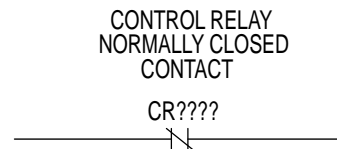
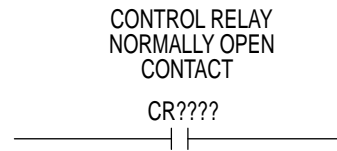
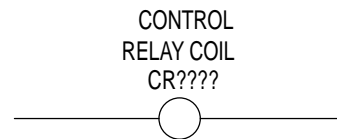
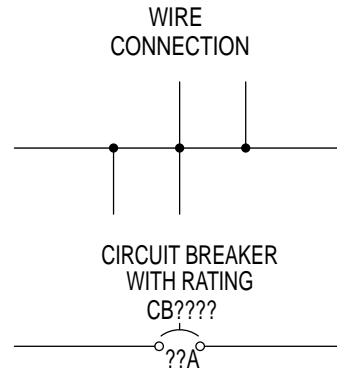
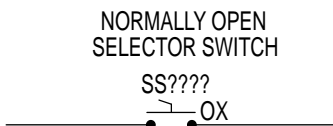
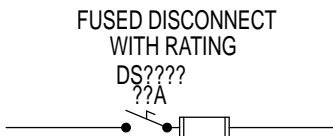
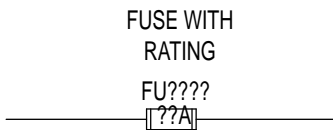
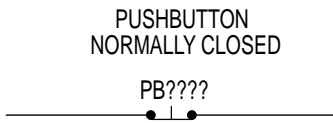
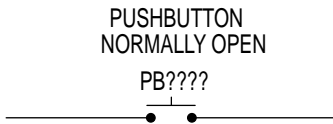
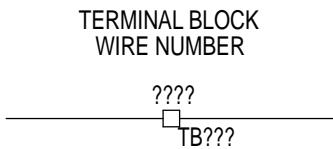
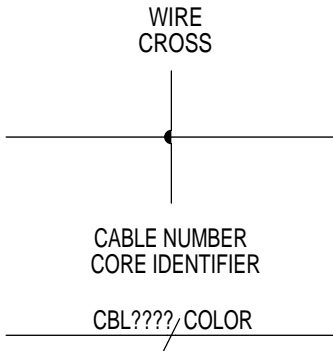

DRAWING 2

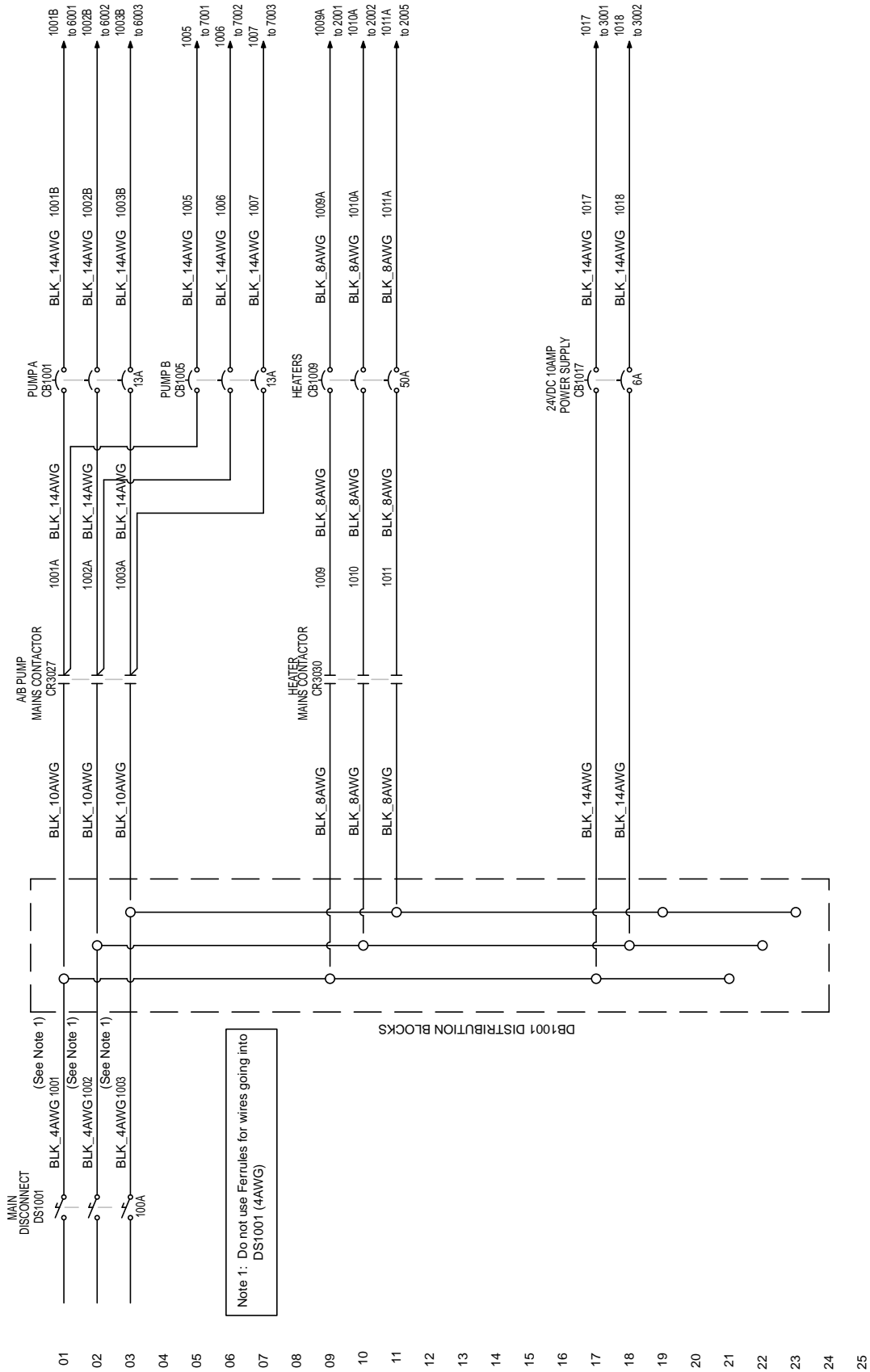

Note 1: Do not use Ferrules for wires going into DS1001 (4AWG)

NOTE:  
 CUSTOMER SUPPLIED  
 200-240VAC, 80AMP, 3PH, 60HZ  
 USE 75 DEGREE COPPER WIRE ONLY

DRAWING 3

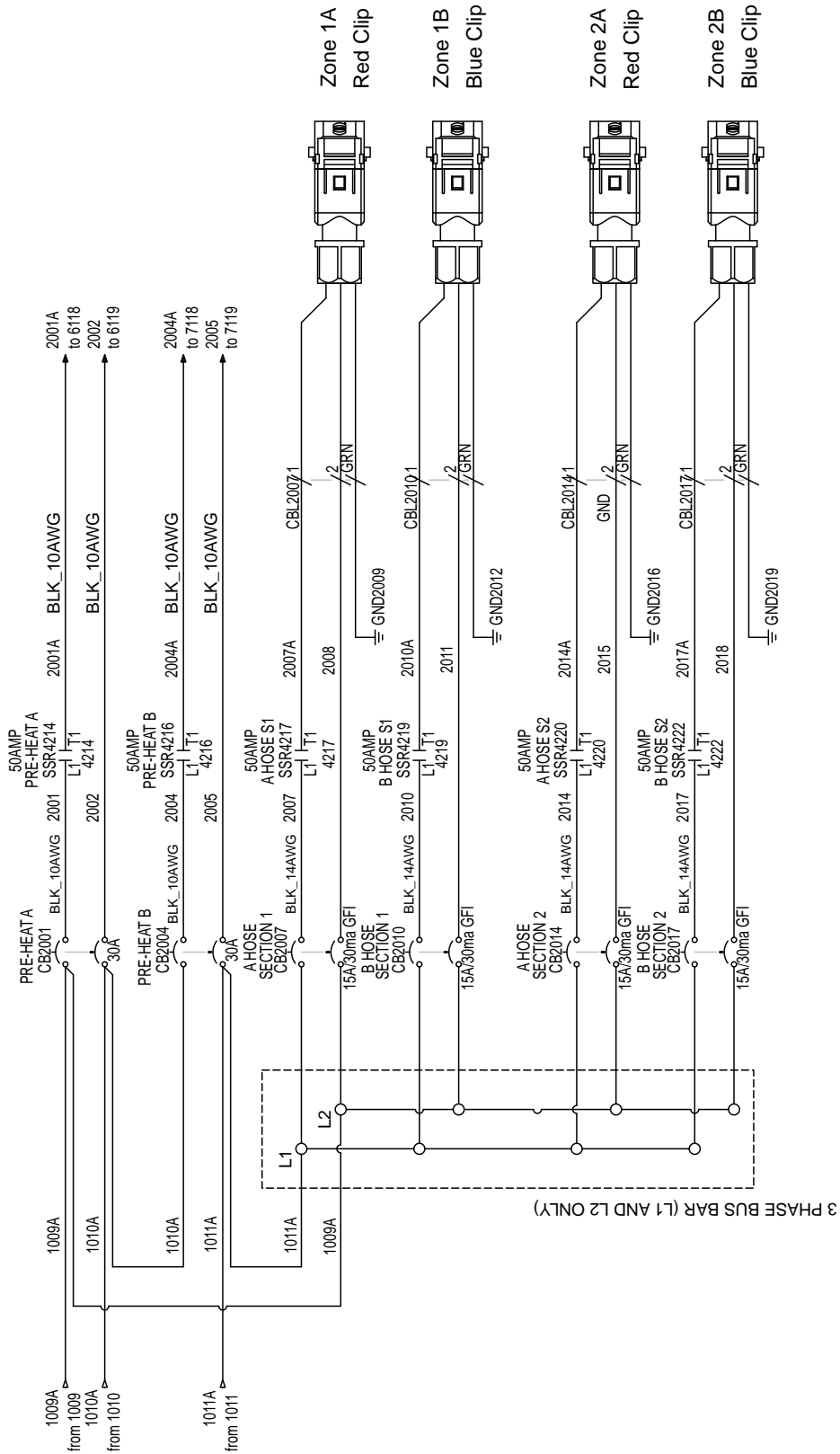



DRAWING 4

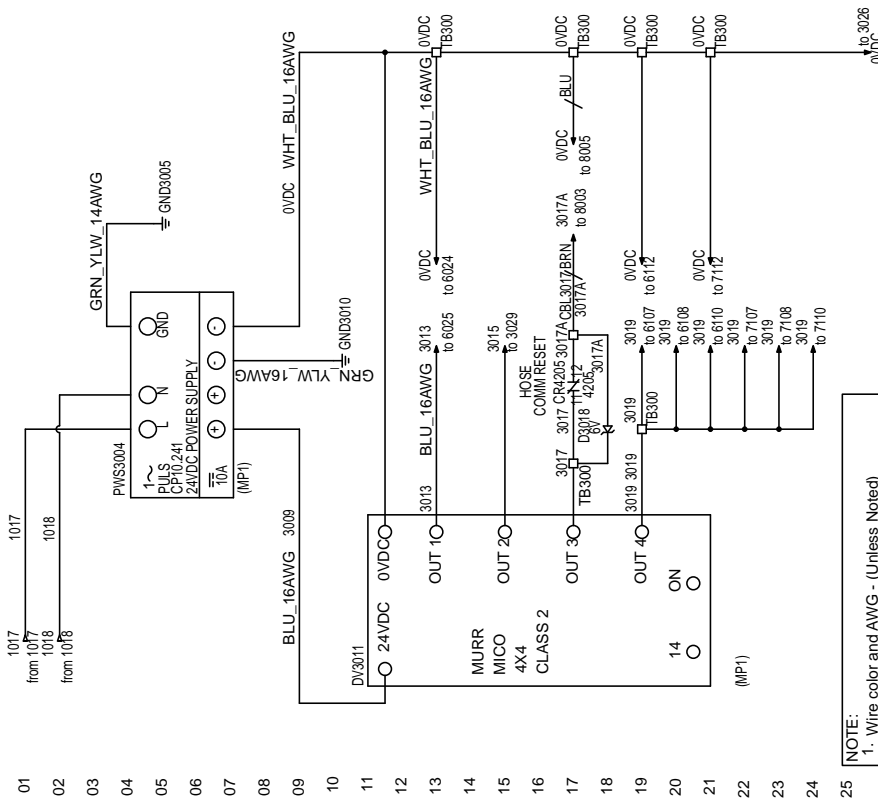
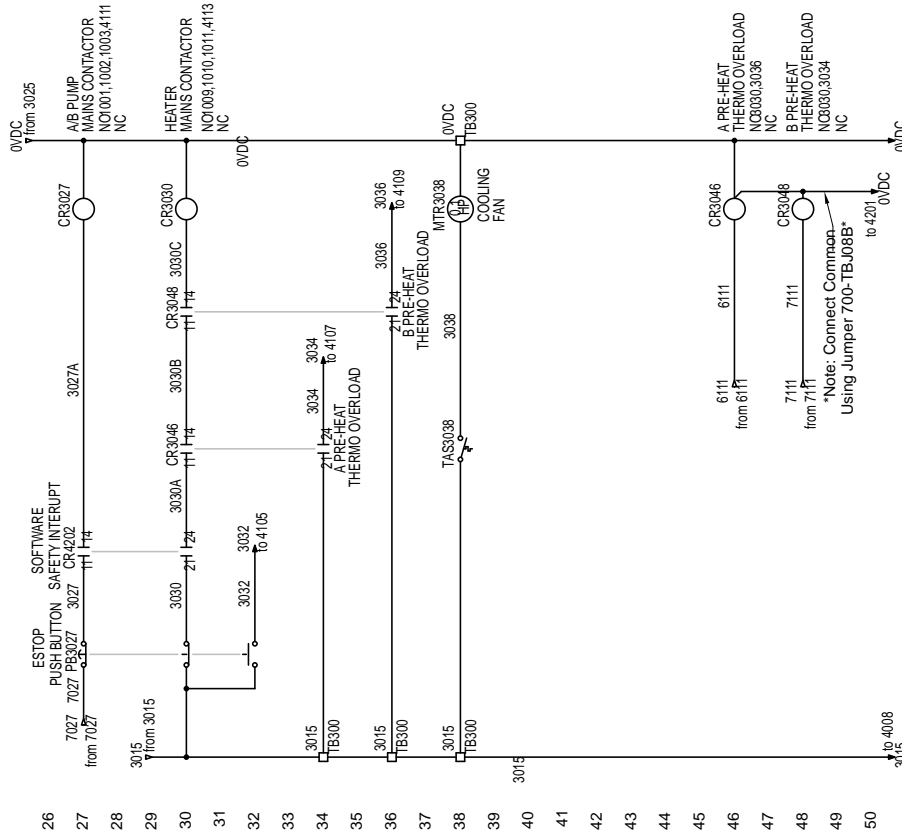

DRAWING 5

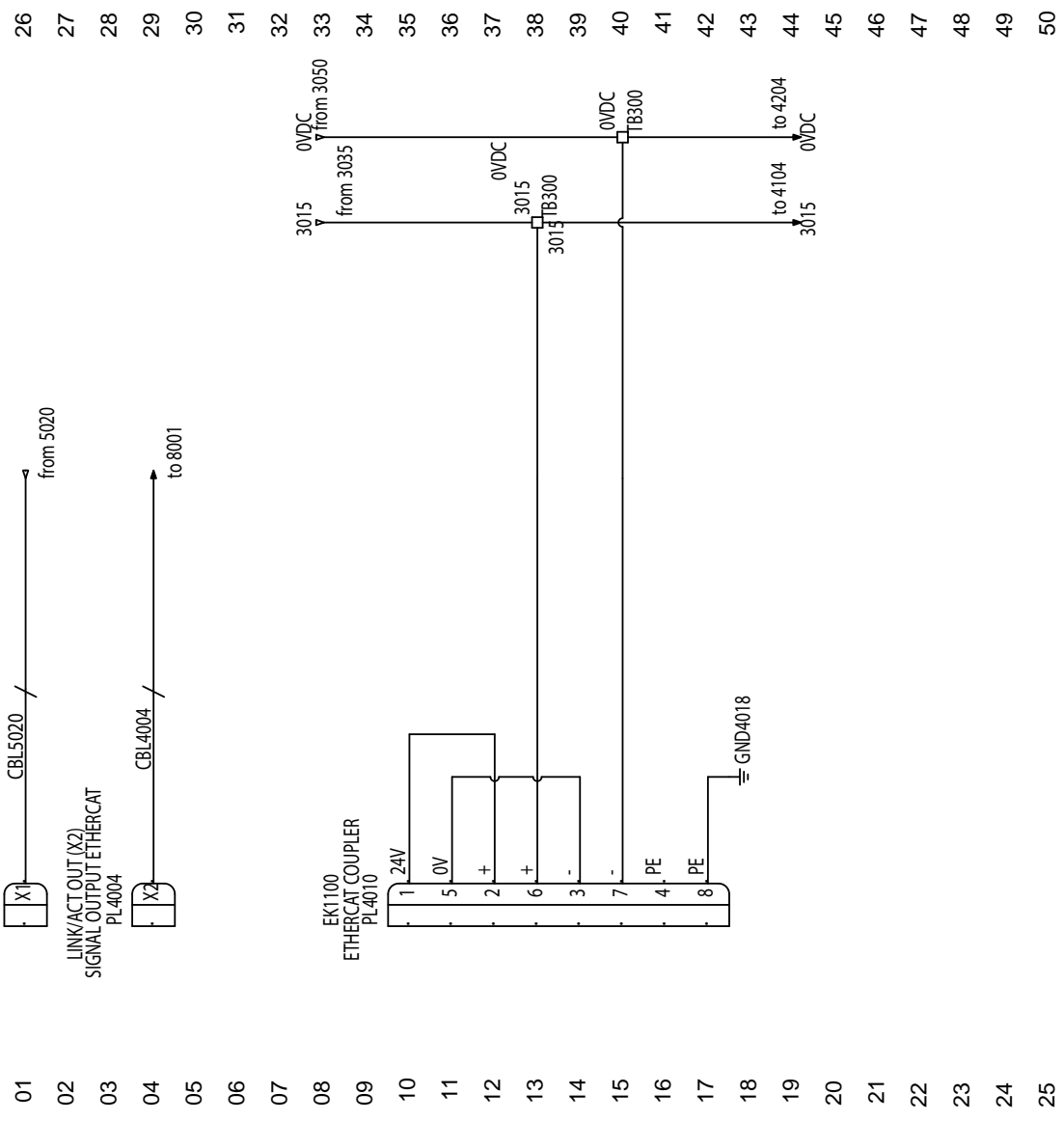
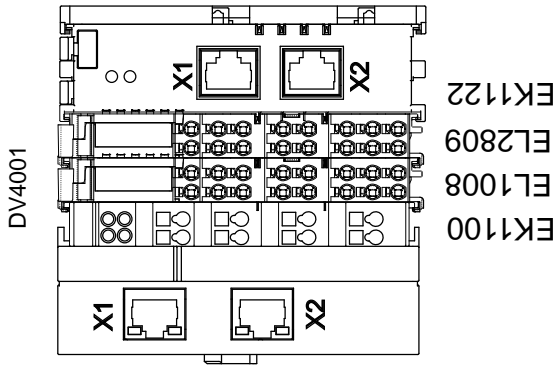

NOTE: Wire color and AWG - (Unless Noted)  
 1. - Light colored for 18AWG - 18AWG  
 White/Blue - Common - 18AWG  
 Green/Yellow - Ground - 18AWG

DRAWING 6

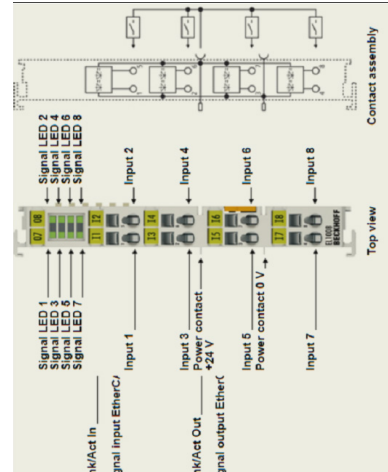
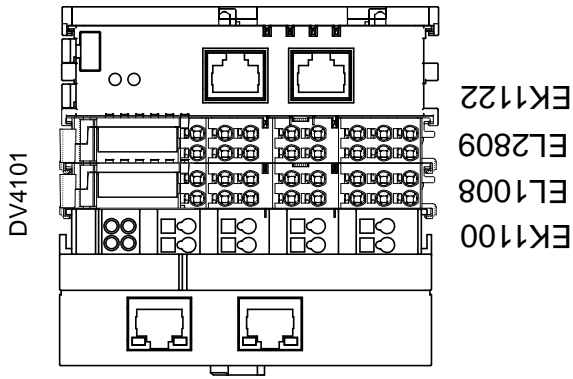

26  
27  
28  
29  
30  
31  
32  
33  
34  
35  
36  
37  
38  
39  
40  
41  
42  
43  
44  
45  
46  
47  
48  
49  
50

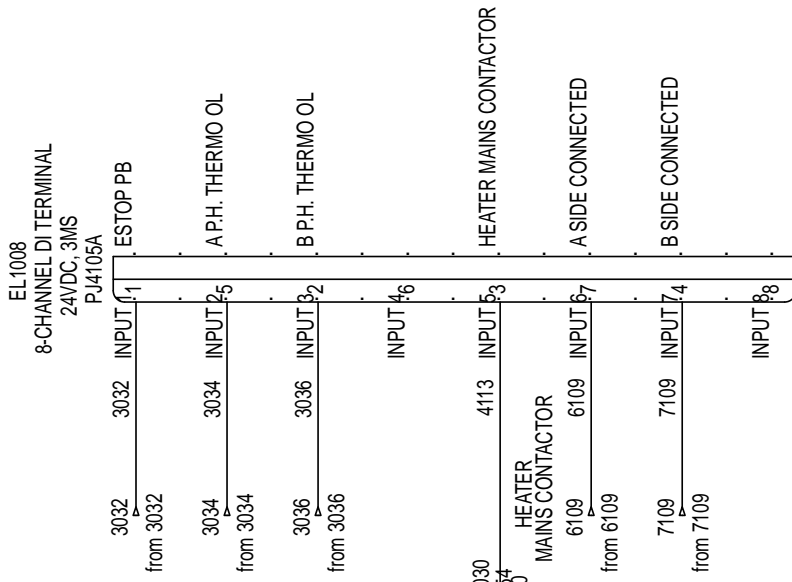

01  
02  
03  
04  
05  
06  
07  
08  
09  
10  
11  
12  
13  
14  
15  
16  
17  
18  
19  
20  
21  
22  
23  
24  
25

NOTE:  
1. Wire color and AWG - (Unless Noted)  
Blue - Ungrounded DC voltage - 18AWG  
White/Blue - Grounded DC Common - 18AWG  
Green/Yellow - Ground - 18AWG

DRAWING 7

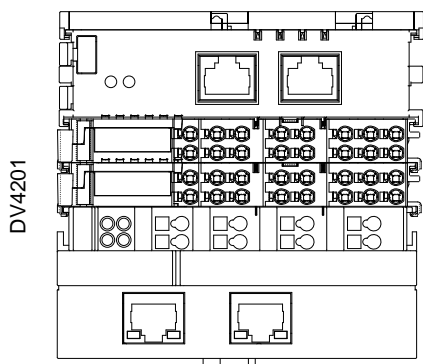

EK1122  
EL2809  
EL1008  
EK1100

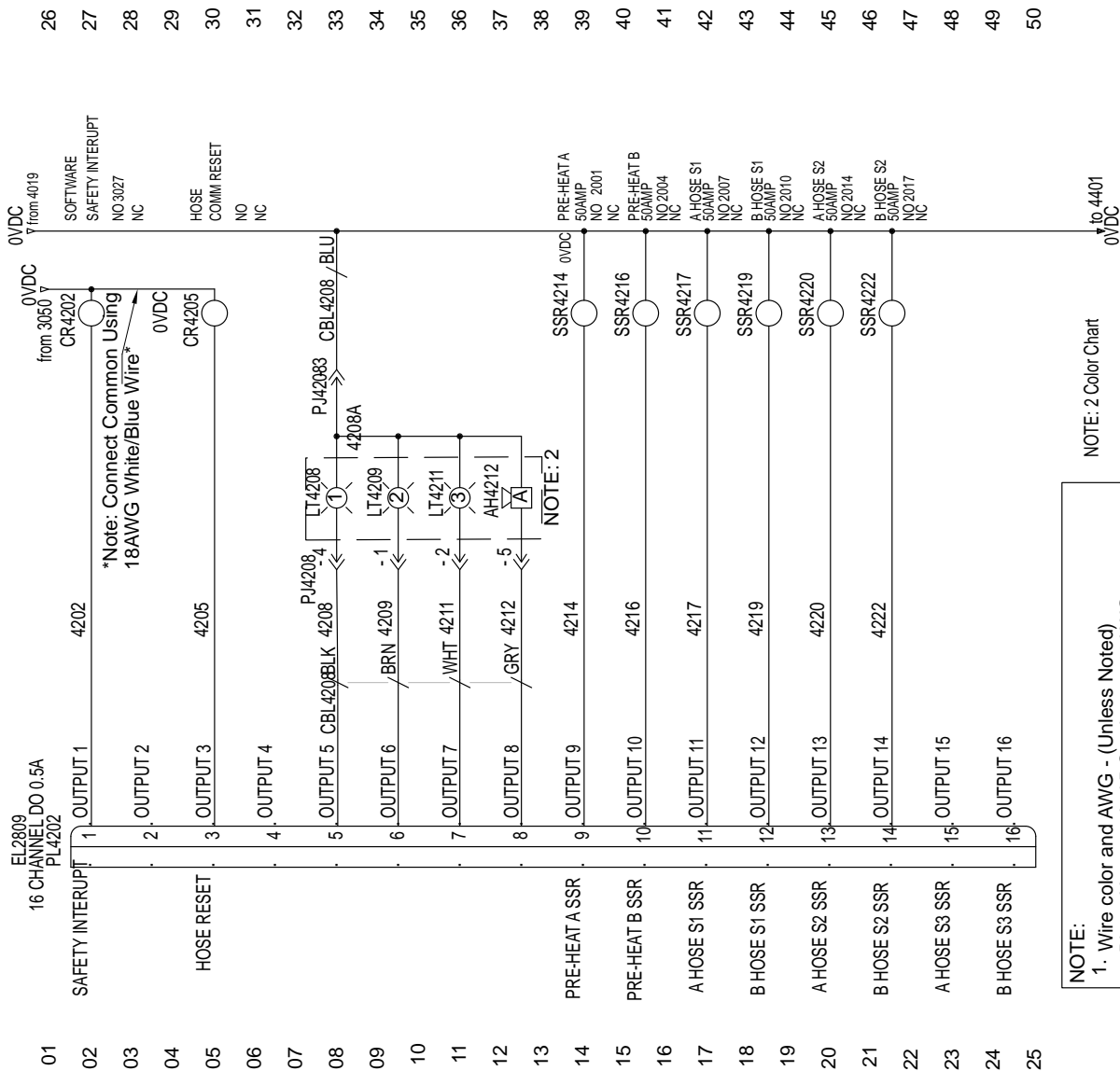
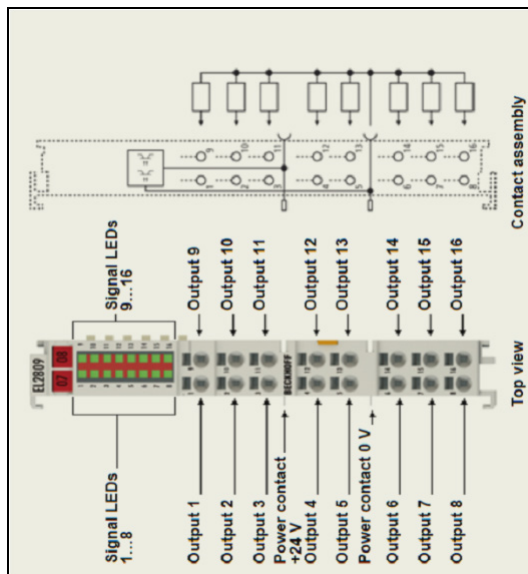

NOTE:  
1. Wire color and AWG - (Unless Noted)  
Blue - Ungrounded DC voltage - 18AWG  
White/Blue - Grounded DC Common - 18AWG  
Green/Yellow - Ground - 18AWG

DRAWING 8

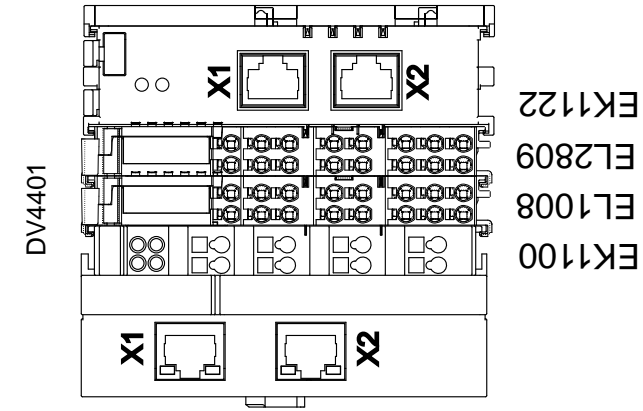

26  
27  
28  
29  
30  
31  
32  
33  
34  
35  
36  
37  
38  
39  
40  
41  
42  
43  
44  
45  
46  
47  
48  
49  
50

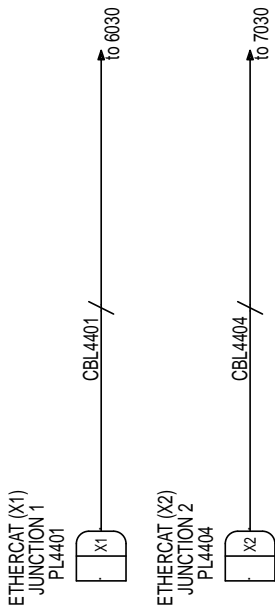

01  
02  
03  
04  
05  
06  
07  
08  
09  
10  
11  
12  
13  
14  
15  
16  
17  
18  
19  
20  
21  
22  
23  
24  
25

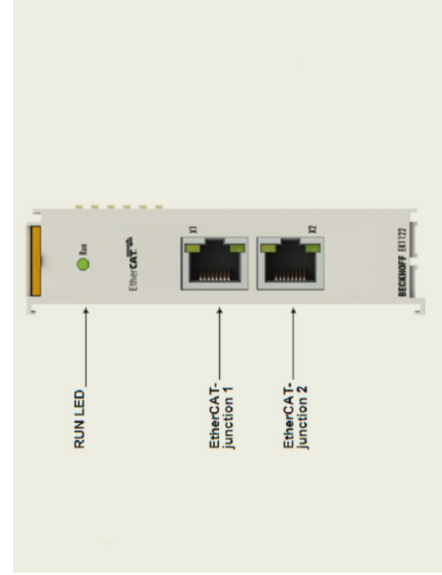

NOTE:  
1. Wire color and AWG - (Unless Noted)  
Blue - Ungrounded DC voltage - 18AWG  
White/Blue - Grounded DC Common - 18AWG  
Green/Yellow - Ground - 18AWG

DRAWING 9

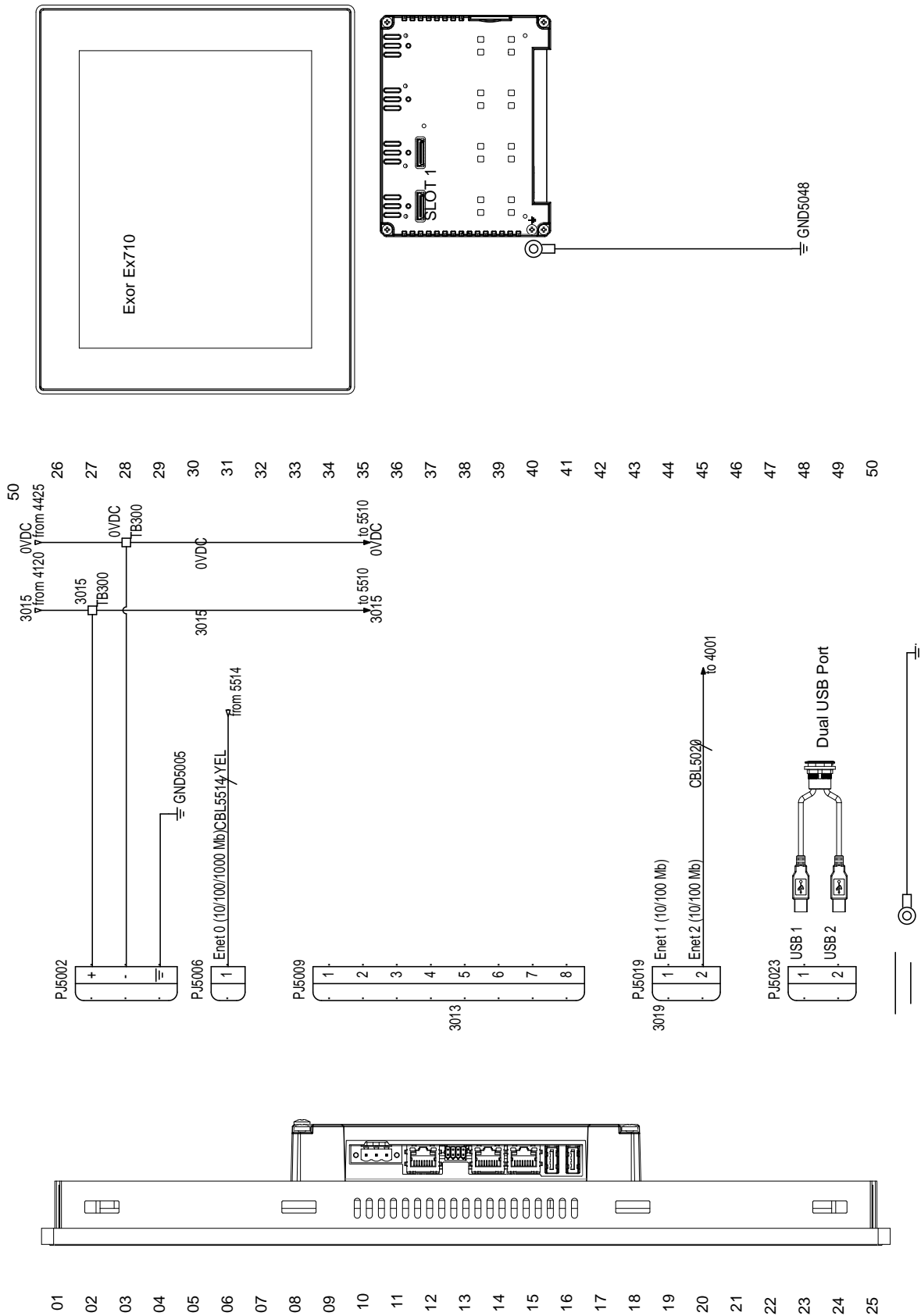



DRAWING 10

Remote Connectivity Kit Part# IS30-0149

DV5501

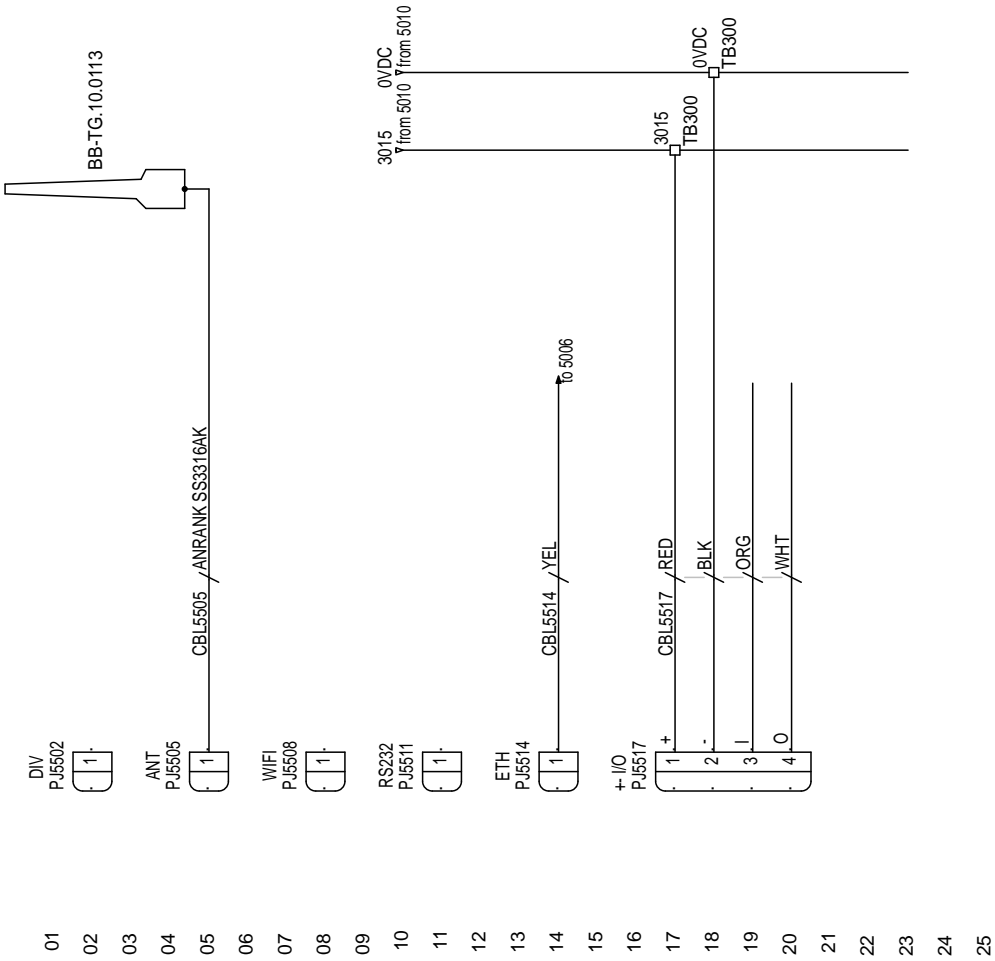

**NOTE:**  
 1. Wire color and AWG - (Unless Noted)  
 Blue - Ungrounded DC voltage - 18AWG  
 White/Blue - Grounded DC Common - 18AWG  
 Green/Yellow - Ground - 18AWG

DRAWING 11

Remote Connectivity Kit Part# IS30-0173

DV5501

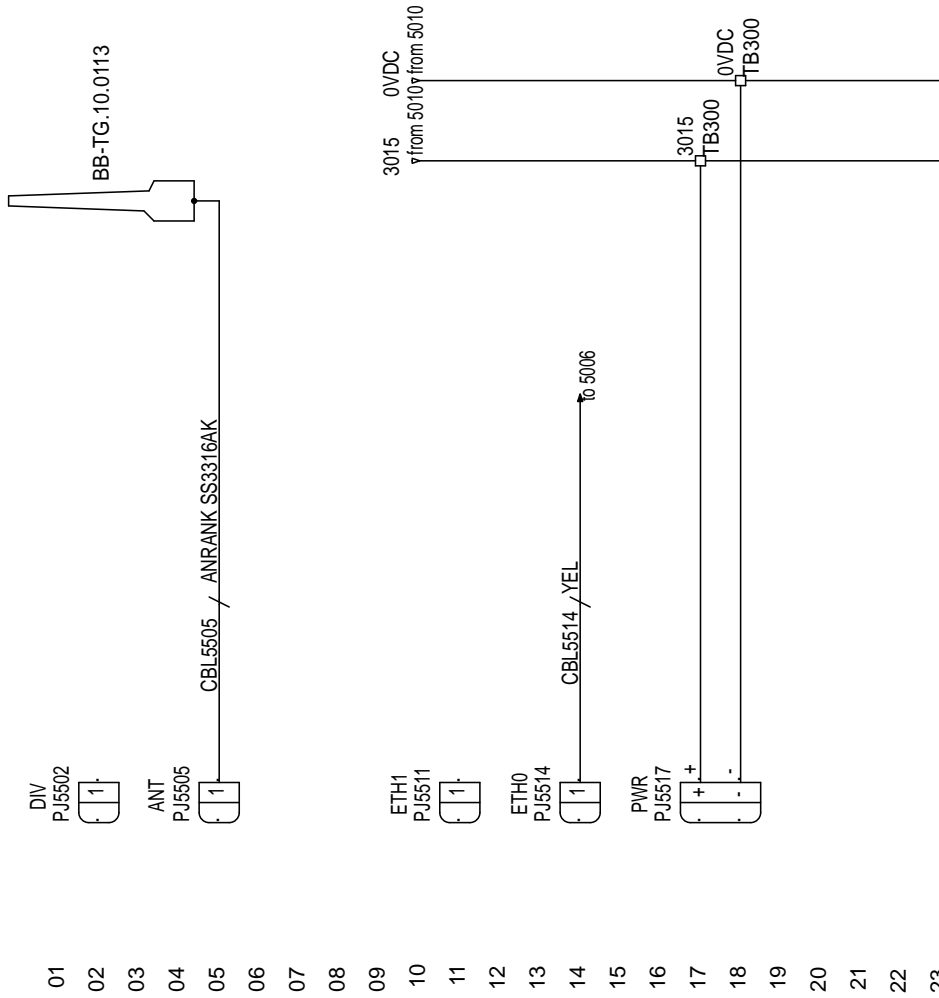

DRAWING 12

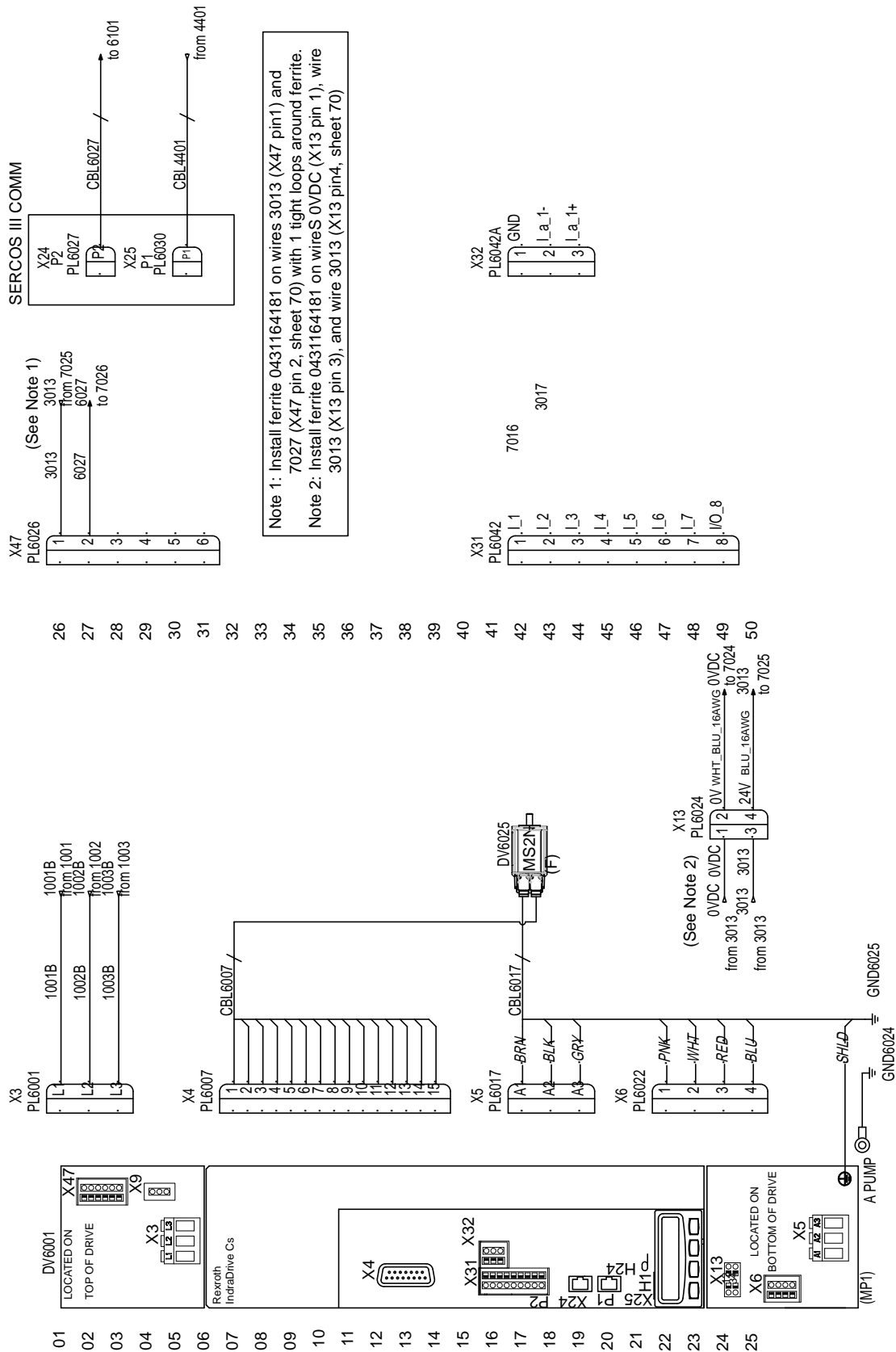

DRAWING 13

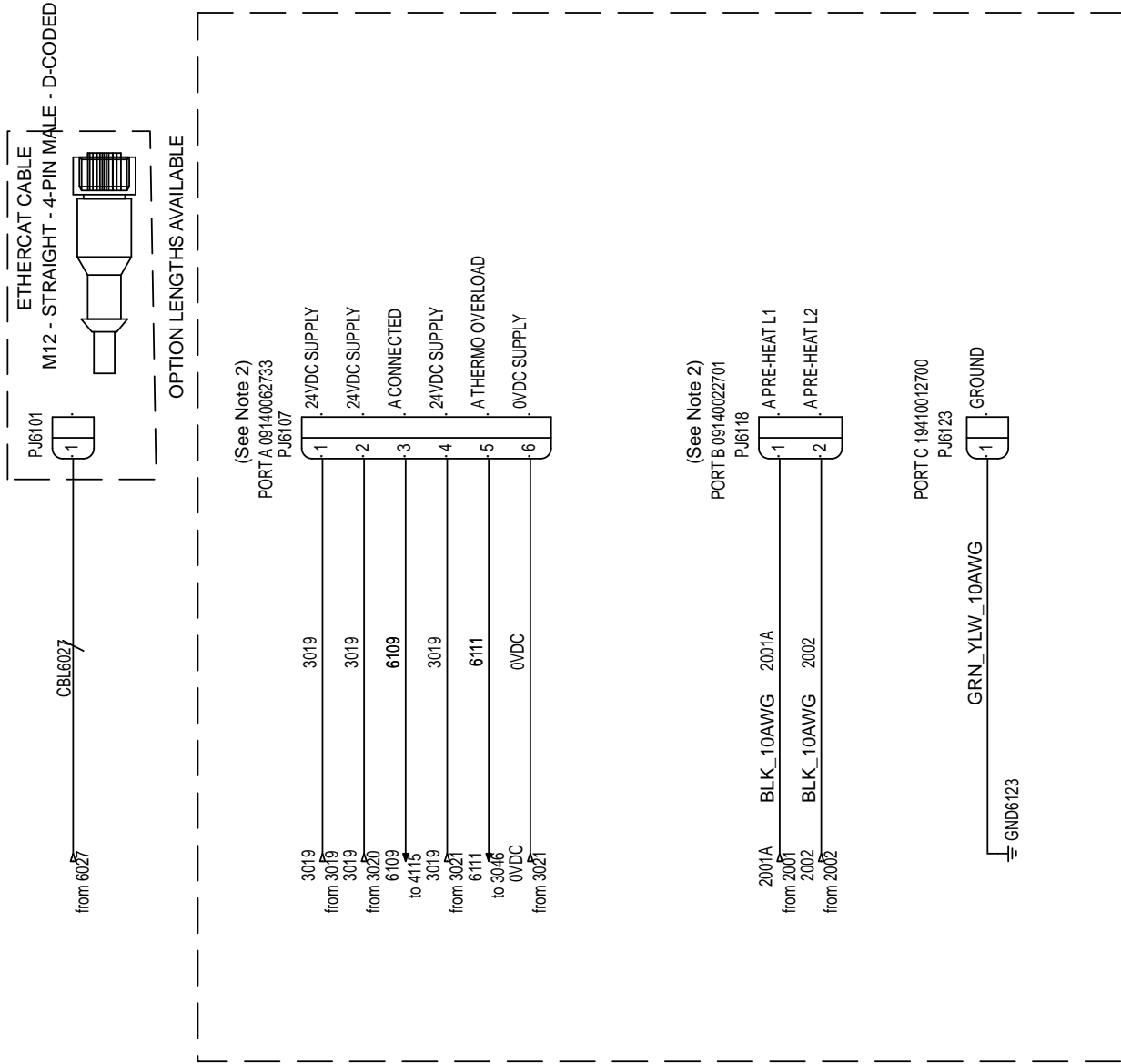

NOTE:  
1. Wire color and AWG - (Unless Noted)  
Blue - Ungrounded DC voltage - 18AWG  
White/Blue - Grounded DC Common - 18AWG  
Green/Yellow - Ground - 18AWG  
2. Ferrules not to be installed

01  
02  
03  
04  
05  
06  
07  
08  
09  
10  
11  
12  
13  
14  
15  
16  
17  
18  
19  
20  
21  
22  
23  
24  
25

DRAWING 14

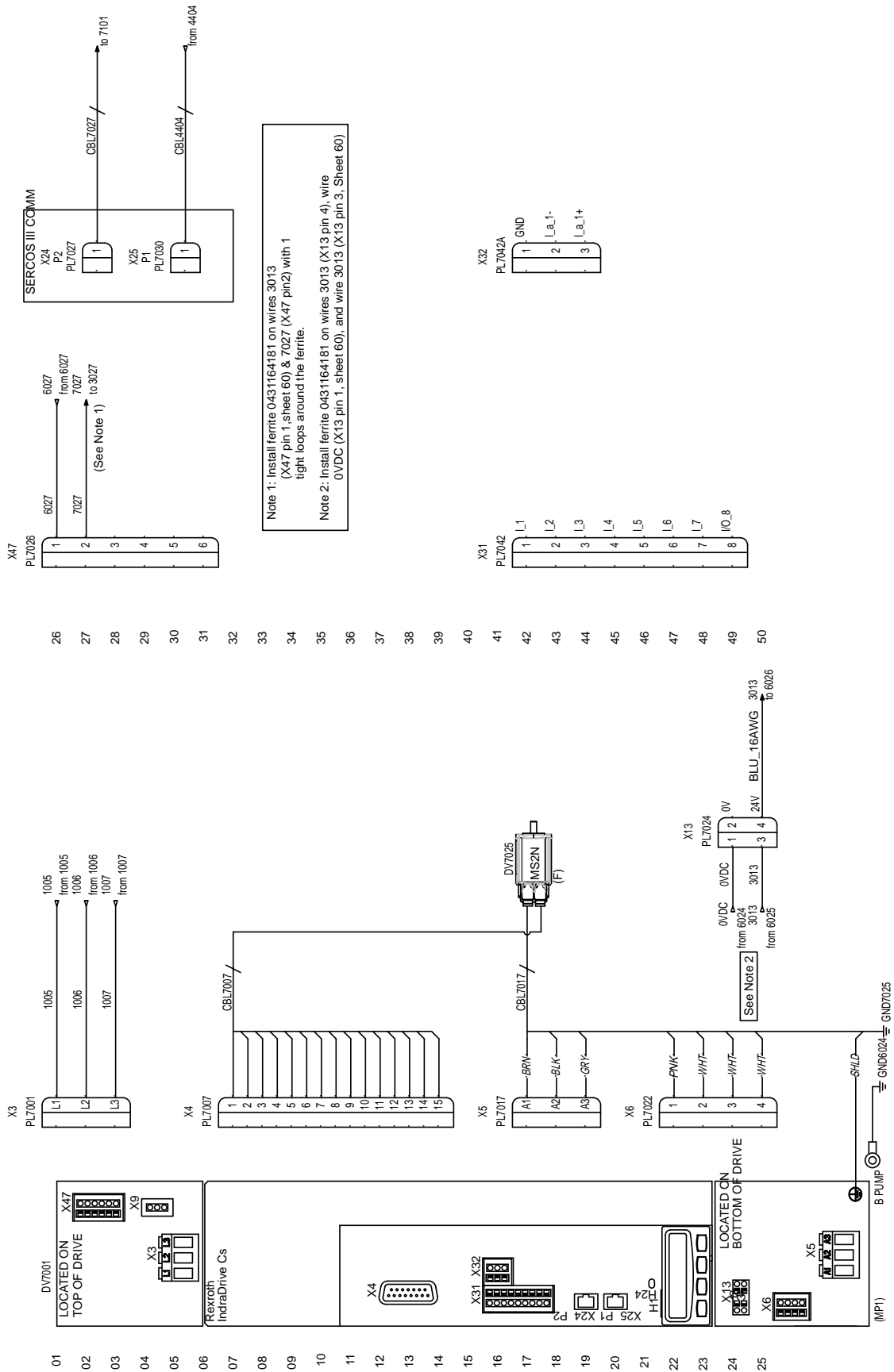

01  
02  
03  
04  
05  
06  
07  
08  
09  
10  
11  
12  
13  
14  
15  
16  
17  
18  
19  
20  
21  
22  
23  
24  
25

26  
27  
28  
29  
30  
31  
32  
33  
34  
35  
36  
37  
38  
39  
40  
41  
42  
43  
44  
45  
46  
47  
48  
49  
50

DRAWING 15

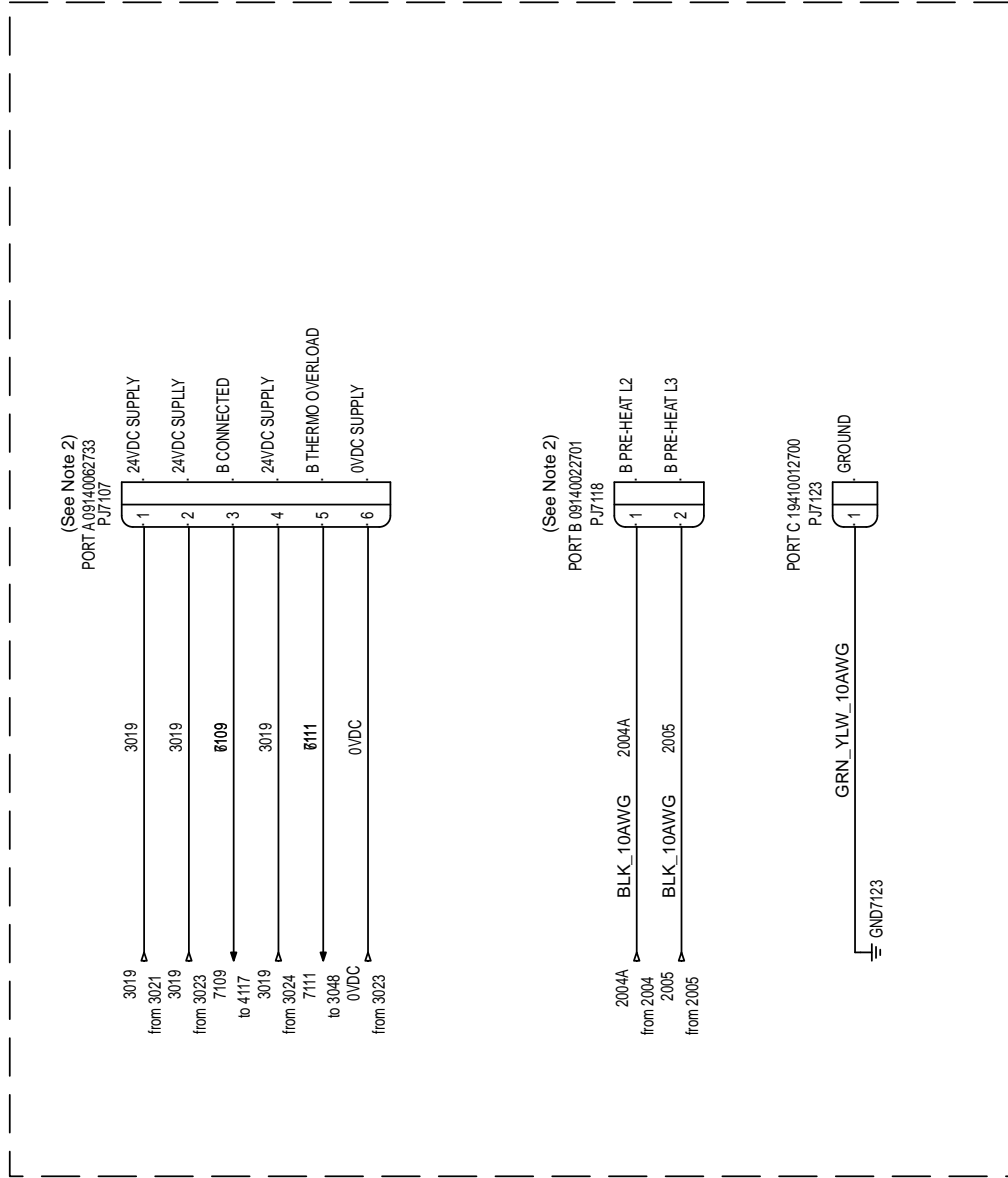
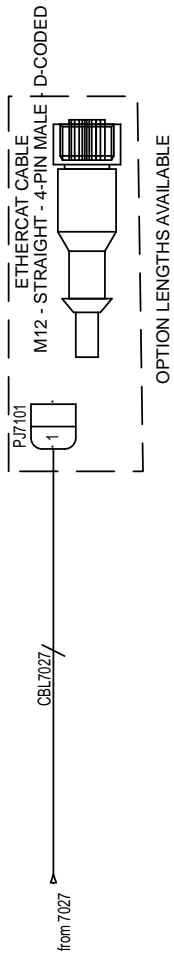

- 01
- 02
- 03
- 04
- 05
- 06
- 07
- 08
- 09
- 10
- 11
- 12
- 13
- 14
- 15
- 16
- 17
- 18
- 19
- 20
- 21
- 22
- 23
- 24
- 25

**NOTE:**  
 1. Wire color and AWG - (Unless Noted)  
 Blue - Ungrounded DC voltage - 18AWG  
 White/Blue - Grounded DC Common - 18AWG  
 Green/Yellow - Ground - 18AWG  
 2. Ferrules not to be installed

DRAWING 16

Smart Hose Connection

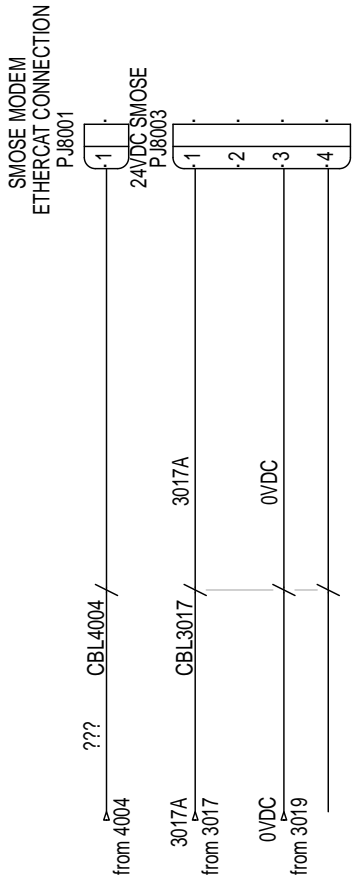

- 01
- 02
- 03
- 04
- 05
- 06
- 07
- 08
- 09
- 10
- 11
- 12
- 13
- 14
- 15
- 16
- 17
- 18
- 19
- 20
- 21
- 22
- 23
- 24
- 25



DRAWING 17

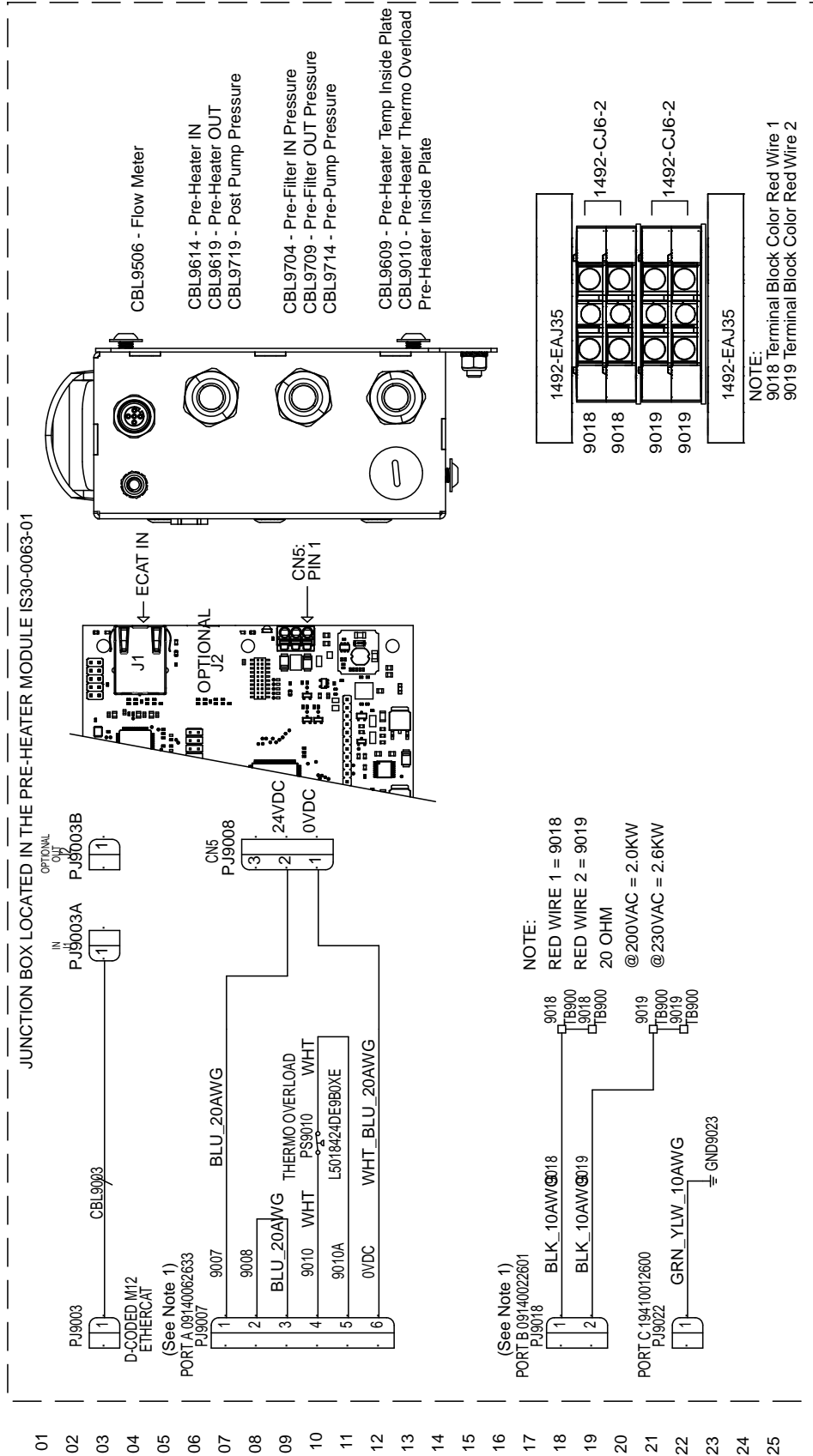

NOTE:  
1. Ferrules not to be installed

DRAWING 18

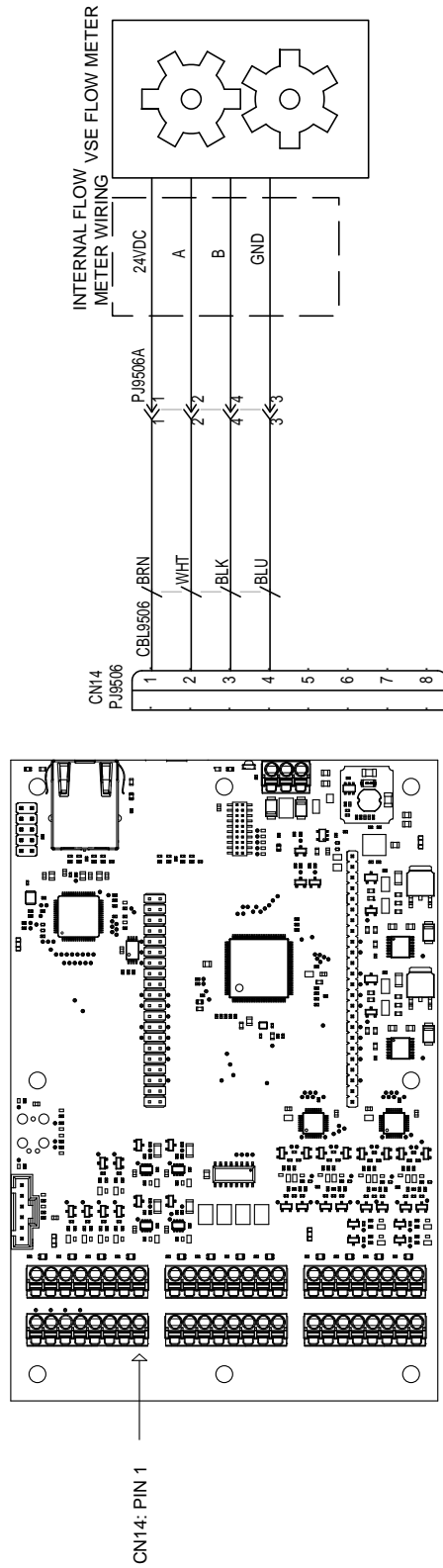

- 01
- 02
- 03
- 04
- 05
- 06
- 07
- 08
- 09
- 10
- 11
- 12
- 13
- 14
- 15
- 16
- 17
- 18
- 19
- 20
- 21
- 22
- 23
- 24
- 25

DRAWING 19

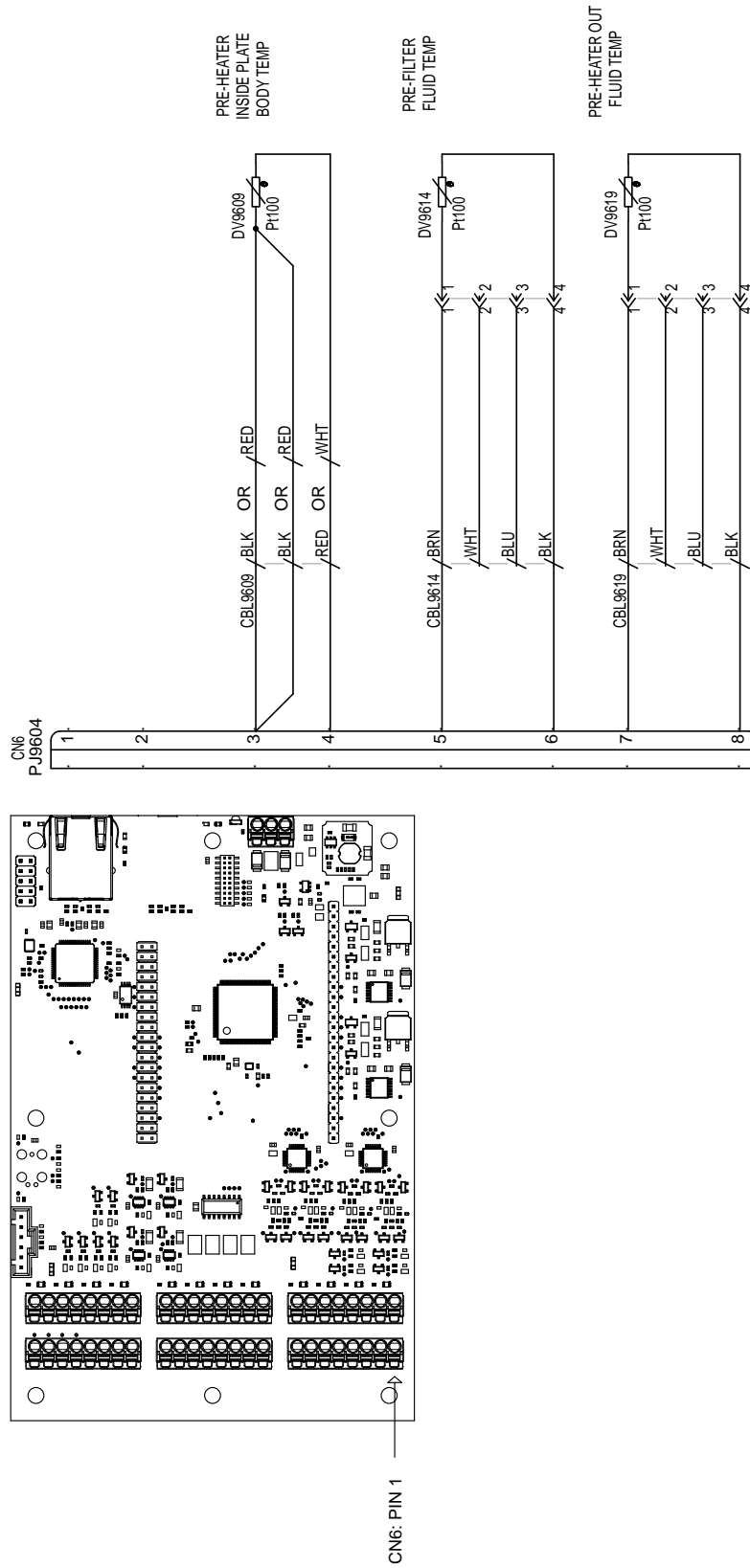

- 01
- 02
- 03
- 04
- 05
- 06
- 07
- 08
- 09
- 10
- 11
- 12
- 13
- 14
- 15
- 16
- 17
- 18
- 19
- 20
- 21
- 22
- 23
- 24
- 25

DRAWING 20

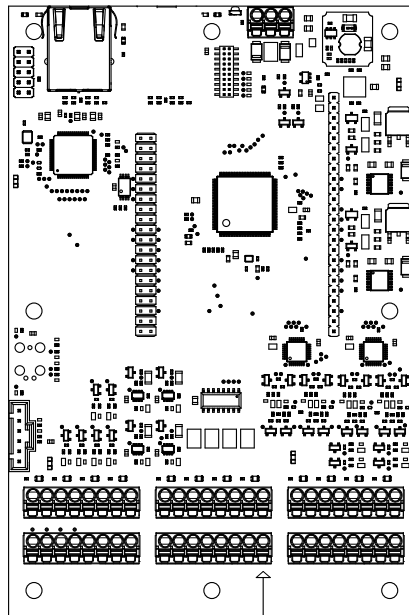
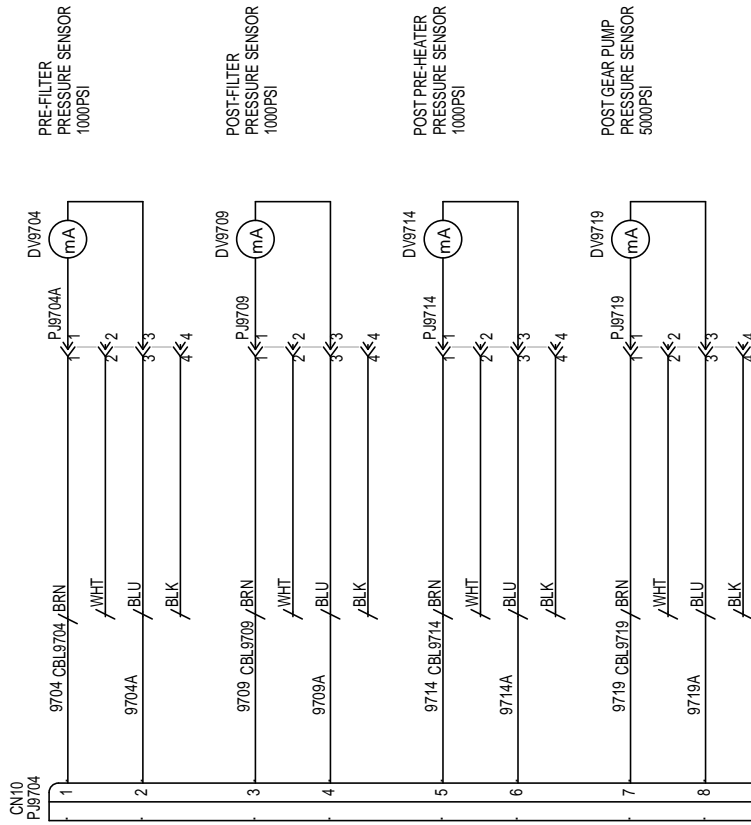

CN10: PIN 1

- 01
- 02
- 03
- 04
- 05
- 06
- 07
- 08
- 09
- 10
- 11
- 12
- 13
- 14
- 15
- 16
- 17
- 18
- 19
- 20
- 21
- 22
- 23
- 24
- 25

## REMOTE ACCESS

Remote access to IntelliSpray systems is via the IntelliSpray Cloud (ISC), a virtual gateway to all systems accessible to registered users. The ISC URL (web address) is provided when purchasing an IntelliSpray Proportioner. Remote access to IntelliSpray systems is a simple two-step process requiring a computer, tablet, or phone with a web browser.

IntelliSpray Authorized Service Providers and/or trained Rig Administrators provide username and password access to the ISC and individual IS30s. Users or Rig Owners can also disable or enable Remote Access from the System Settings screen on the IS30. Instructions for ISC Administrators are contained in the document "IntelliSpray Cloud Administrator Instructions."

**Note:** To support remote service (including remote software upgrades), all IntelliSpray systems are factory-configured to allow access by IntelliSpray Service Engineers and/or Authorized Service Providers.

### STEP 1. Select IS30 IntelliSpray Cloud

An example of the ISC gateway shown in a standard browser is shown in the following figure.

Each device has a unique serial number (SN) loaded at the factory corresponding to the serial tag inside the control module. The SN is shown at the top of all display screens and on the system status screen.

The Organization column shows the primary service provider (generally a Distributor).

The Group column generally refers to the rig owner, and the Description column is a free-form field to identify a specific IS30 (e.g., by rig name, as shown below).

The Status column indicates which systems are online and if any remote users are connected to the machine.

Device	Groups	Service Enabled	Autorenew	VPN Status	Actions
AnybusTesting	FOAM DIST.	☑	⊙	A2Z Spray Foam	⋮ RIG 1
Ex710V4.5	FOAM DIST.	☑	⊙	A2Z Spray Foam	⋮ RIG 2
IS30-15044	FOAM DIST.	☑	⊙	A2Z Spray Foam	⋮ RIG 3
IS30-OilTestSt...	FOAM DIST.	☑	⊙	A2Z Spray Foam	⋮ RIG 4
IS30-PitDemo...	FOAM DIST.	☑	⊙	A2Z Spray Foam	⋮ RIG 5
IS40-OilTestSt...	FOAM DIST.	☑	⊙	A2Z Spray Foam	⋮ RIG 6
PumpStation3	FOAM DIST.	☑	⊙	A2Z Spray Foam	⋮ RIG 7

### STEP 2. Open IS30 Connection

Clicking on a Device in the first column creates a secure connection to that system and allows the user to select either a full or simplified interface.

The remote user sees and uses the actual IntelliSpray screens via a Virtual Network Connection (VNC icon) when using the full interface.

The simplified interface (HTTPS icon) is a direct peer-to-peer interface that allows monitoring and/or controlling the system's primary functions.

Endpoint	Application	Status
gateway	SSH	●
gateway	VNC	●
Secure Web Interface	Open the web interface over a secured connection (HTTPS) in a browser	●
VNC	VNC	●

Legend: ● Active ● Busy ● Inactive

Each IntelliSpray Proportioner is factory-equipped with an internal cellular modem that enables remote access to operate, monitor, update, and/or service the system.



Access by registered users (see previous page) is via any computer, phone, or tablet equipped with a standard browser (e.g., IE, Chrome, Safari).

The cellular modem also allows users to email Job Reports and performance data to selected recipients.



Full Interface (VNC) access on the phone

When powered on and within cell coverage, the IntelliSpray Proportioner automatically connects to the internet. No user interaction is required to connect the Proportioner to the internet.

Initial cellular fees (up to 12 months) are included in the purchase price, with ongoing rates subject to purchase and /or service agreements.



Simplified Interface (HTTPS) remote access on the computer, phone, or tablet

The remote access capabilities of the IntelliSpray Proportioner enable service providers to connect to any system and provide assistance in remote diagnostics, application optimization, remote software upgrades, and system use training.



Full Interface (VNC) access on the computer

Users can call or text their authorized support contact to initiate a remote support session. If escalation to second- and third-level support staff is required, those individuals can also connect with the Proportioner.

All parties can simultaneously connect to a Proportioner if required to resolve issues or answer questions. Note: A user does not have to be in the spray rig to initiate a remote service event, but the IS30 must be powered on and within the cell range to establish a remote connection.

When a user calls or texts their authorized service provider, that provider can remotely access the IntelliSpray Proportioner and, in some cases, resolve the issue without the user leaving the spray environment.

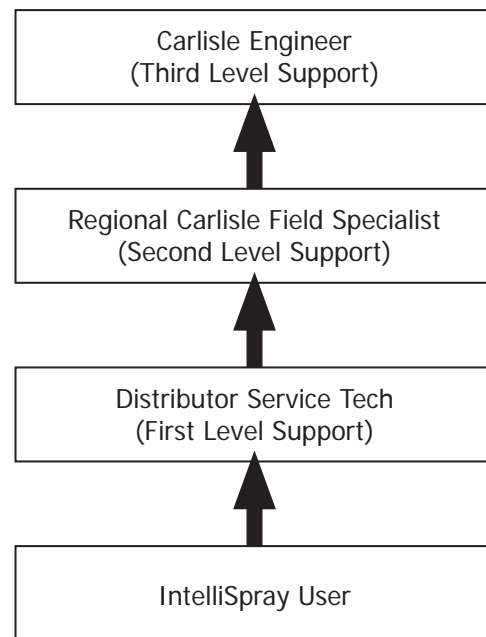



This page intentionally left blank.

**MANUAL CHANGE SUMMARY**

Date	Description	Version
12/01/2022	Initial release.	A
12/21/2022	Updated electrical schematics.	A
03/13/2023	Updated images and expanded instructions.	A
11/15/2023	Formatting changes to the document. Added 400V model configuration.	B

This page intentionally left blank.

## WARRANTY POLICY

This product is covered by Carlisle Fluid Technologies' materials and workmanship limited warranty.

The use of parts or accessories from sources other than Carlisle Fluid Technologies will void all warranties. Failure to follow reasonable maintenance guidance provided can invalidate the warranty.

For specific warranty information, please contact Carlisle Fluid Technologies.

For technical assistance or to locate an authorized distributor, contact one of our international sales and customer support locations listed below.

REGION	INDUSTRIAL/ AUTOMOTIVE	AUTOMOTIVE REFINISHING
Americas	Tel: 1-800-992-4657 Fax: 1-888-246-5732	Tel: 1-800-445-3988 Fax: 1-800-445-6643
Europe, Africa Middle East, India	Tel: +44 (0)1202 571 111 • Fax: +44 (0)1202 573 488	
China	Tel: +8621-3373 0108 • Fax: +8621-3373 0308	
Japan	Tel: +81 45 785 6421 • Fax: +81 45 785 6517	
Australia	Tel: +61 (0) 2 8525 7555 • Fax: +61 (0) 2 8525 7575	





Carlisle Fluid Technologies is a global leader in innovative finishing technologies.

Carlisle Fluid Technologies reserves the right to modify equipment specifications without prior notice.

BGK™, Binks®, DeVilbiss®, Hosco®, MS®, and Ransburg® are registered trademarks of Carlisle Fluid Technologies, LLC.